

# **PARTICIPANT BUILD PACK 1**

## **PROCESS FLOW DIAGRAMS VER 3.6**

## **TABLE OF TRANSACTIONS VER 3.5**

PREPARED BY: MARKET DEVELOPMENT  
DOCUMENT REF: 305196  
VERSION: 3.6  
DATE: 29 September 2017  
FINAL :

# Document Approval and Acceptance

## AEMO Approval

This document has been prepared by:

<b>NAME:</b>	<b>NANDU DATAR</b>	
<b>Position:</b>	<b>Business Analyst</b>	
<b>Signature:</b>		<b>Date:</b>

This document has been reviewed and conforms with the authorised changes to the Gas Interface Protocol:

<b>NAME:</b>	<b>RUTH GUEST</b>	
<b>Position:</b>	<b>Manager, Regulatory</b>	
<b>Signature:</b>		<b>Date:</b>

This document has been reviewed and conforms to AEMO's regulatory obligations:

<b>NAME:</b>	<b>PETER GEERS</b>	
<b>Position:</b>	<b>Executive General Manager, Markets</b>	
<b>Signature:</b>		<b>Date:</b>

## Version History

VERSION.	DATE	AUTHOR(S)	CHANGES AND COMMENTS
3.0	01/07/10	S. Monaco	<ul style="list-style-type: none"> <li>• Ensure document complies with AEMO standard.</li> <li>• Replace references to MSOR with relevant NGR &amp; RMP references.</li> <li>• Update terminology to correspond with current usage and definitions.</li> <li>• Update acronyms to the current vernacular.</li> <li>• Update images</li> <li>• Add References to Predecessors</li> <li>• Diagram 2.0 – Remove process flows 2.18, 2.19 and 2.21 which related to an aseXML transaction interface between RB and DB for confirming current FRO. This aseXML transaction does not exist.</li> <li>• Diagram 2.0 – Process flow 2.12 to 2.27 which relates to an aseXML transaction called Meterdatahistory, which is not operational in aseXML. It is however operational as an email.</li> <li>• Diagram 4.0 – Remove the information bubble that made reference to reviewing Meter Route schedule being considered as an aseXML. This transaction continues to be made available via email.</li> <li>• Diagram 5.4 – Remove the information bubble that made reference to reviewing Meter Time Expired notice being considered as an aseXML. This transaction continues to be made available via email.</li> <li>• Diagram 13.1, 13.2A, 13.3 and 13.7 – yellow change marks as agreed in IN003/09 (CR96 – Minor RoLR Documentation Changes) have been included. A copy of the IN003/09 GMI is available from <a href="mailto:gcrf@aemo.com.au">gcrf@aemo.com.au</a></li> </ul>
3.1	30/07/12	S. Macri	<ul style="list-style-type: none"> <li>• IN011/12 (NECF Changes) Changes for Customer Classification</li> </ul>
3.2	01/02/13	J. Luu	<ul style="list-style-type: none"> <li>• IN029/12 Pilot Program BAU Process</li> </ul>
3.3	01/01/14	D. McGowan	<ul style="list-style-type: none"> <li>• IN004/12 – Redundant Provision and minor GIP and Spec Pack changes</li> </ul>
3.4	01/07/14	D. McGowan	<ul style="list-style-type: none"> <li>• IN017/13 – Gas Road Map. Service Orders Review. Remove diagrams 5.1 to 5.5, 99.3 and 99.4 and add new Process Flows diagrams 100 to 107</li> </ul>
3.5	31/07/17	N Datar	<ul style="list-style-type: none"> <li>• IN023/15, IN028/15 and IN029/15 Harmonisation and other minor changes</li> </ul>

3.6	29/09/2017	N Datar	<ul style="list-style-type: none"><li>IN039/16 Harmonisation of T900 Password Protection changes to Diagram 13.1</li></ul>
-----	------------	---------	--

## Executive Summary

The Table of Transactions version 3.5 contains: Table of Transactions, Table of Elements, List of Job Enquiry Codes, Address Elements and MIRN and Meter states.

Note: The Table of Transactions is a separate document and is not included in the electronic version of this document.

## References to Predecessors

To reflect the governance changes implemented on 1 July 2009, this document has been amended to remove references to the Victorian Energy Networks Corporation (VENCorp) and replace such references with Australian Energy Market Operator (AEMO). Where any content inadvertently refers to VENCorp it should be read as referring to AEMO.

It should be noted that participant ID "VENCORP" remains as the participant ID for AEMO as the gas market operator in Victoria and Queensland.

# Contents

1	Process Flow Diagrams .....	8
1.1	Process Flow Symbols .....	9
1.2	DIAGRAM 1.0 – SPECIAL METER READS .....	10
1.3	DIAGRAM 1.1 – SPECIAL METER READS CANCELLATION .....	11
1.4	DIAGRAM 2.0 – BM DATA COLLECTION AND DELIVERY (PAGE 1) .....	12
1.5	DIAGRAM 2.0 – BM DATA COLLECTION AND DELIVERY (PAGE 2) .....	13
1.6	DIAGRAM 2.7 – BASIC METER CUSTOMISATION BILL ESTIMATION .....	14
1.7	DIAGRAM 4.0 – BASIC METER ROUTE AND SITE INFORMATION .....	15
1.8	DIAGRAM 4.1 – CUSTOMER DETAILS NOTIFICATION.....	16
1.9	DIAGRAM 6.0 – CUSTOMER TRANSFER (PAGE 1) .....	17
1.10	DIAGRAM 6.0 – CUSTOMER TRANSFER (PAGE 2) .....	18
1.11	DIAGRAM 6.0 – CUSTOMER TRANSFER (PAGE 3) .....	19
1.12	DIAGRAM 6.0 – CUSTOMER TRANSFER (PAGE 4) .....	20
1.13	DIAGRAM 6.0 – CUSTOMER TRANSFER (PAGE 5) .....	21
1.14	DIAGRAM 6.0 – CUSTOMER TRANSFER (PAGE 6) .....	22
1.15	DIAGRAM 9.1 – BM DAILY CONSUMPTION ESTIMATION .....	23
1.16	DIAGRAM 10.0 – DATA CHANGE .....	24
1.17	DIAGRAM 11.0 – BASIC METER PROFILER (BMP) .....	25
1.18	DIAGRAM 12.0 – MIRN REQUEST .....	26
1.19	DIAGRAM 13.0 – CUSTOMER REQUEST TO RETAILER .....	27
2	RETAILER OF LAST RESORT PROCESS FLOWS.....	28
2.1	DIAGRAM 13.1 – PRE-ROLR EVENT – MONTHLY TRANSFER OF CUSTOMER DATA TO AEMO .....	28
2.2	DIAGRAM 13.2 – CATS PROCESSING – CANCELLED AND ACCELERATED CUSTOMER TRANSFERS .....	29
2.3	DIAGRAM 13.2A – CATS PROCESSING – ACCELERATED CUSTOMER TRANSFERS ('MOVE INS').....	30
2.4	DIAGRAM 13.3 – NON-CATS / CUSTOMER DATA EXCHANGE AND DATA GENERATION .....	31
2.5	DIAGRAM 13.4 – FRB GENERATED CUSTOMER LISTS FOR ROLR .....	32
2.6	DIAGRAM 13.5 – WHOLESALE PROCESS .....	33
2.7	DIAGRAM 13.6 – ROLR COMMUNICATIONS.....	34
2.8	DIAGRAM 13.7 – PROVISION OF ESTIMATE TRANSFER READS AND SUBSEQUENT ADJUSTMENT .....	35
2.9	DIAGRAM 13.8 – SERVICE ORDERS IN FLIGHT .....	36
3	PROCESS FLOW DIAGRAMS .....	37
3.1	DIAGRAM 99.1 – MAINS RENEWAL.....	37

3.2	DIAGRAM 99.2 – NETWORK BILLING .....	38
3.3	DIAGRAM 99.4 – MORN STANDING DATA UPDATE.....	39
3.4	DIAGRAM 99.5 – METERED SUPPLY POINT COUNT UPDATE .....	40
4	CUSTOMER CLASSIFICATION .....	41
4.1	DIAGRAM 99.9 – CUSTOMER REQUEST TO RETAILER .....	41
5	SERVICE ORDER PROCESS FLOWS .....	42
5.1	Diagram 100: Service Orders General (Simplified).....	42
5.2	Diagram 101: Retailer Initiated Service Orders Cancellation .....	43
5.3	Diagram 102: Distributor Initiated Service Orders.....	44
5.4	Diagram 103: Shipper Process.....	45
5.5	Diagram 104: Meter Fix Request.....	46
5.6	Diagram 105: Upgrade from Basic to Interval Meter .....	47
5.7	Diagram 106 : Downgrade from Interval to Basic Meter For tariff D.....	48
5.8	Diagram 107: Service Order Transaction Table.....	49

## 1 Process Flow Diagrams

1. These flow charts were developed as a working aid to development of the Retail Market Procedures (Victoria) and the Participant Build Packs for the purpose of identifying the necessary transactions between Retailers, Distributors and AEMO. Whilst reasonable effort has been made to ensure that these flow charts are updated and consistent with the Retail Market Procedures (Victoria) and the Participant Build Packs, there may be differences between the flow charts and the Retail Market Procedures (Victoria) and the Participant Build Packs. Where there is a difference, the Retail Market Procedures (Victoria) and the Participant Build Packs take precedence.
2. The process steps within individual business are indicative only and do not necessarily identify all required process steps nor do they mandate the use of a particular process.
3. The drawing conventions used for these diagrams are as follows:
  - a. Multiple flow arrows exiting from a process step indicate two or more independent process flows that occur following the step. If a flow is conditional, that condition will be noted on the flow arrow.
  - b. Alternative flows are indicated by a decision box containing a question. Conditions based on answers to the question on the flows exiting these boxes will be noted on the flow arrows.
  - c. A “fork” synch bar indicates two unconditional parallel processes that will rejoin at some point with a “join” synch bar. A join indicates that all processes must be completed before moving on.
4. Flow arrows that cross “swim lanes” to connect to a start or end identifier are used to ease diagram production and do not indicate a B2B transaction.



## 1.1 Process Flow Symbols

The drawing conventions used for these diagrams are as follows:

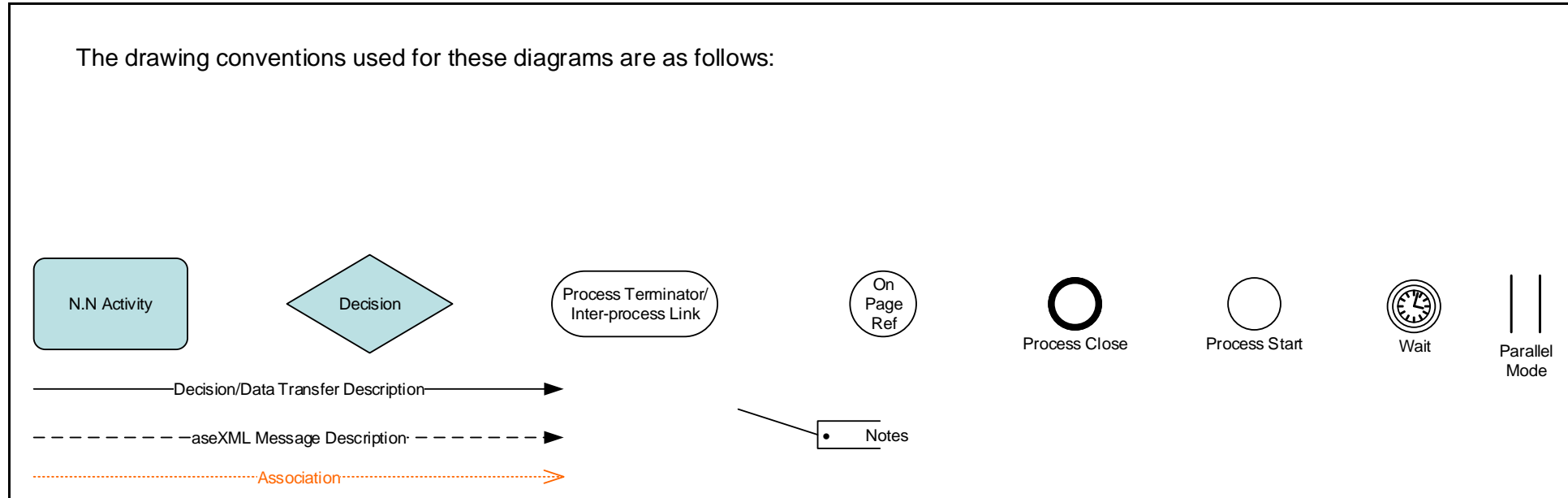

## 1.2 DIAGRAM 1.0 – SPECIAL METER READS

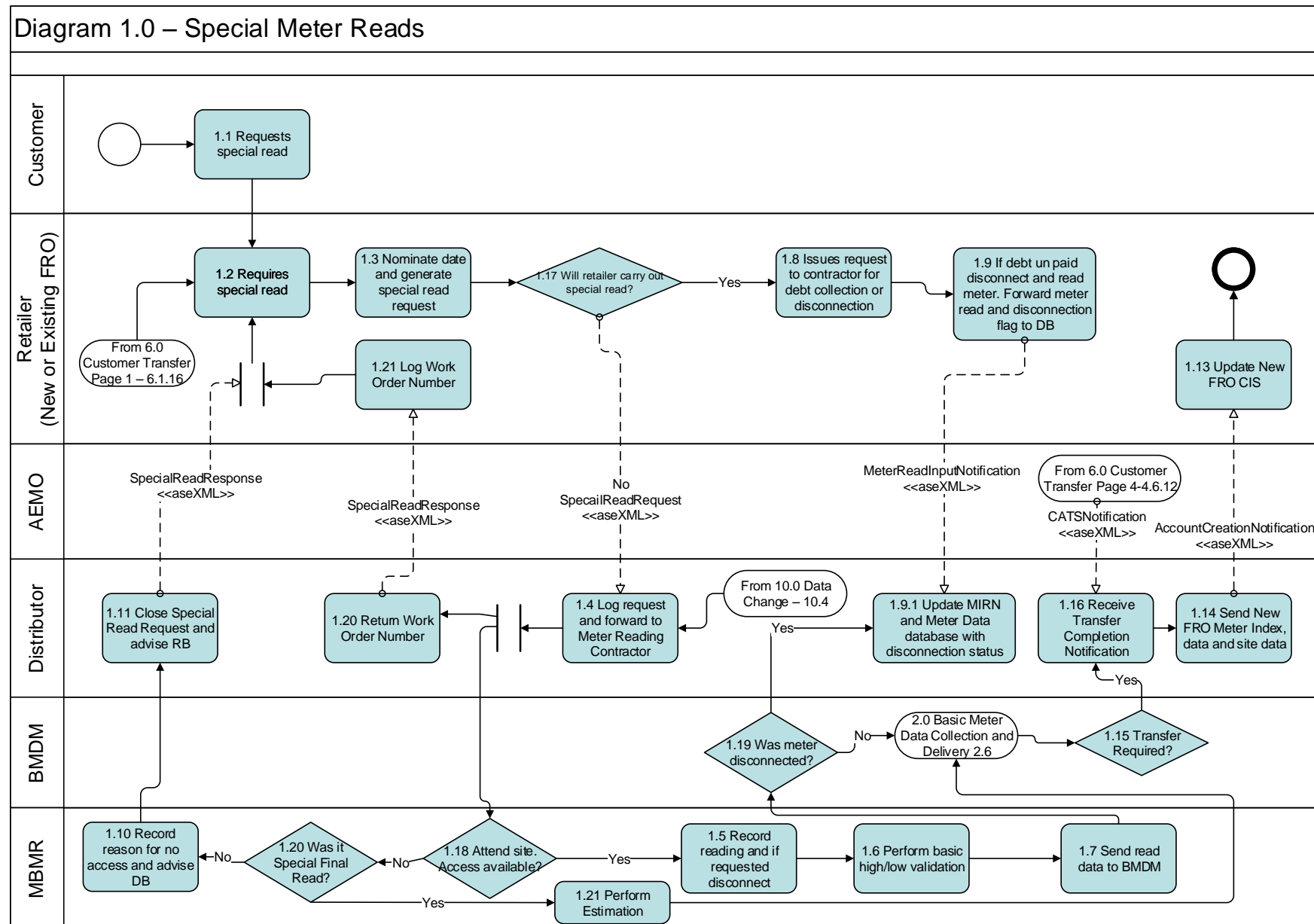

### 1.3 DIAGRAM 1.1 – SPECIAL METER READS CANCELLATION

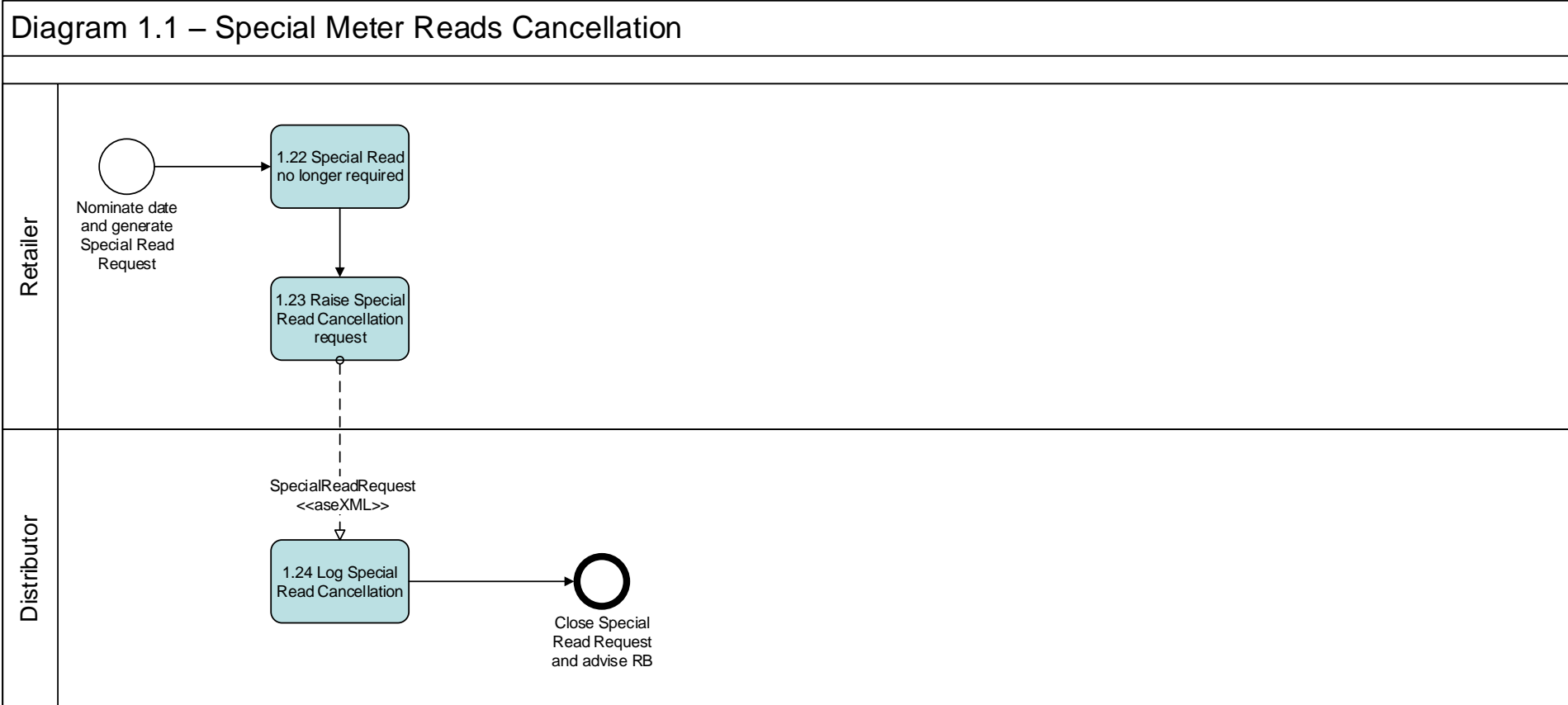

### 1.4 DIAGRAM 2.0 – BM DATA COLLECTION AND DELIVERY (PAGE 1)

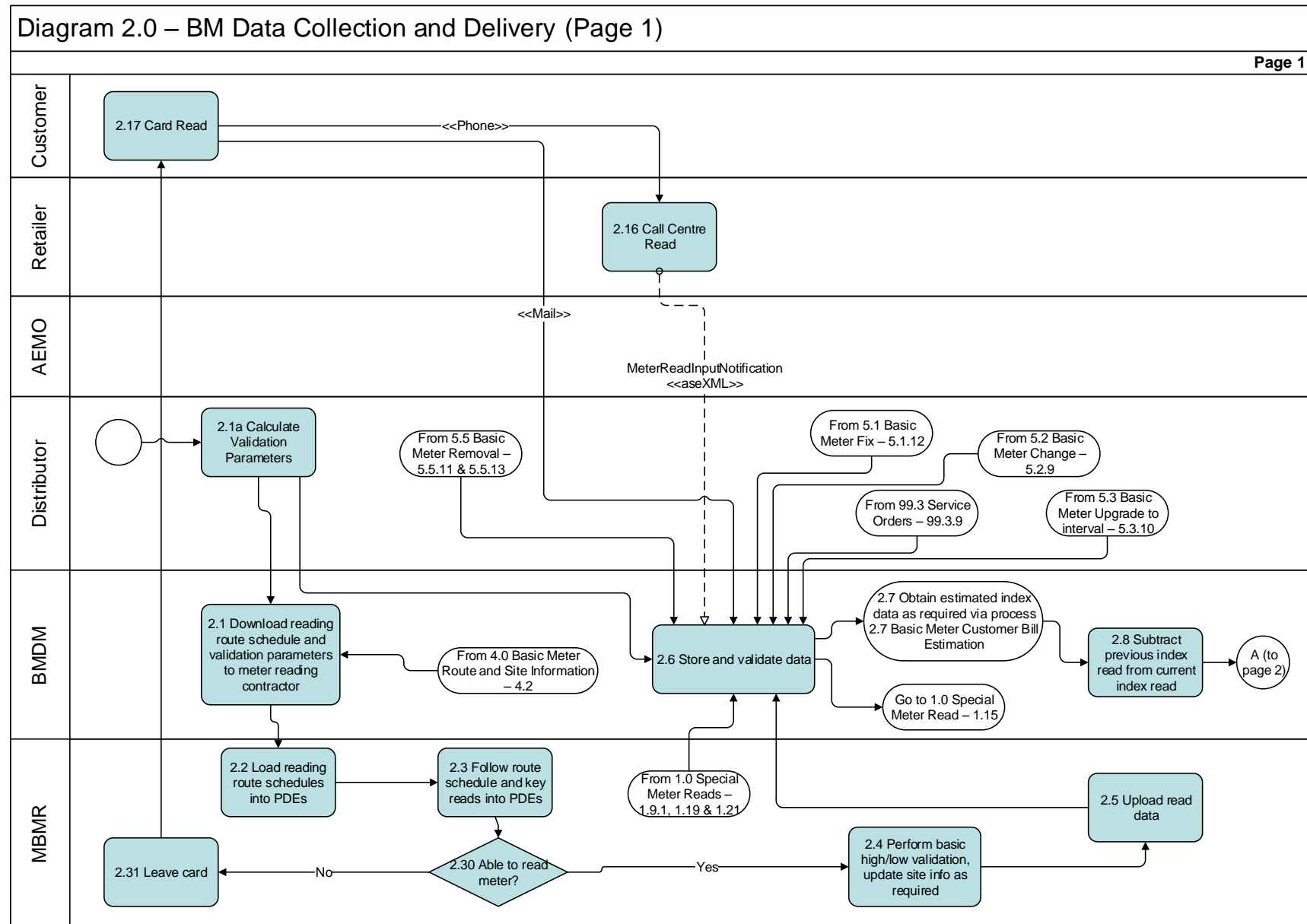

### 1.5 DIAGRAM 2.0 – BM DATA COLLECTION AND DELIVERY (PAGE 2)

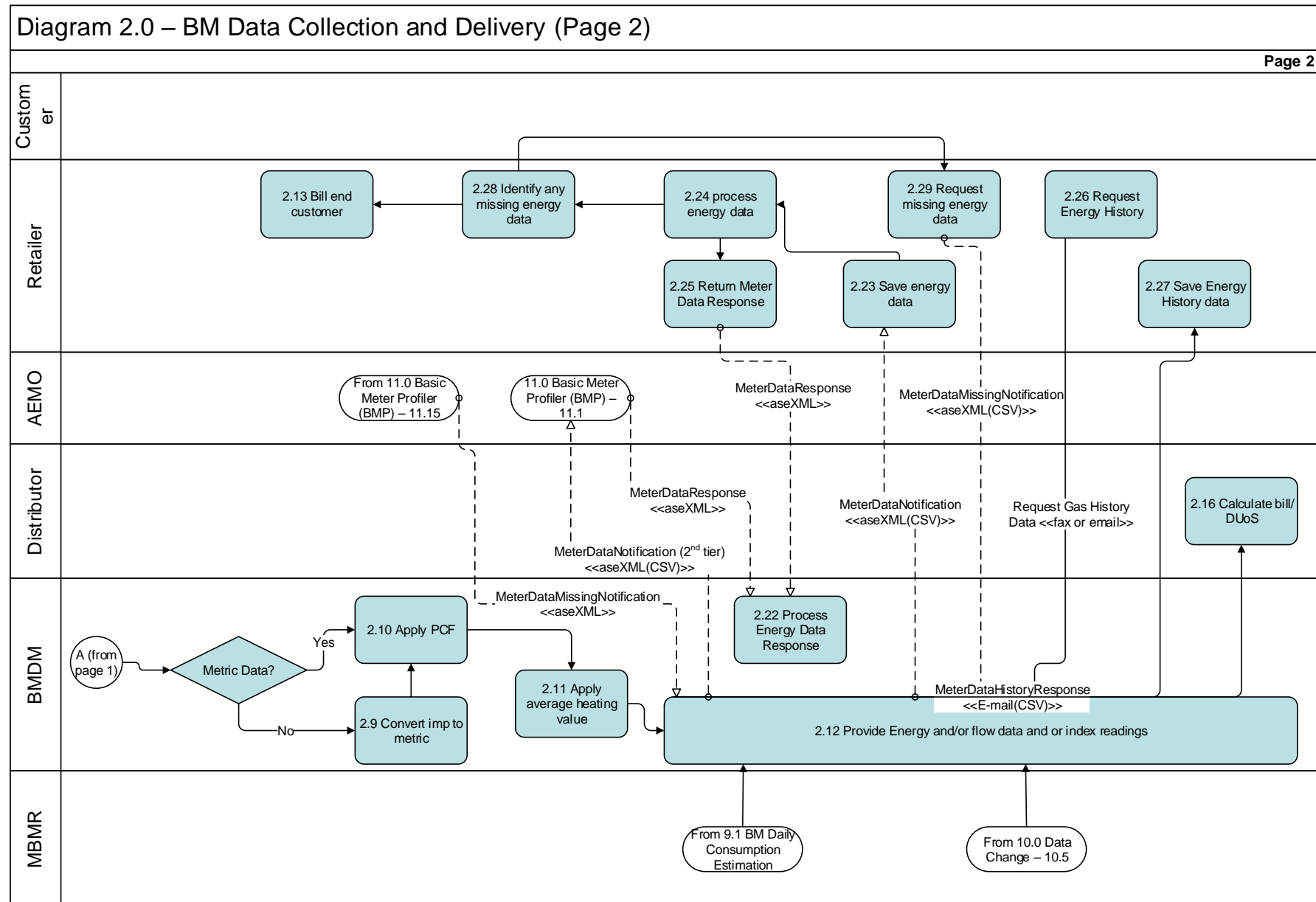

### 1.6 DIAGRAM 2.7 – BASIC METER CUSTOMISATION BILL ESTIMATION

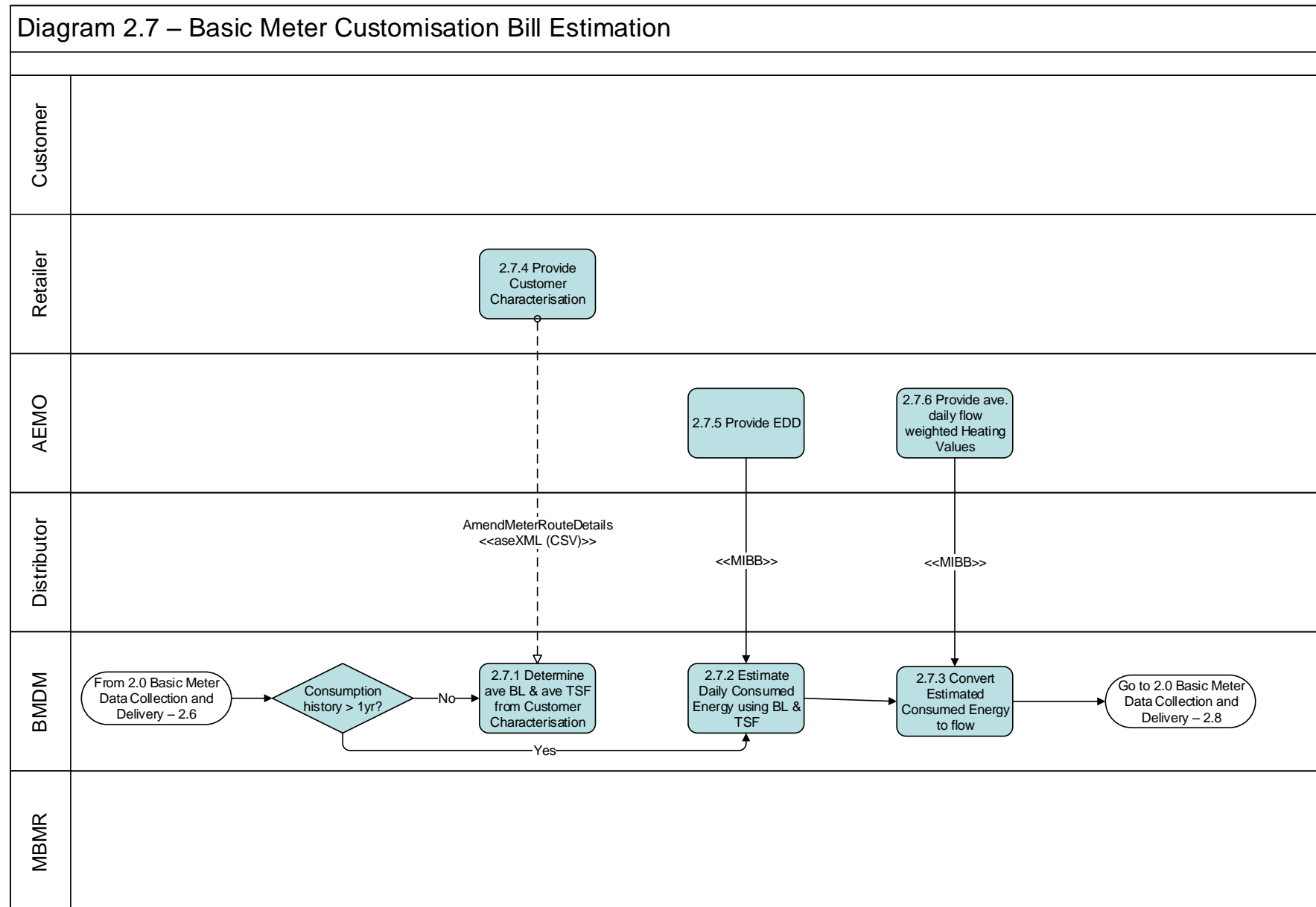

### 1.7 DIAGRAM 4.0 – BASIC METER ROUTE AND SITE INFORMATION

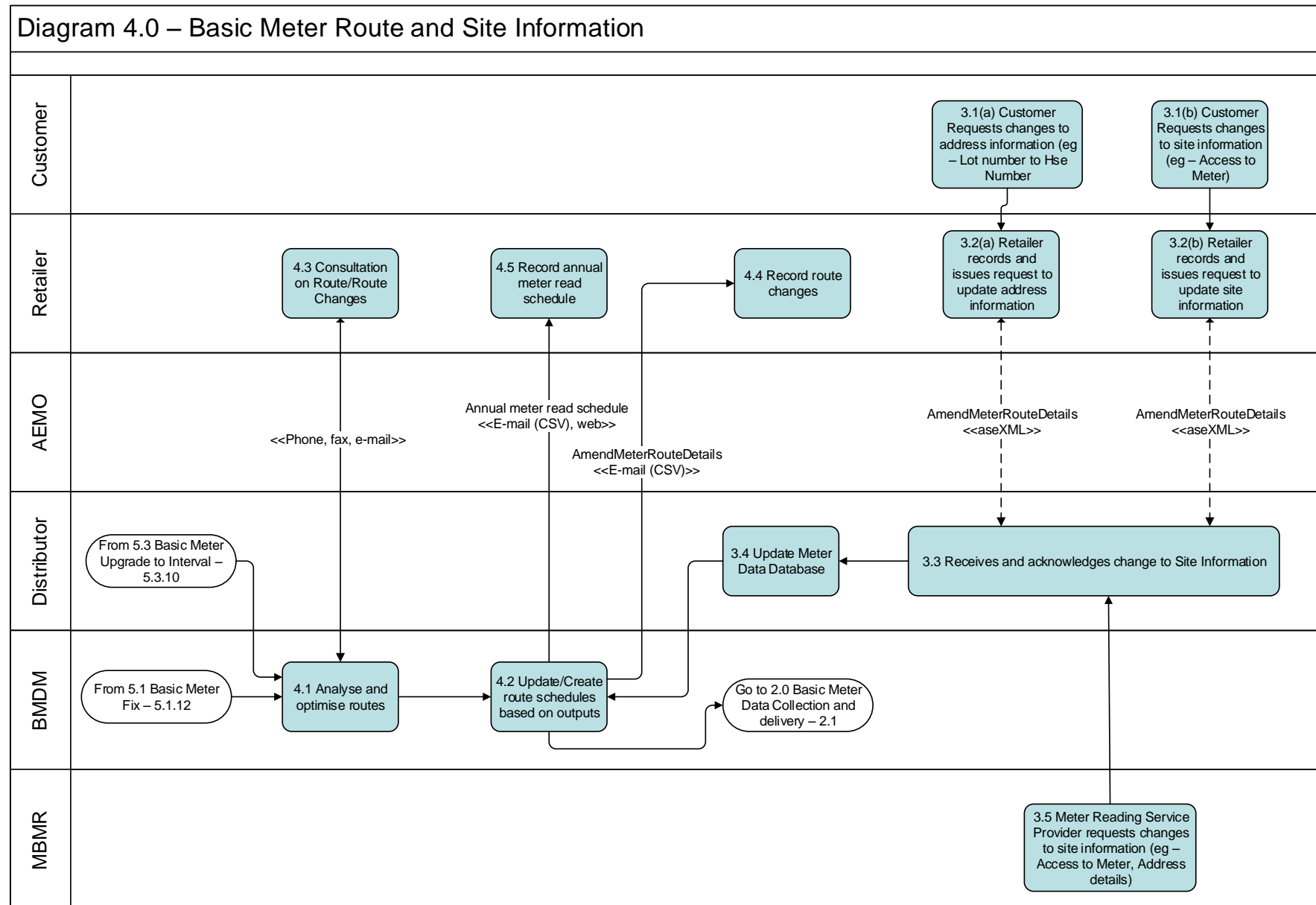

## 1.8 DIAGRAM 4.1 – CUSTOMER DETAILS NOTIFICATION

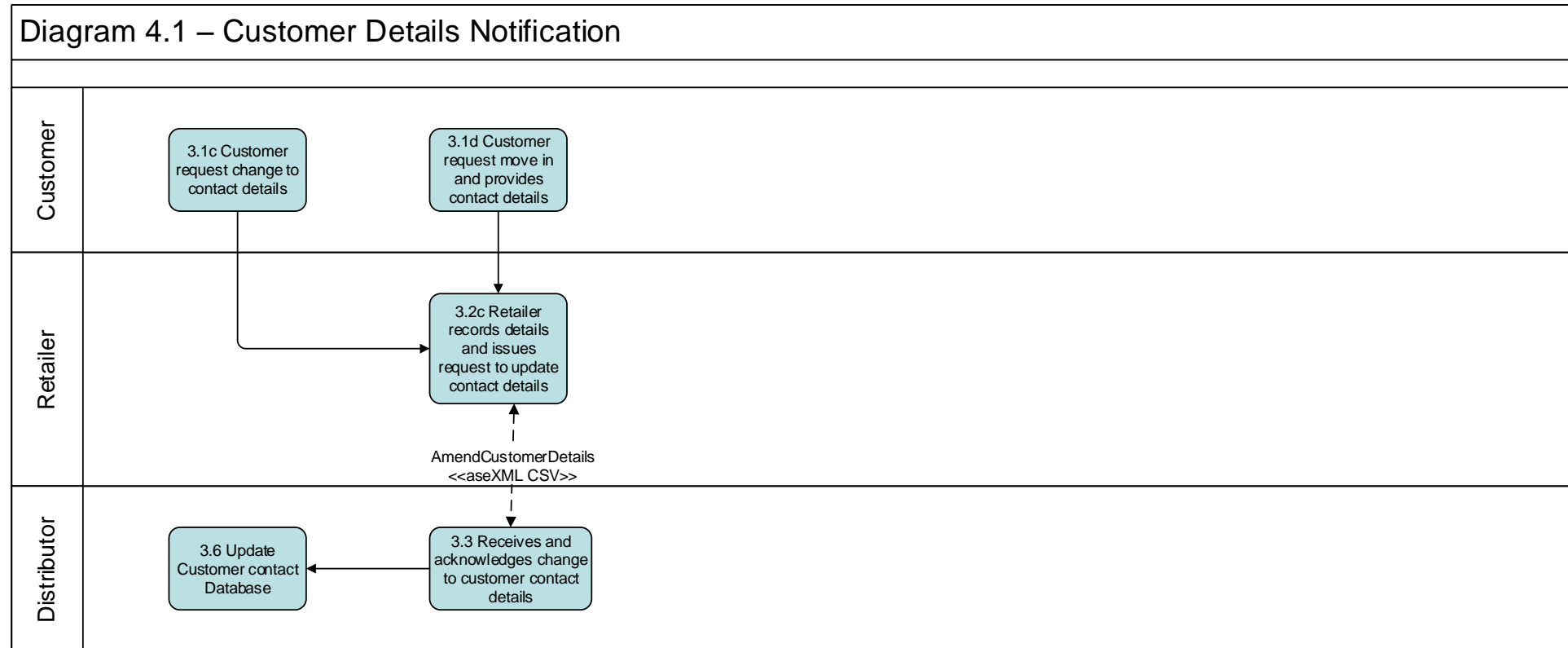



### 1.9 DIAGRAM 6.0 – CUSTOMER TRANSFER (PAGE 1)

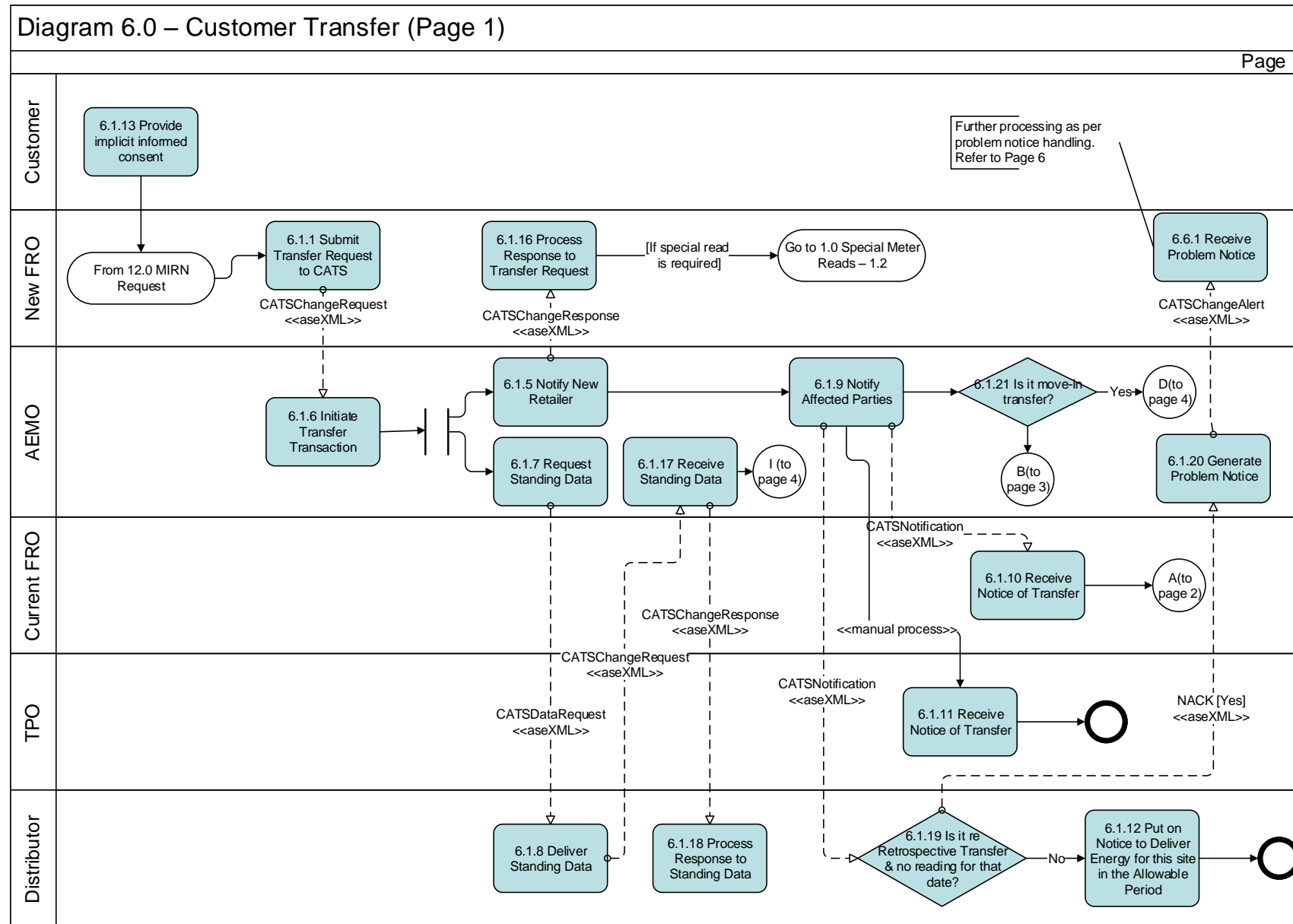

### 1.10 DIAGRAM 6.0 – CUSTOMER TRANSFER (PAGE 2)

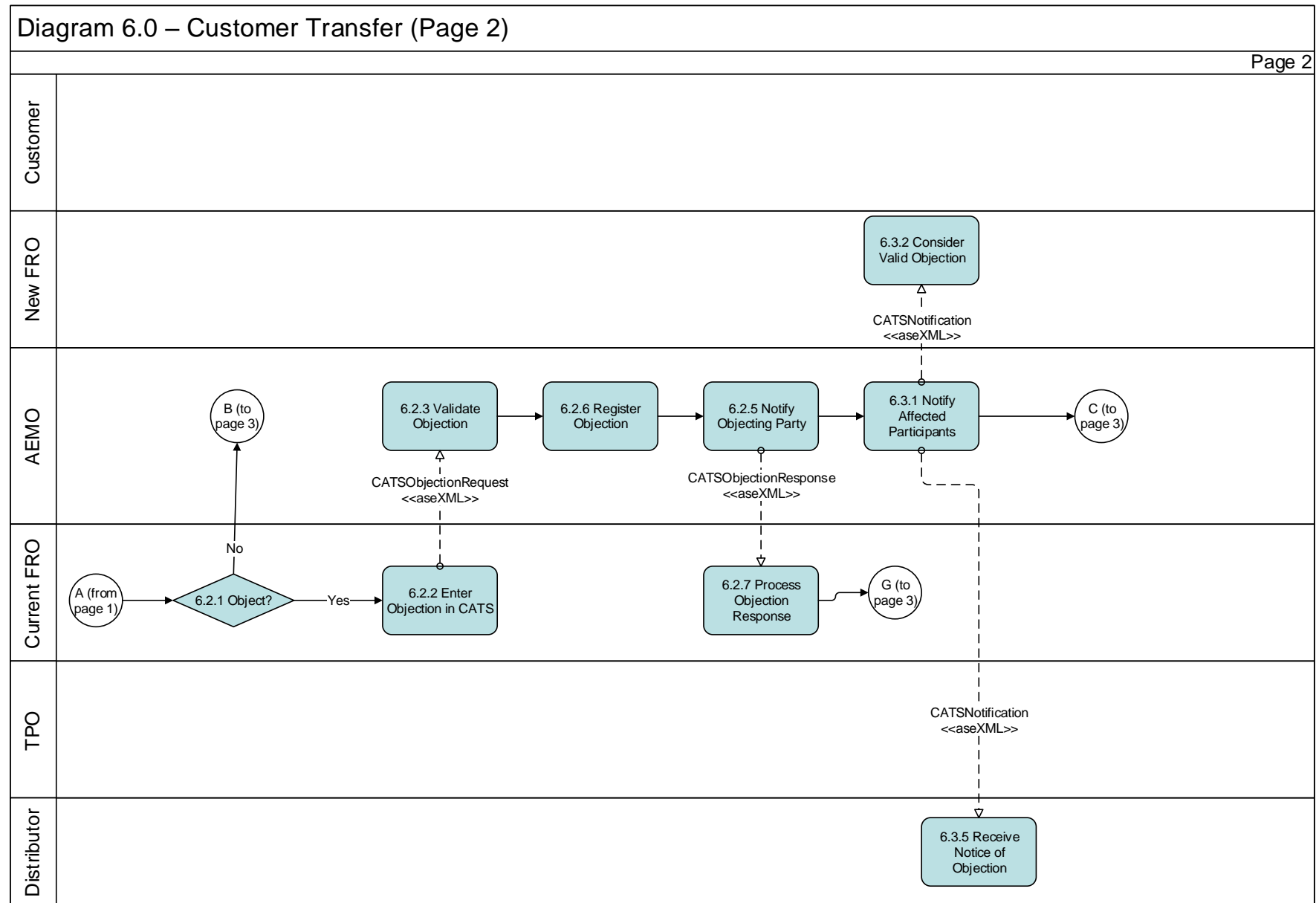

### 1.11 DIAGRAM 6.0 – CUSTOMER TRANSFER (PAGE 3)

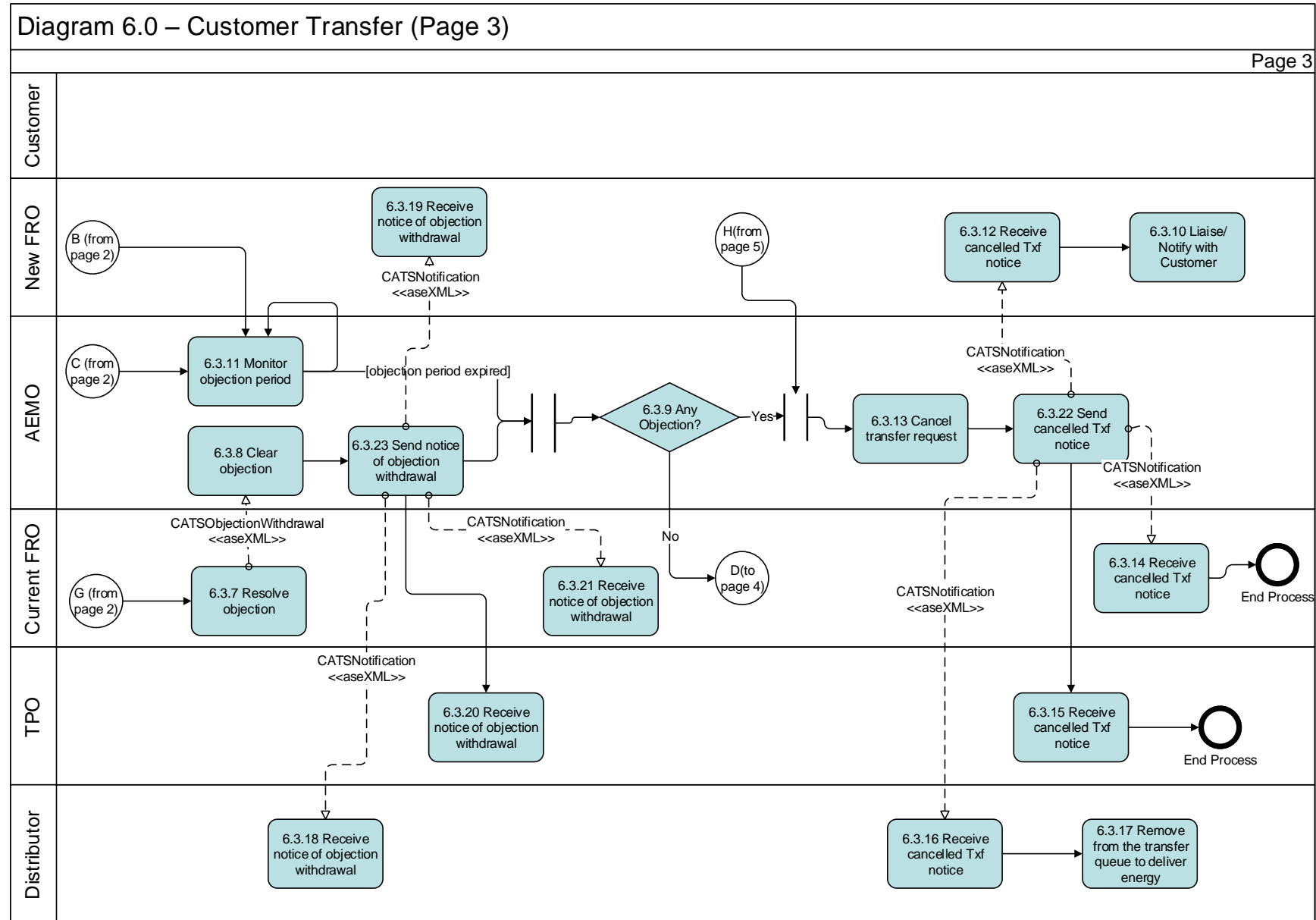

### 1.12 DIAGRAM 6.0 – CUSTOMER TRANSFER (PAGE 4)

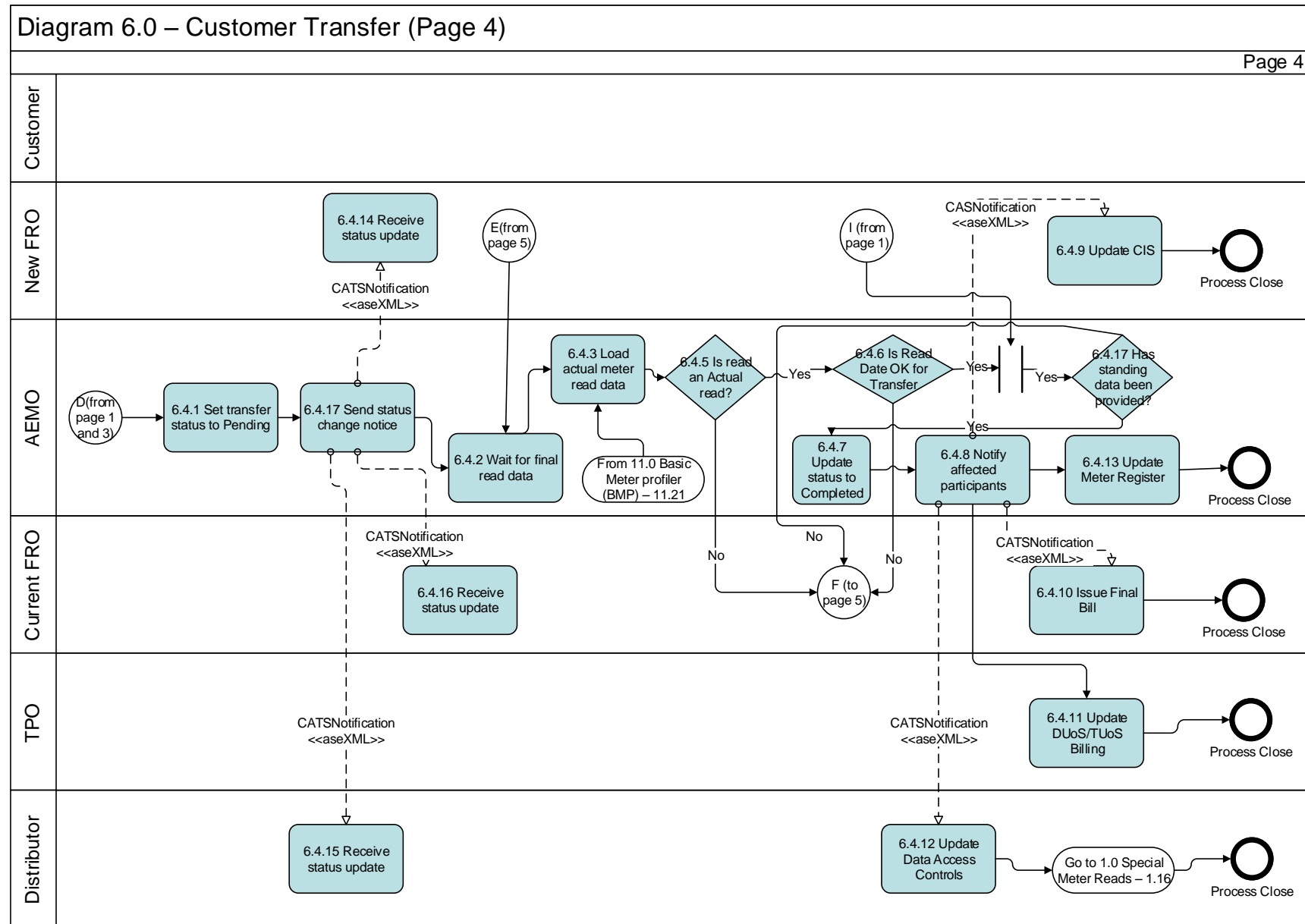

### 1.13 DIAGRAM 6.0 – CUSTOMER TRANSFER (PAGE 5)

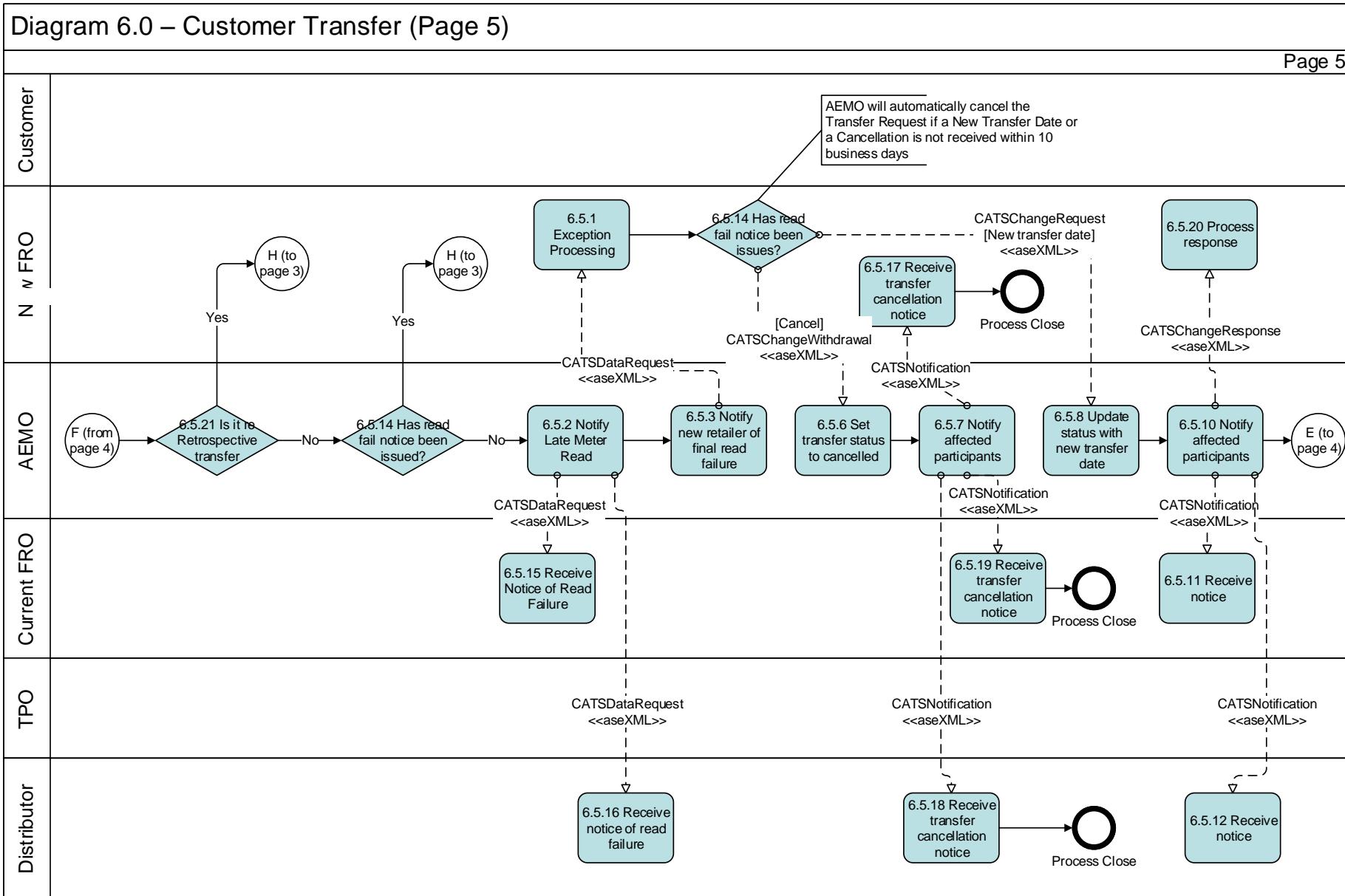

### 1.14 DIAGRAM 6.0 – CUSTOMER TRANSFER (PAGE 6)

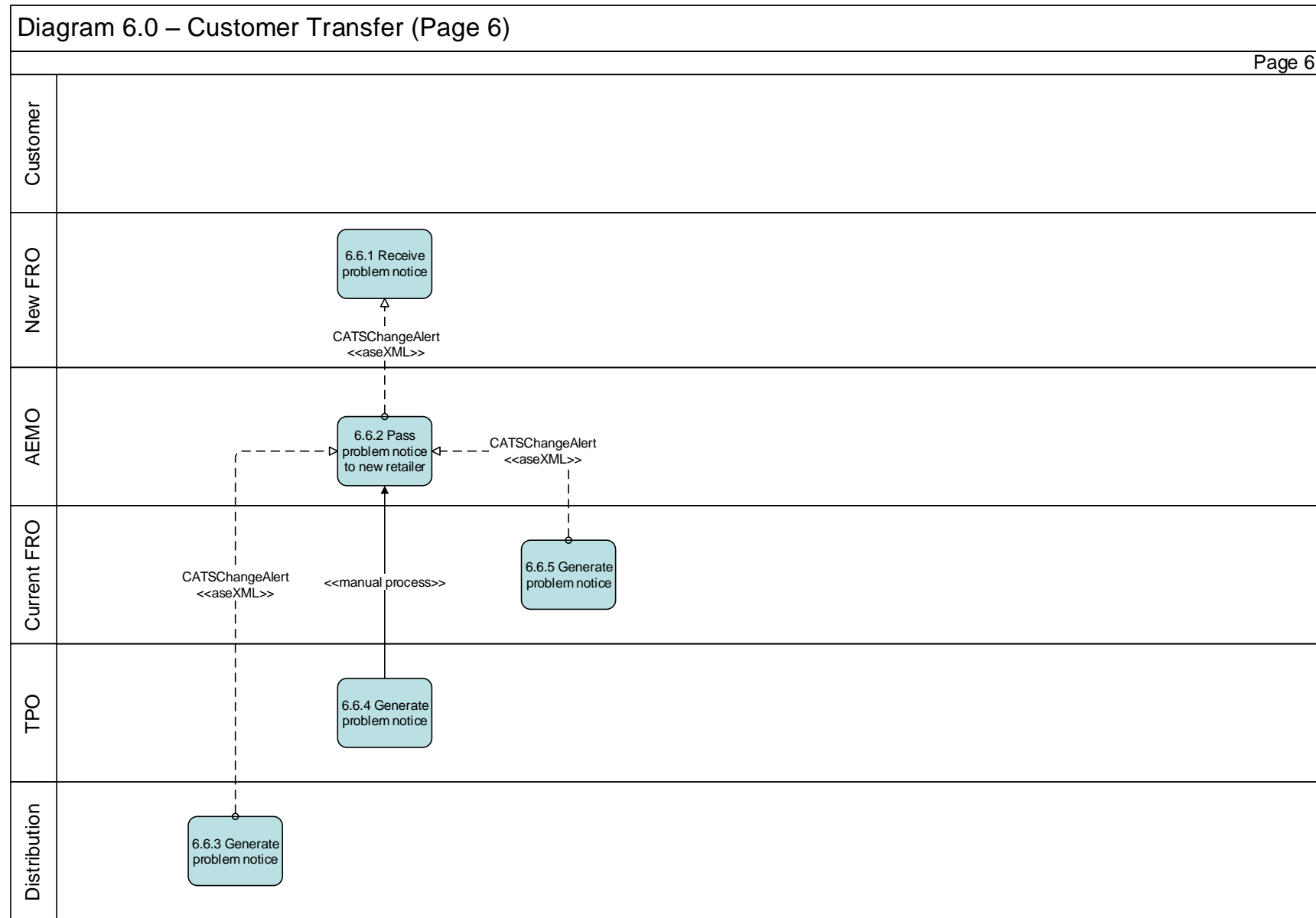

### 1.15 DIAGRAM 9.1 – BM DAILY CONSUMPTION ESTIMATION

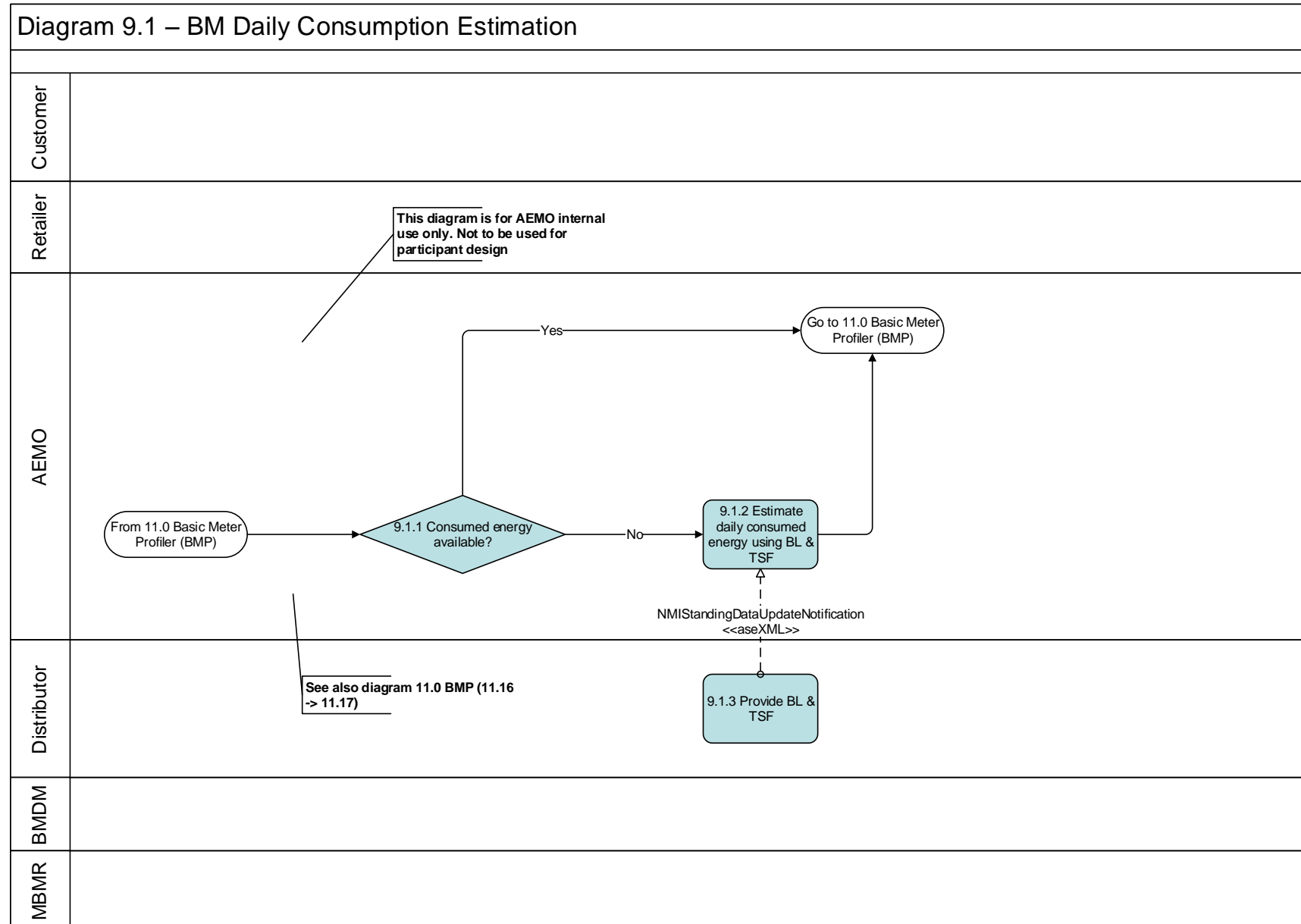

### 1.16 DIAGRAM 10.0 – DATA CHANGE

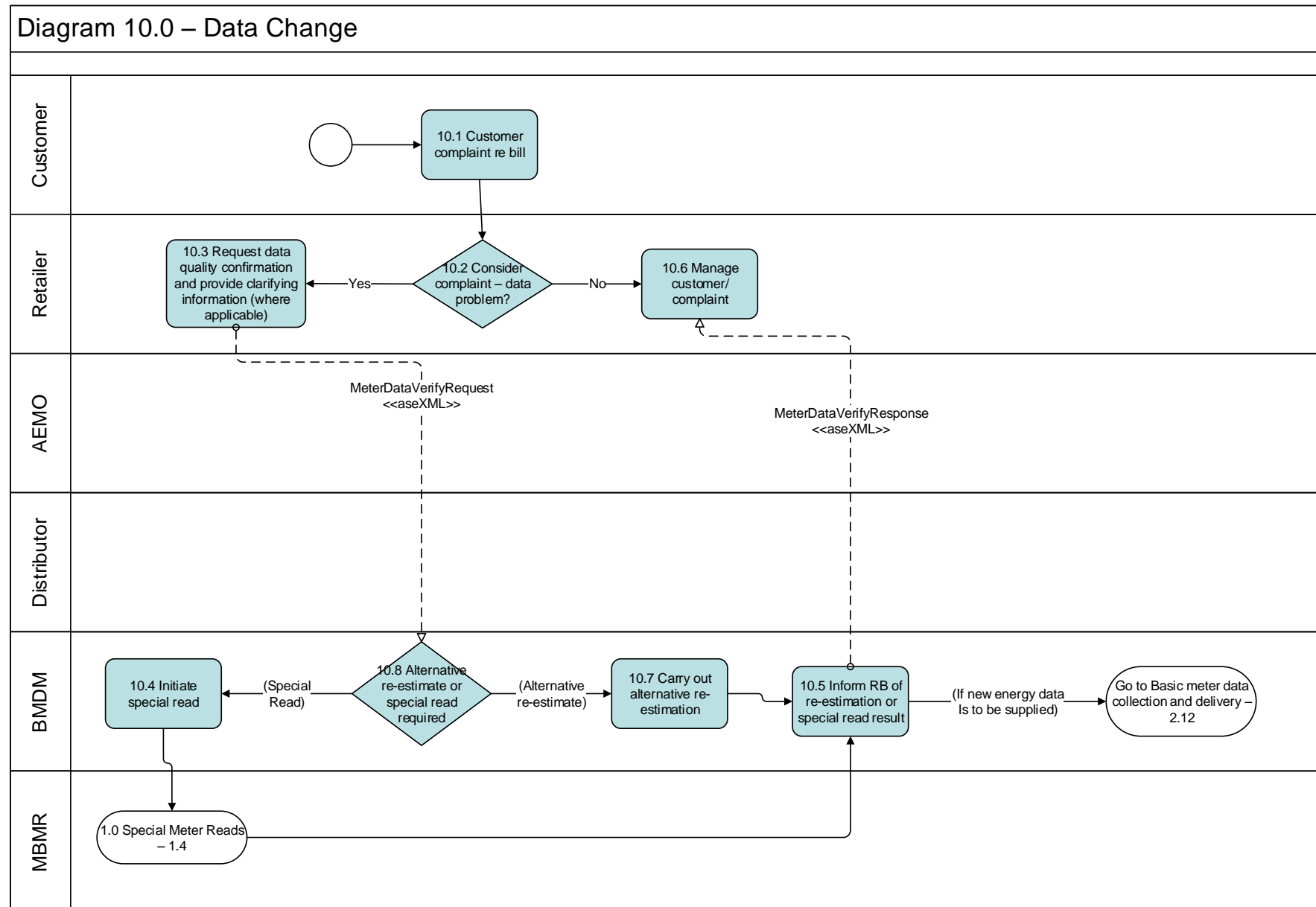



### 1.17 DIAGRAM 11.0 – BASIC METER PROFILER (BMP)

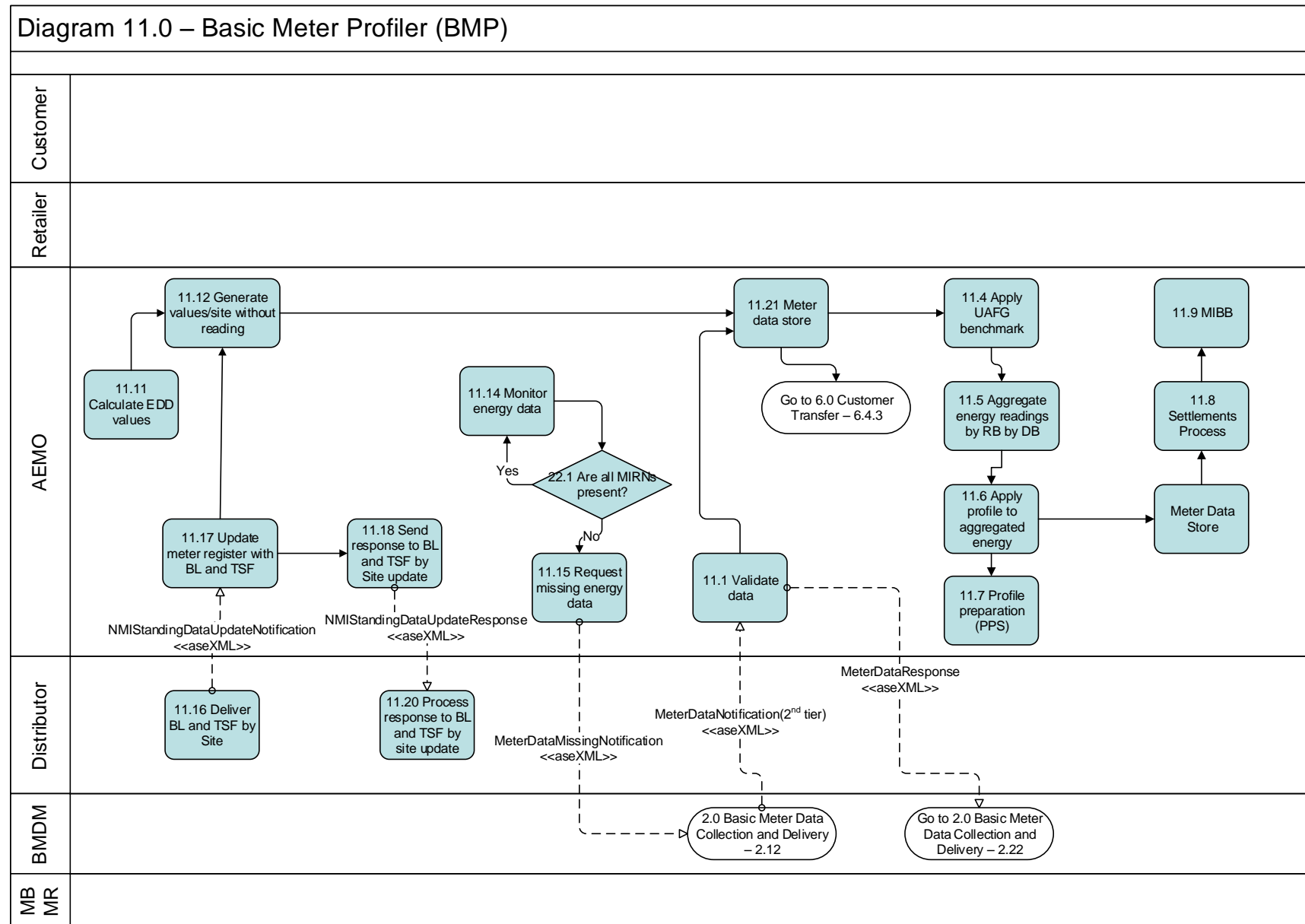

### 1.18 DIAGRAM 12.0 – MIRN REQUEST

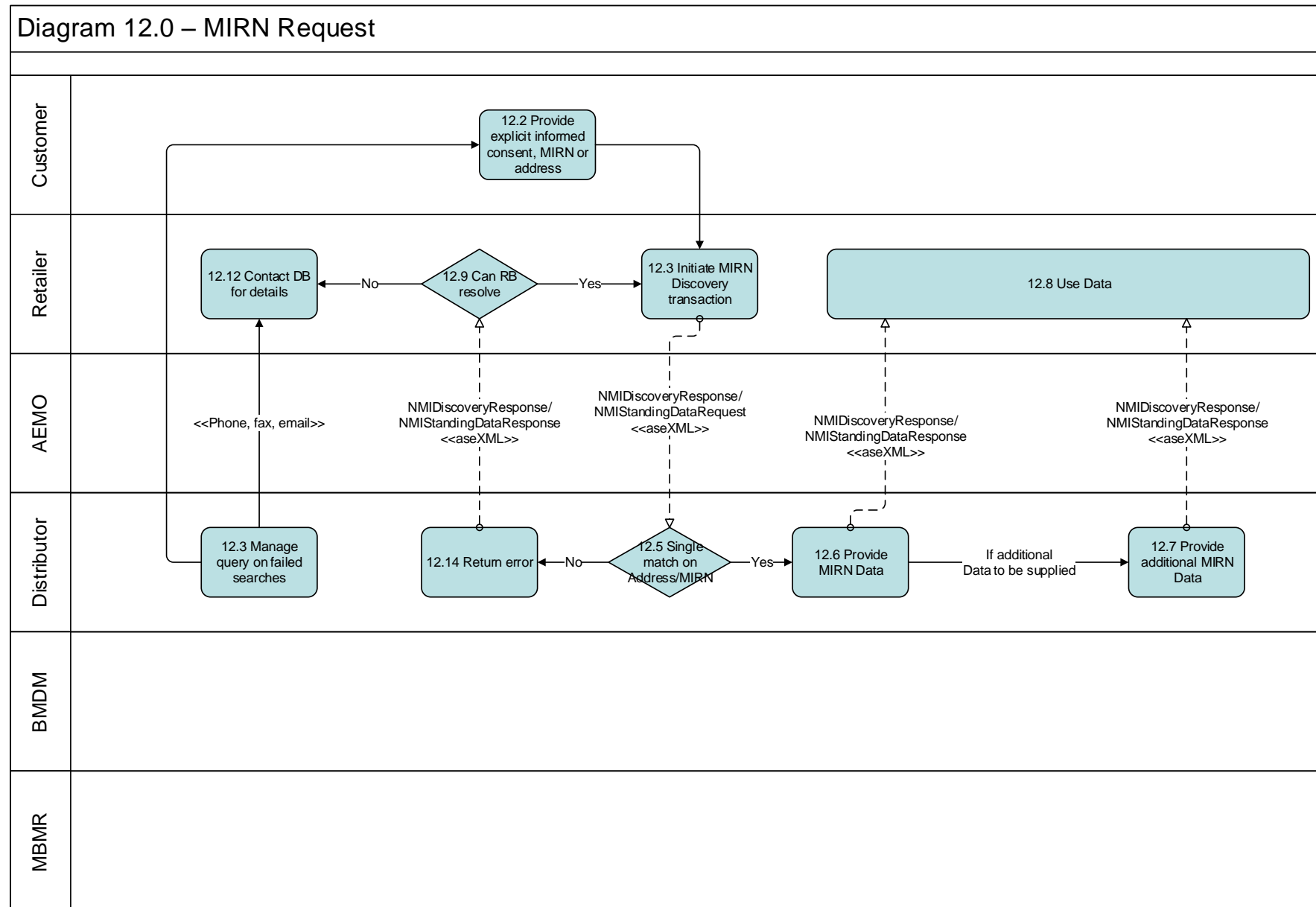

### 1.19 DIAGRAM 13.0 – CUSTOMER REQUEST TO RETAILER

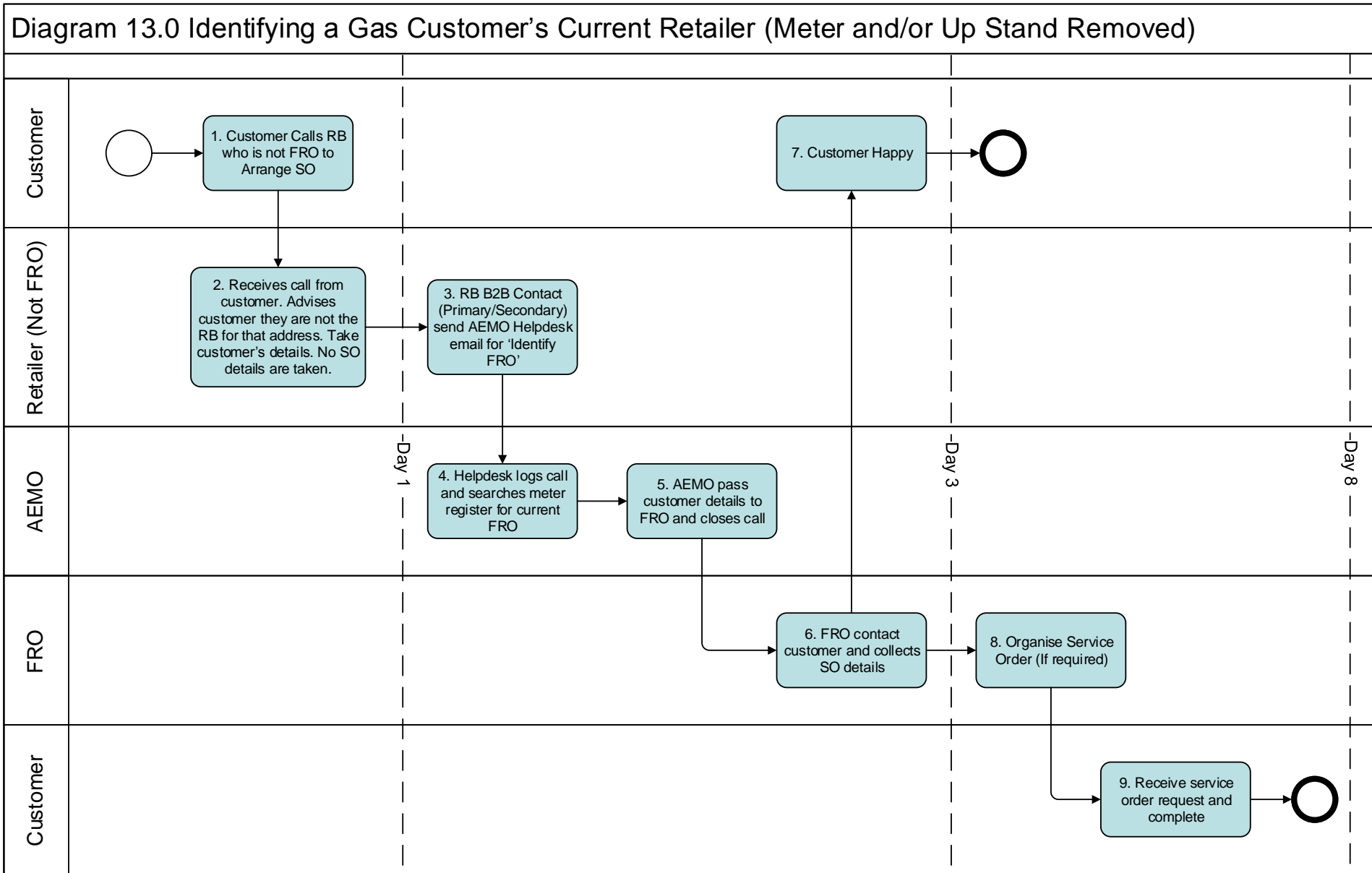

## 2 RETAILER OF LAST RESORT PROCESS FLOWS

### 2.1 DIAGRAM 13.1 – PRE-ROLR EVENT – MONTHLY TRANSFER OF CUSTOMER DATA TO AEMO

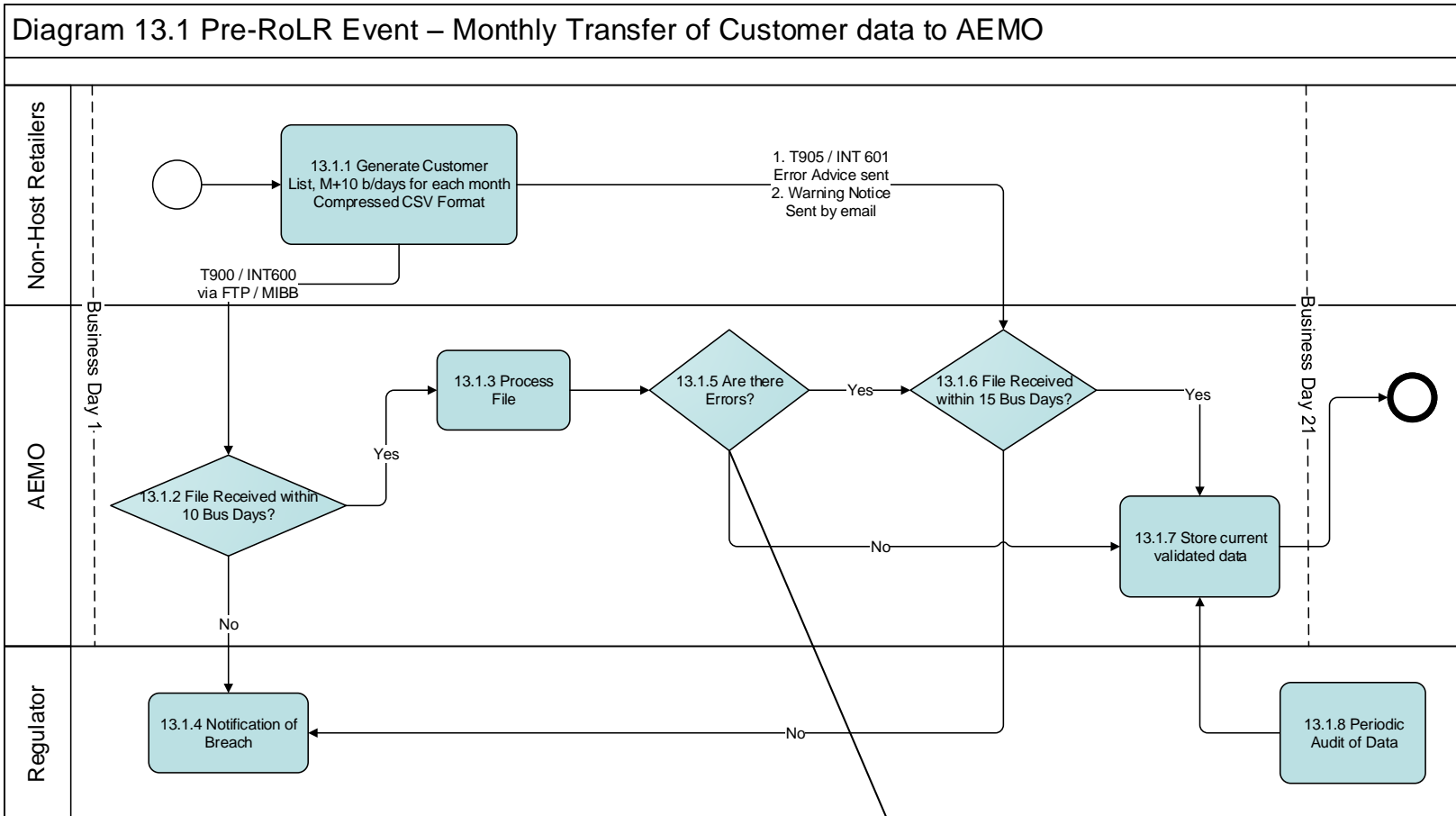

Errors include

- Validation against AEMO Meter Register to match MIRNs in AEMO Meter Register = <warning>
- Field contents where required / mandatory = <error>
- Archive old file as new file delivered and validate with no error
- For the avoidance of doubt – AEMO maintains current file in database only

## 2.2 DIAGRAM 13.2 – CATS PROCESSING – CANCELLED AND ACCELERATED CUSTOMER TRANSFERS

Diagram 13.2 - CATS Processing – Cancelled and Accelerated Customer Transfers (transfers Lodged in CATS)

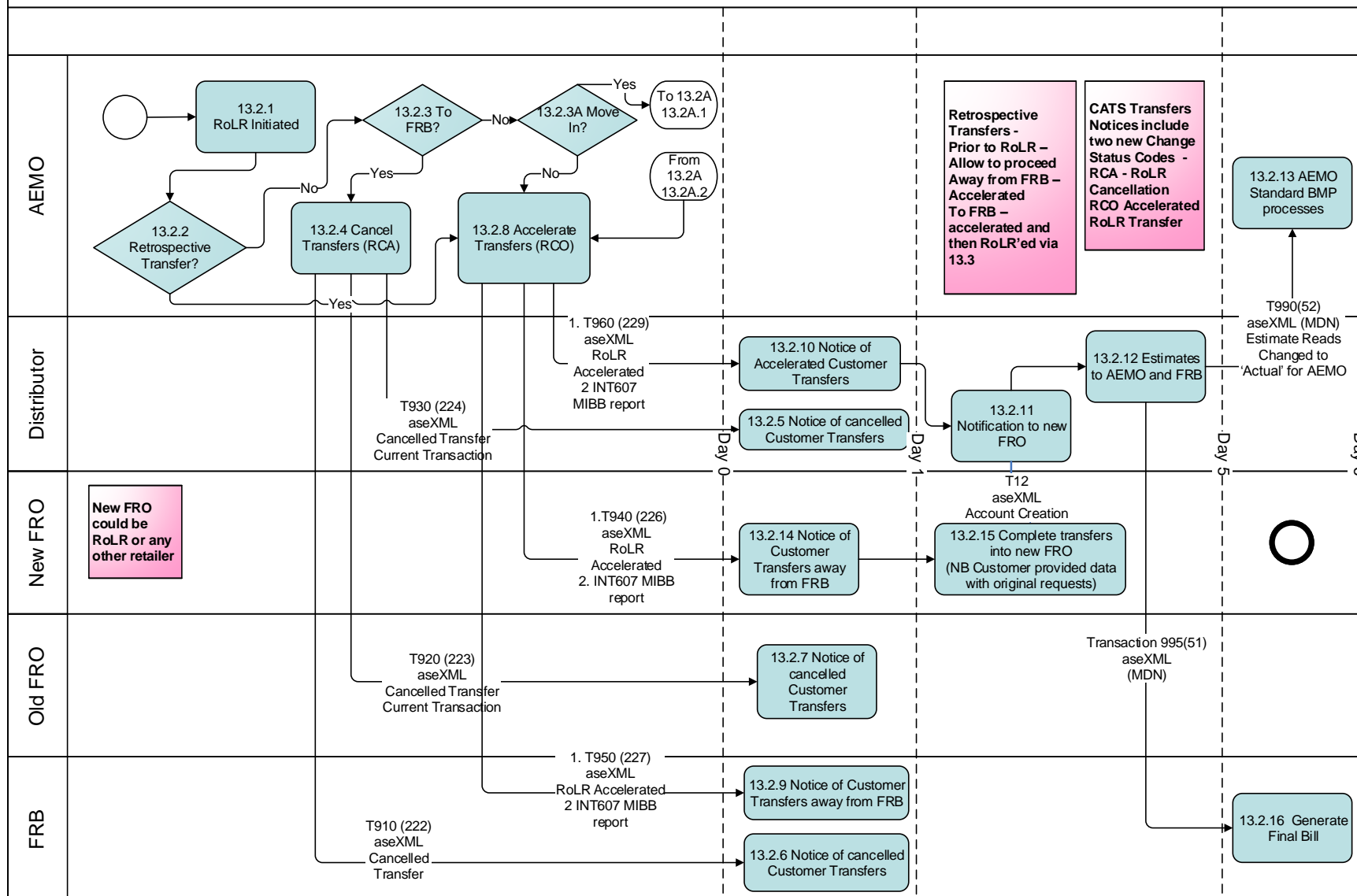

### 2.3 DIAGRAM 13.2A – CATS PROCESSING – ACCELERATED CUSTOMER TRANSFERS ('MOVE INS')

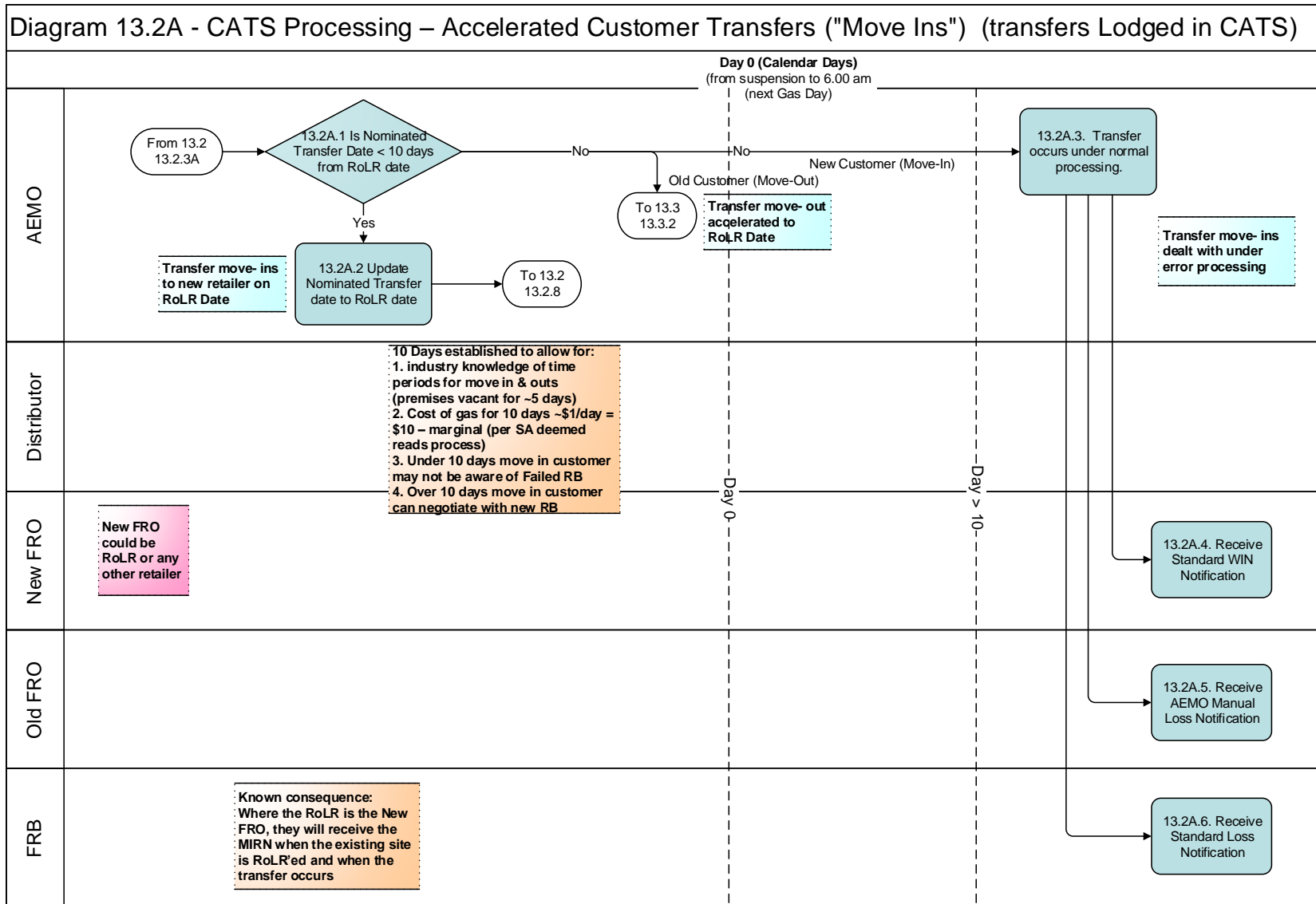

## 2.4 DIAGRAM 13.3 – NON-CATS / CUSTOMER DATA EXCHANGE AND DATA GENERATION

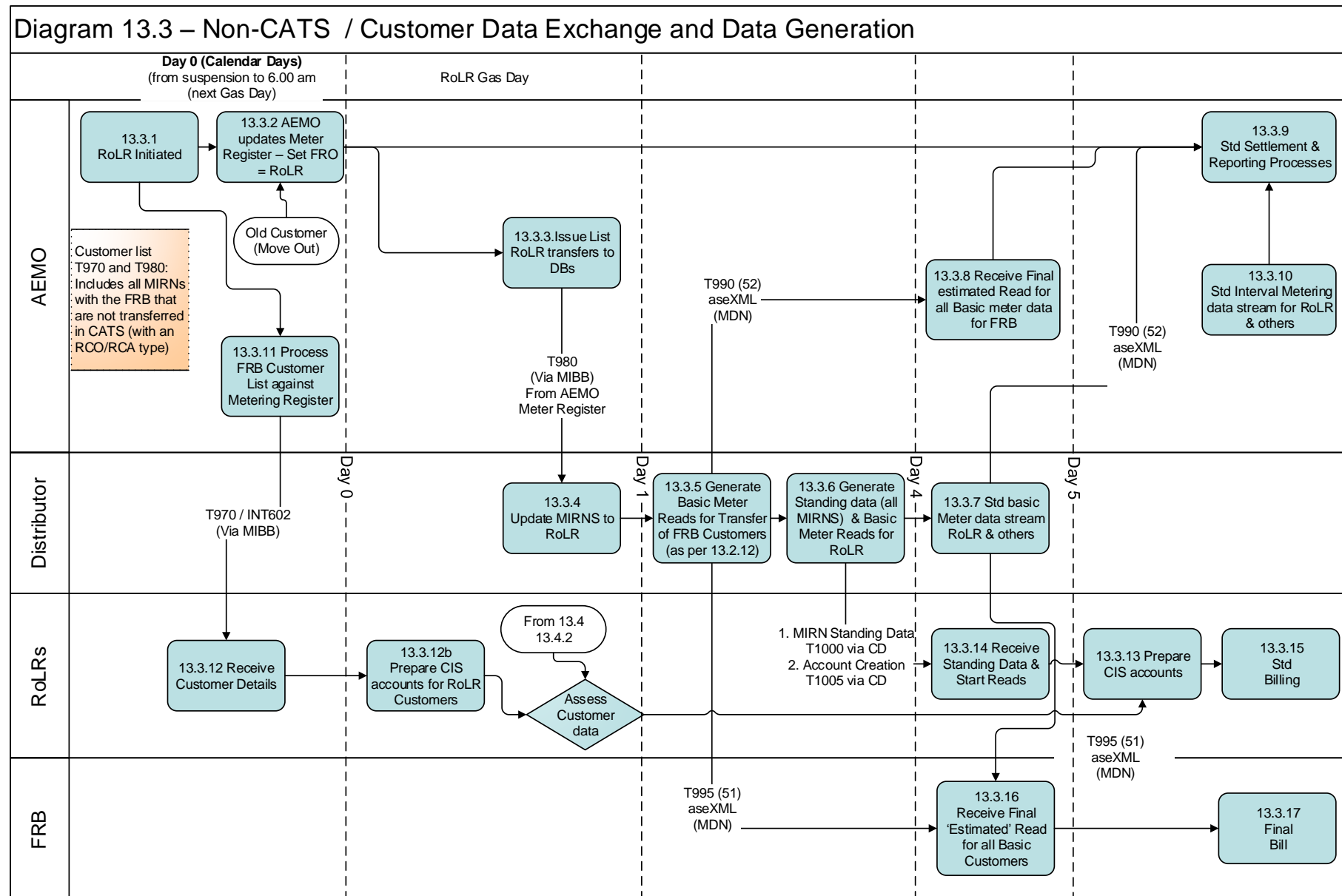

## 2.5 DIAGRAM 13.4 – FRB GENERATED CUSTOMER LISTS FOR ROLR

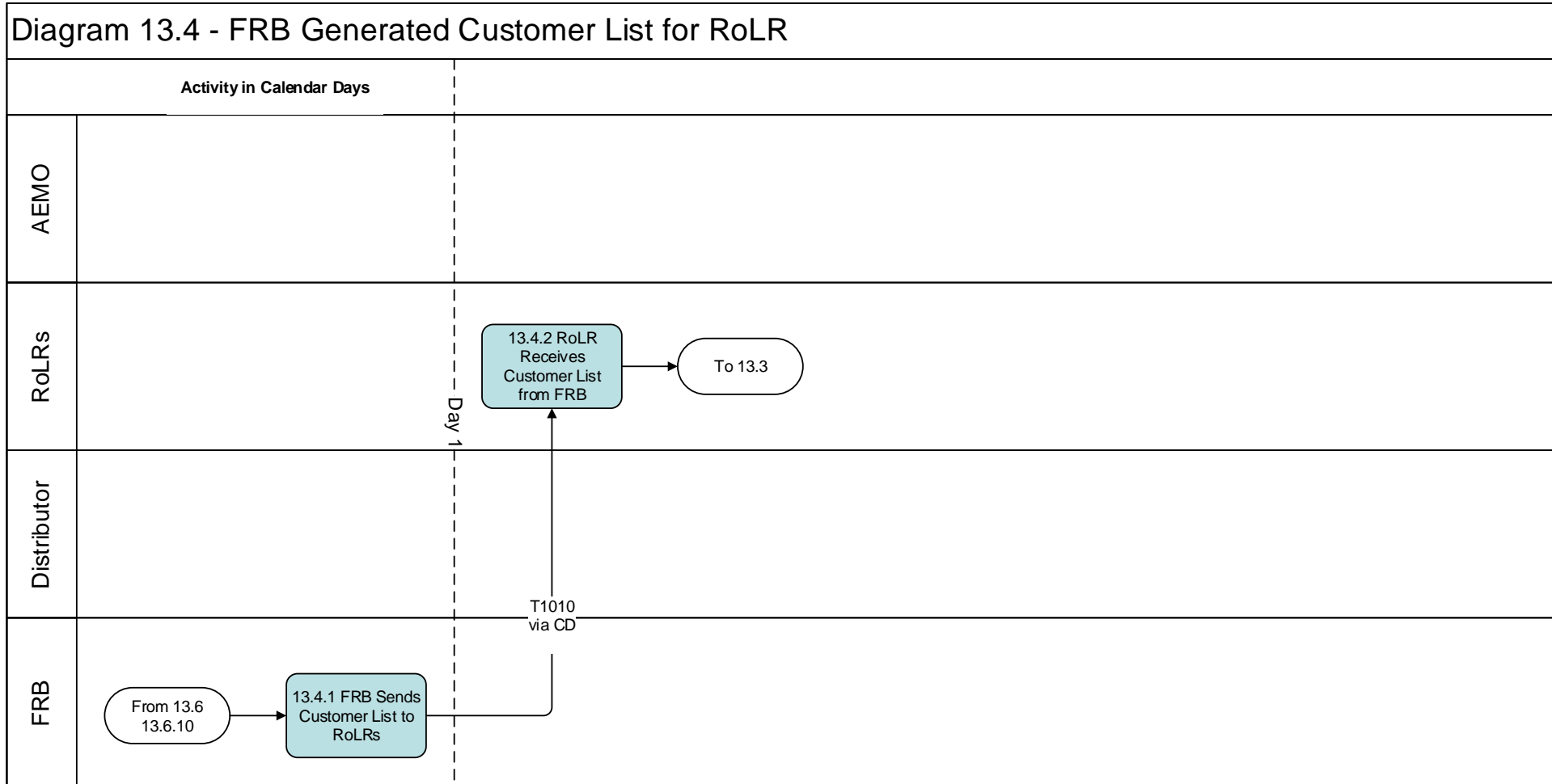



## 2.6 DIAGRAM 13.5 – WHOLESALE PROCESS

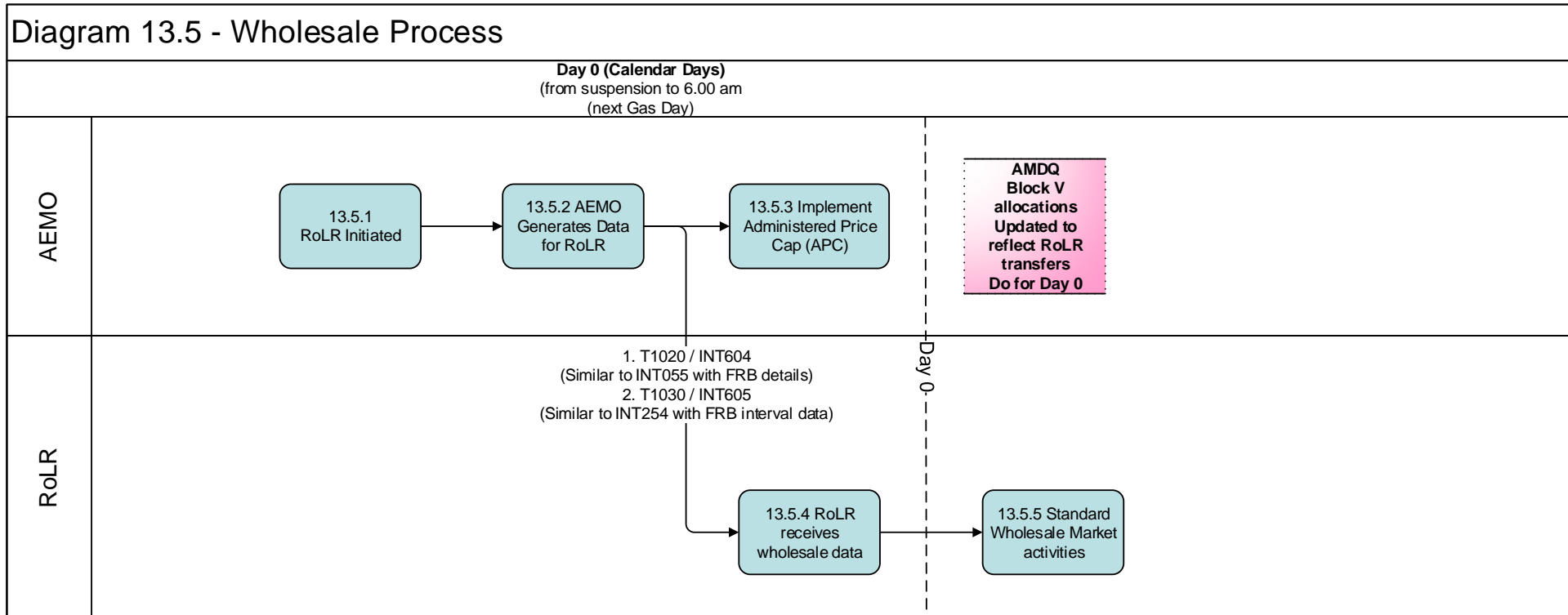

## 2.7 DIAGRAM 13.6 – ROLR COMMUNICATIONS

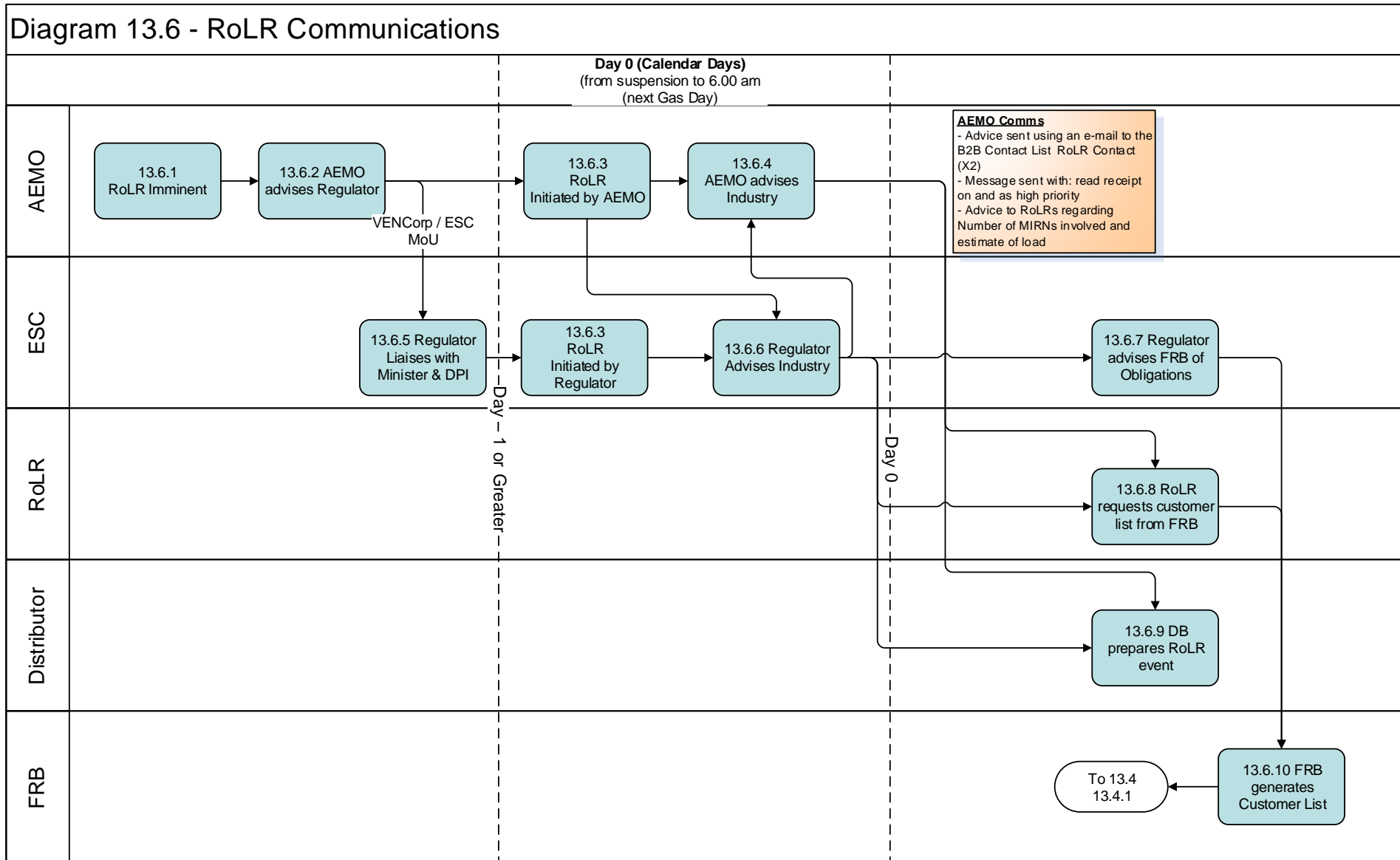

## 2.8 DIAGRAM 13.7 – PROVISION OF ESTIMATE TRANSFER READS AND SUBSEQUENT ADJUSTMENT

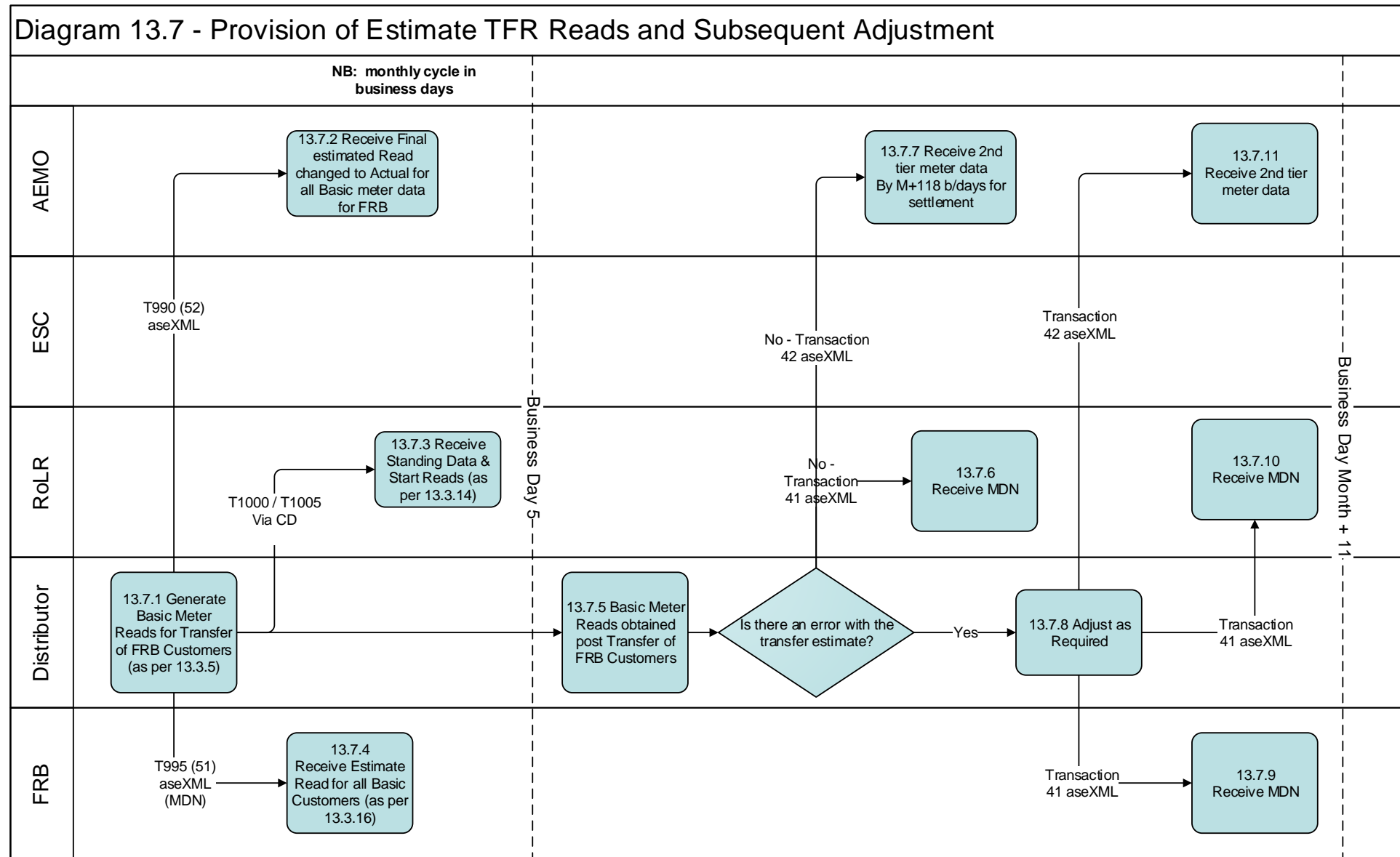

## 2.9 DIAGRAM 13.8 – SERVICE ORDERS IN FLIGHT

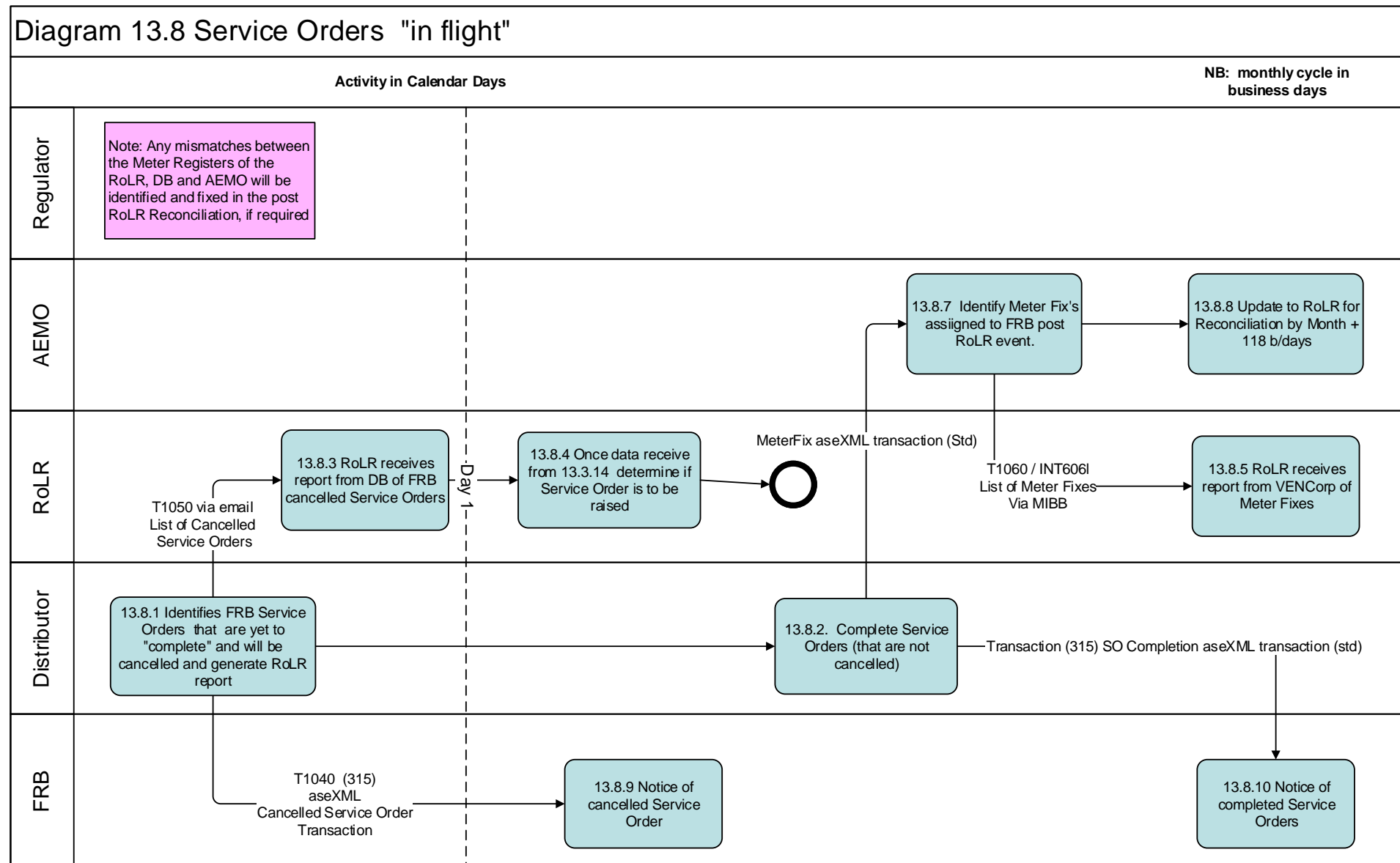

### 3 PROCESS FLOW DIAGRAMS

#### 3.1 DIAGRAM 99.1 – MAINS RENEWAL

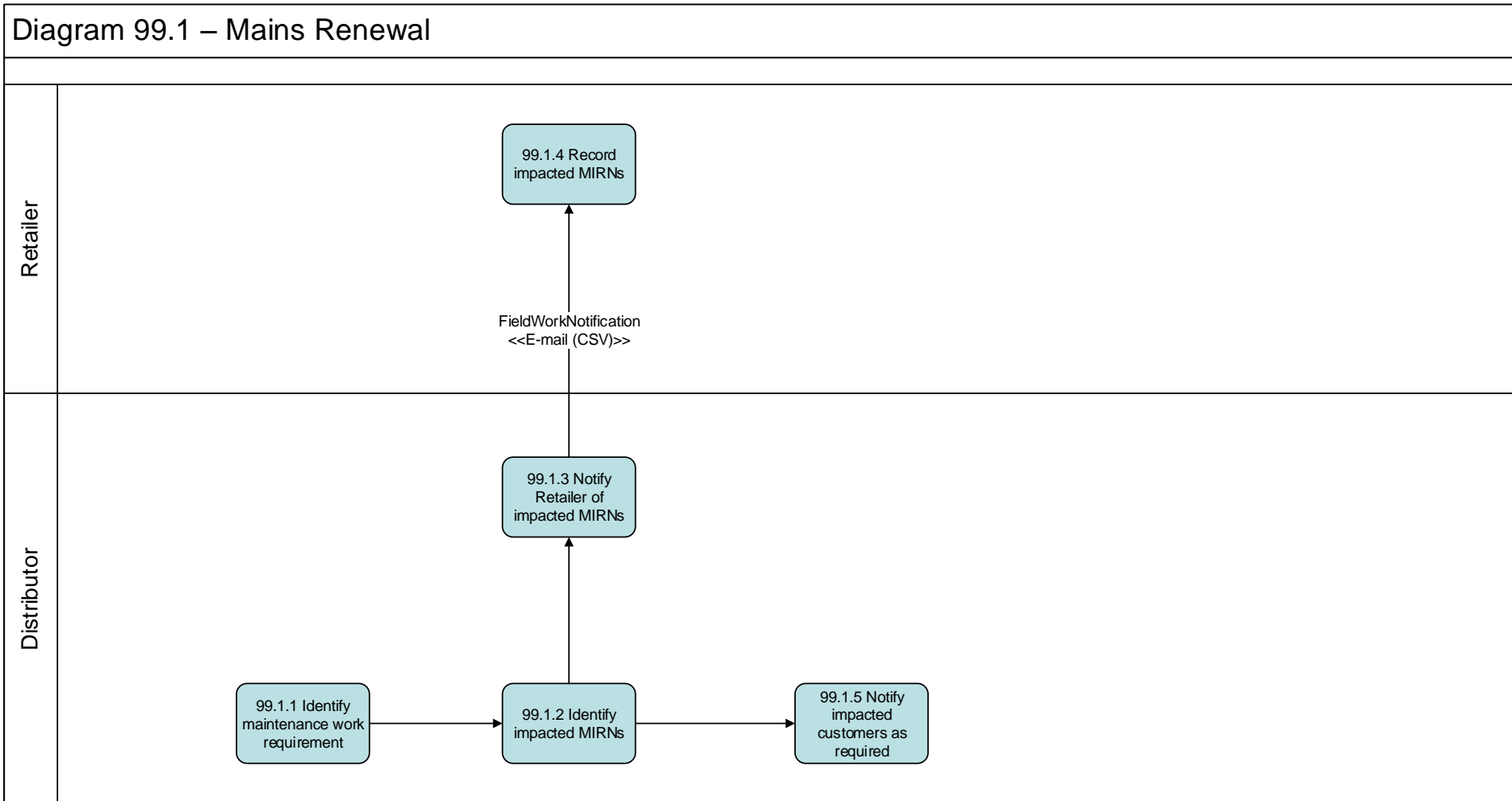

### 3.2 DIAGRAM 99.2 – NETWORK BILLING

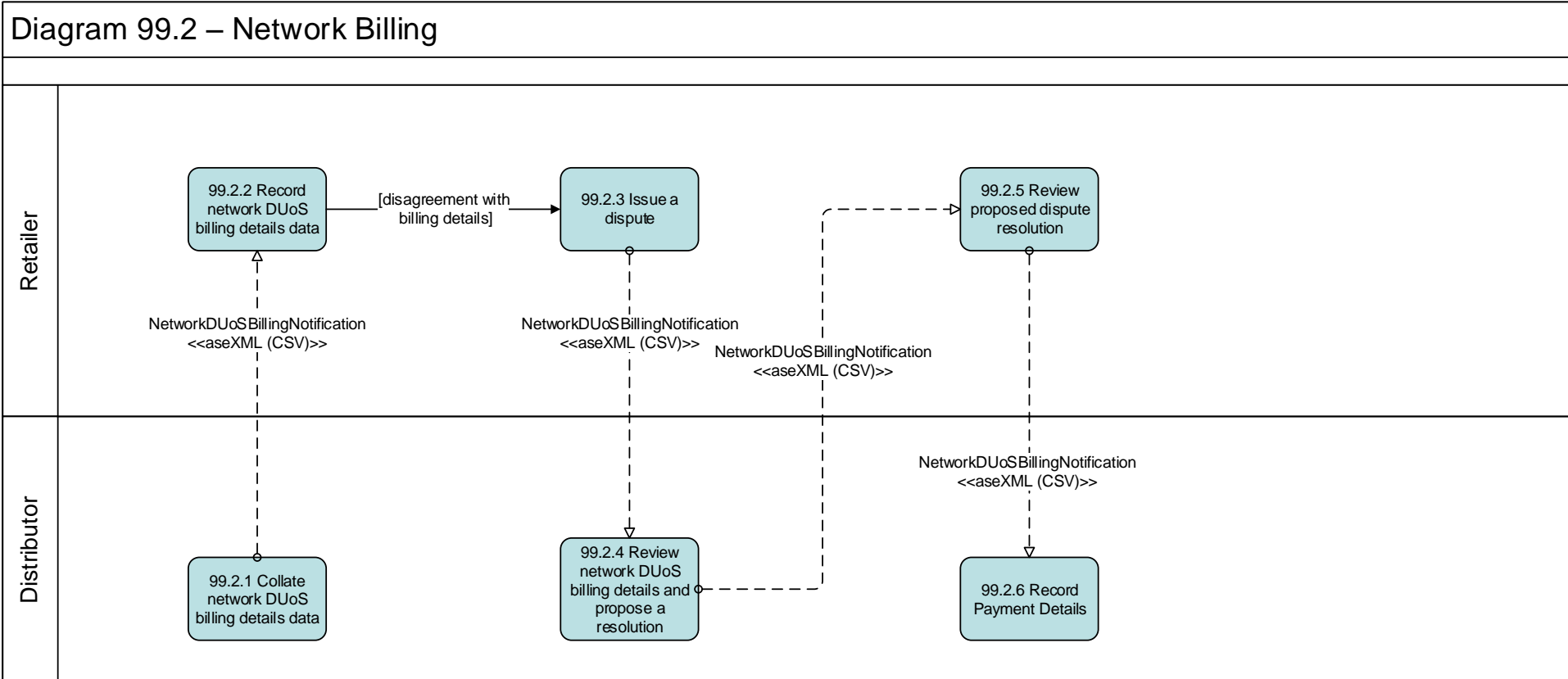

### 3.3 DIAGRAM 99.4 – MIRN STANDING DATA UPDATE

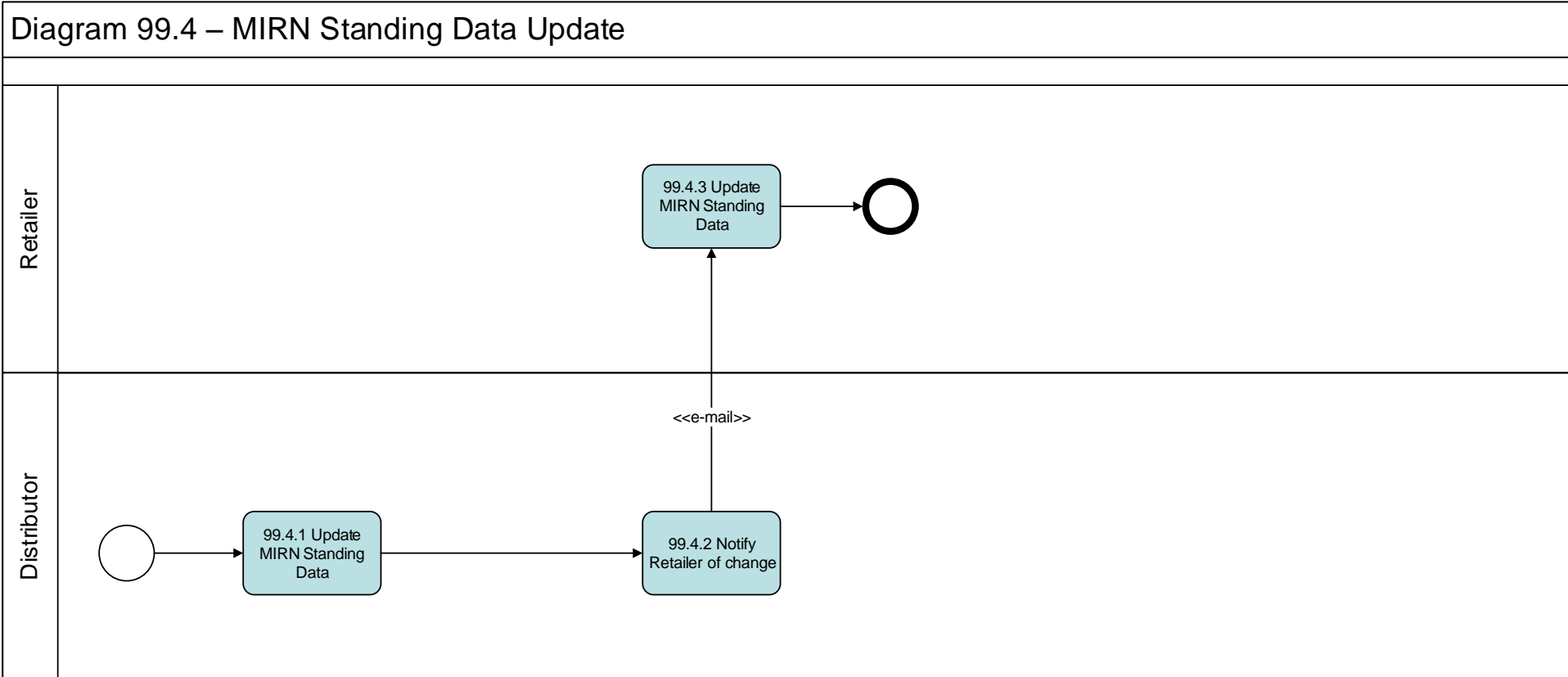

### 3.4 DIAGRAM 99.5 – METERED SUPPLY POINT COUNT UPDATE

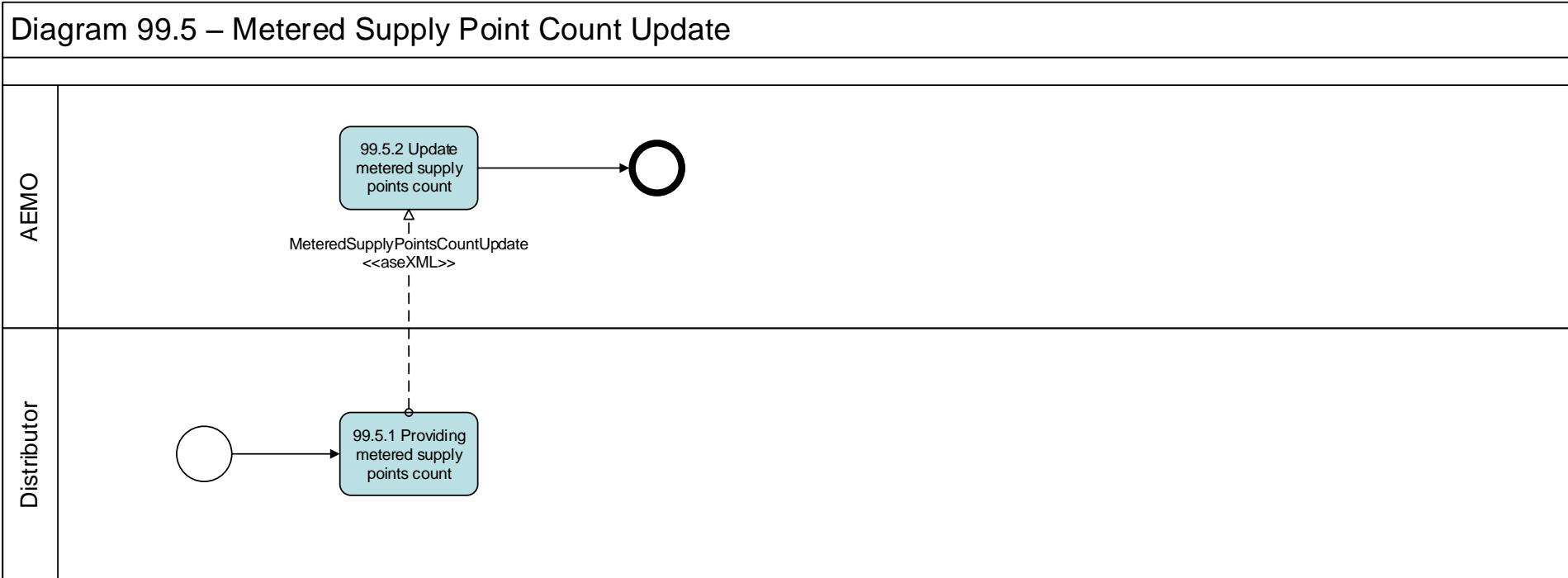



## 4 CUSTOMER CLASSIFICATION

### 4.1 DIAGRAM 99.9 – CUSTOMER REQUEST TO RETAILER

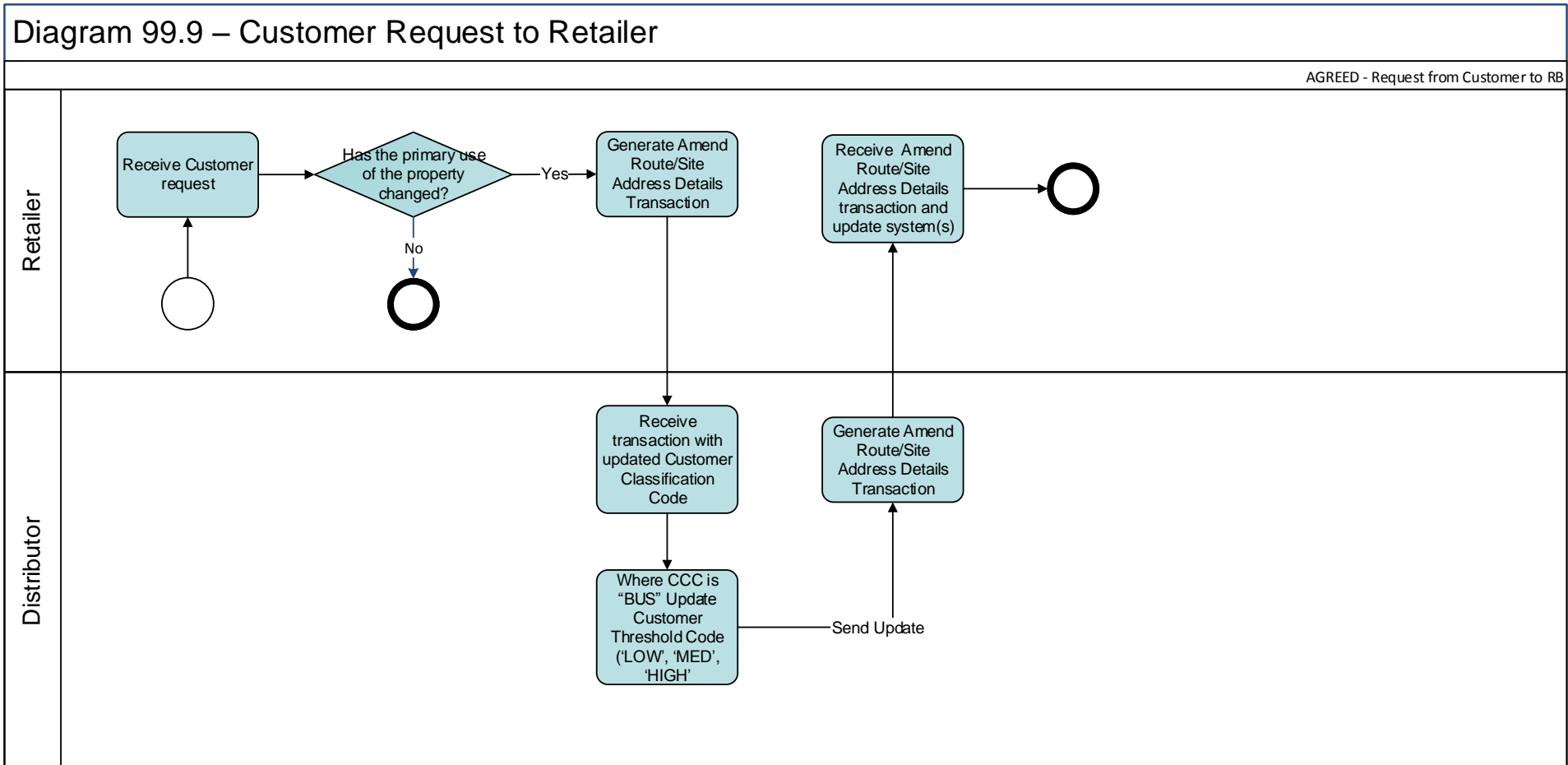

## 5 SERVICE ORDER PROCESS FLOWS

### 5.1 Diagram 100: Service Orders General (Simplified)

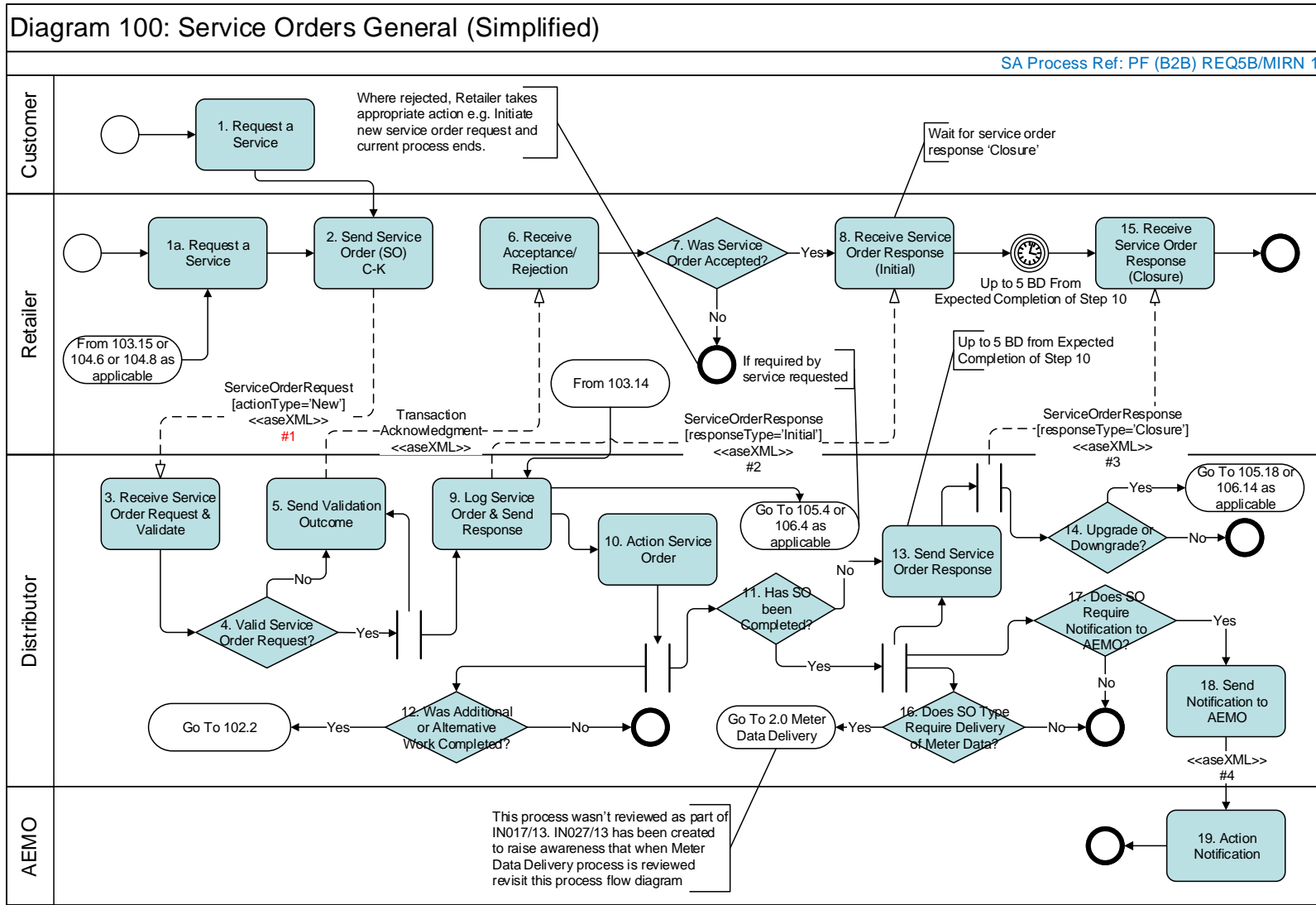

#1, 2, 3 & 4 Refer to Diagram 107 for the transactions involved

## 5.2 Diagram 101: Retailer Initiated Service Orders Cancellation

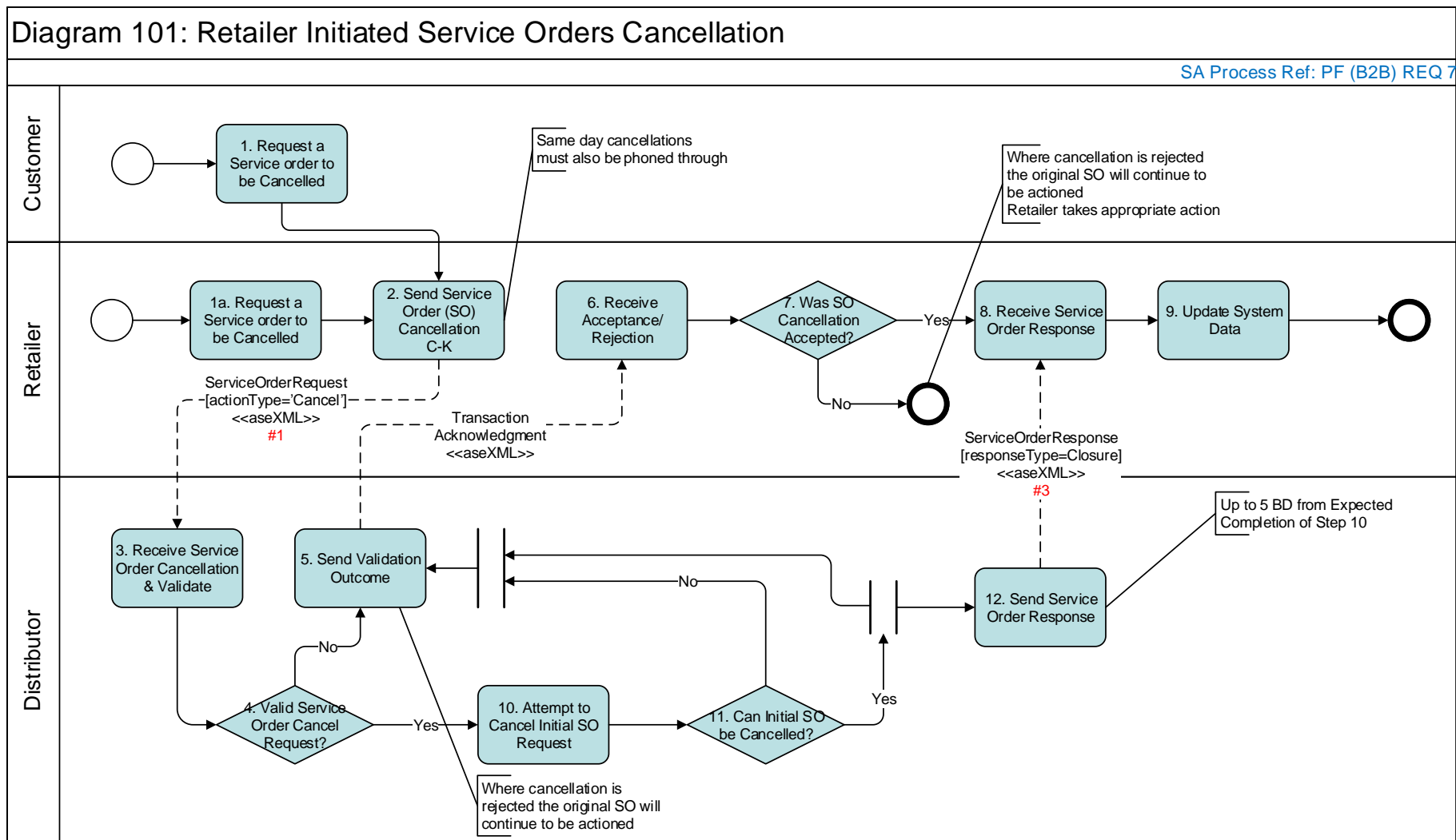

#1 & 3 Refer to Diagram 107 Table for the transactions involved

### 5.3 Diagram 102: Distributor Initiated Service Orders

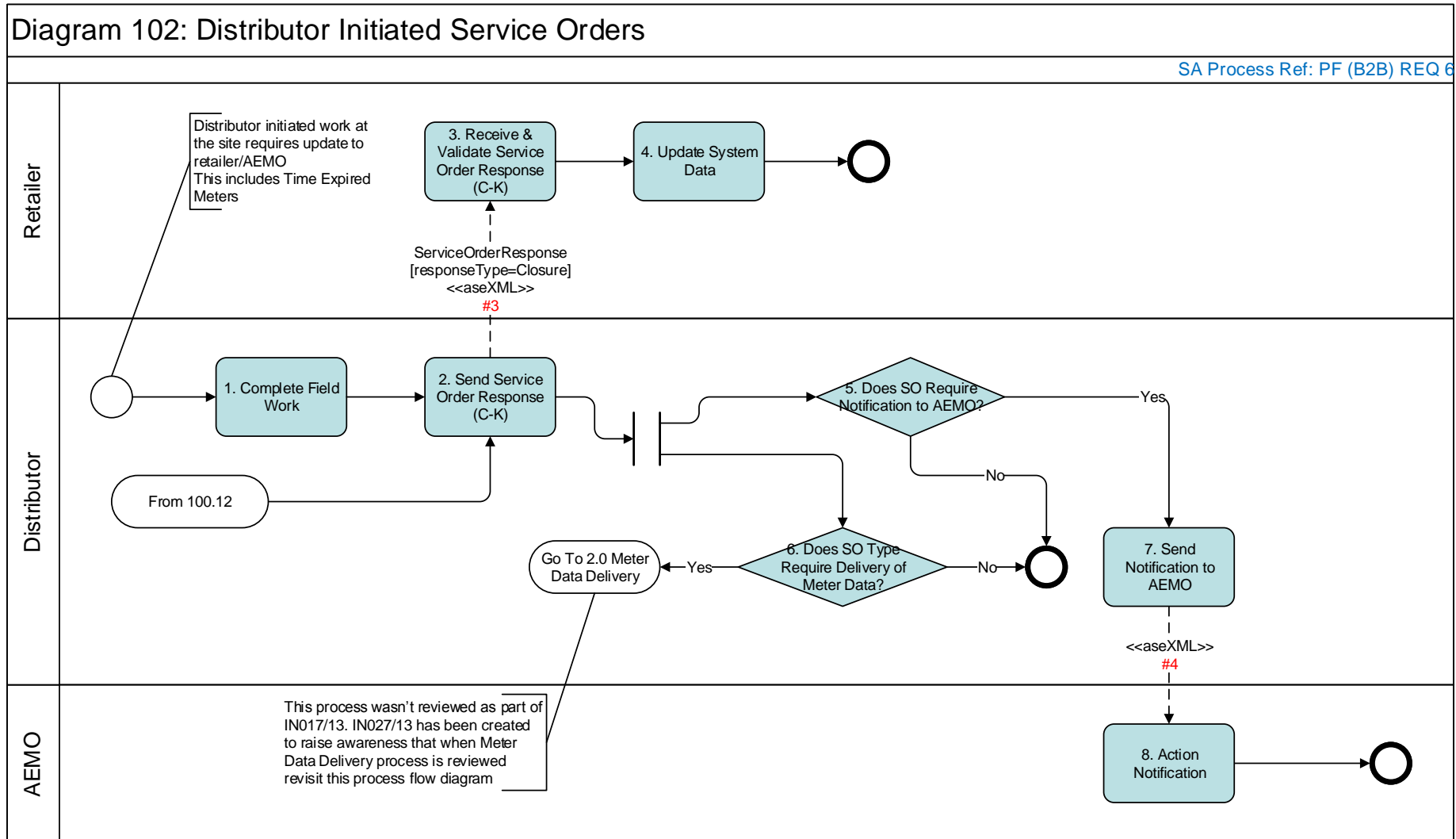

#3 & 4 Refer to Diagram 107 Table for the transactions involved

### 5.4 Diagram 103: Shipper Process

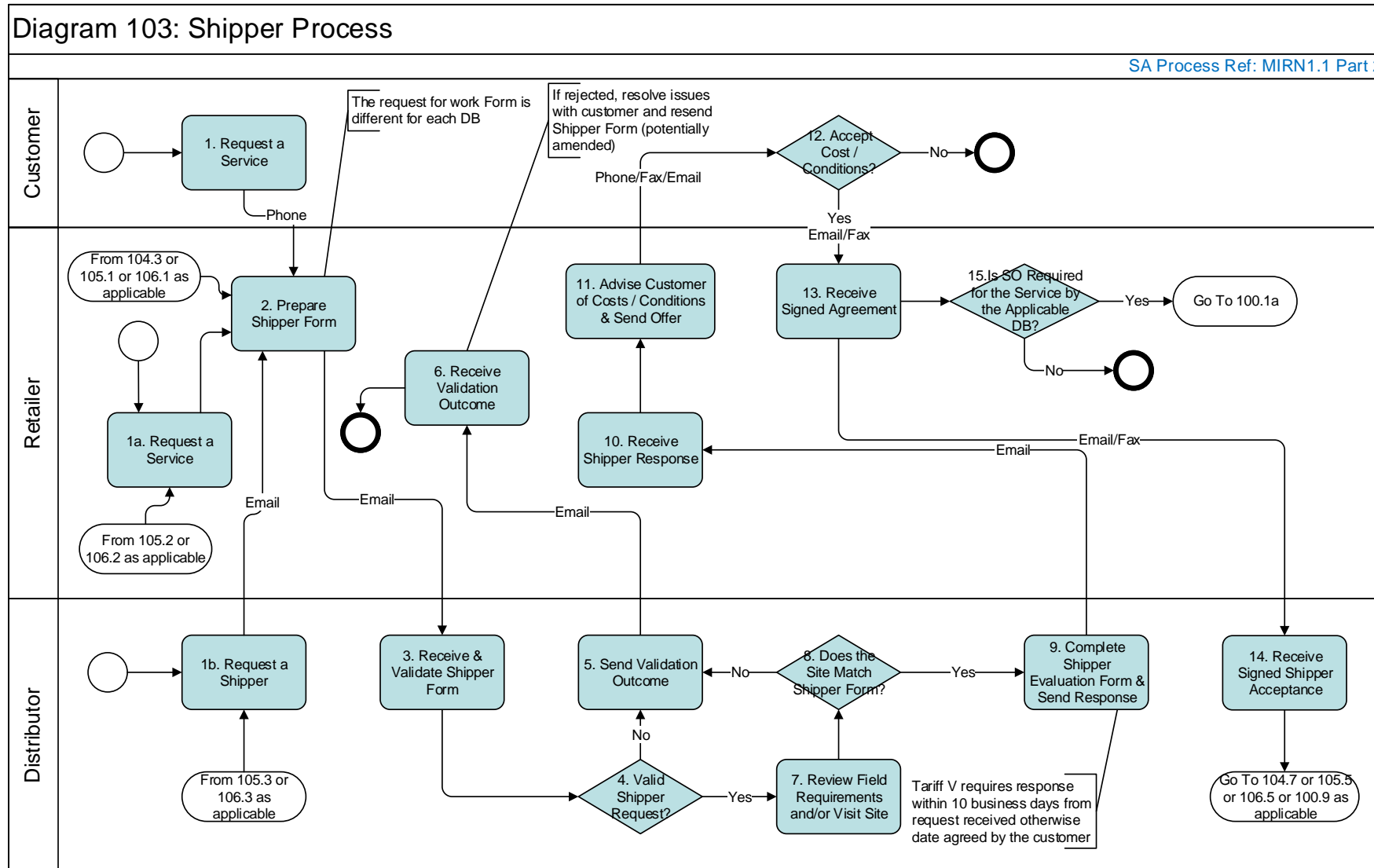

**Notes:** Service Order Enquiry Code  
 MAP, MFX, MRT, RSR, SCR, UMS,  
 USR

### 5.5 Diagram 104: Meter Fix Request

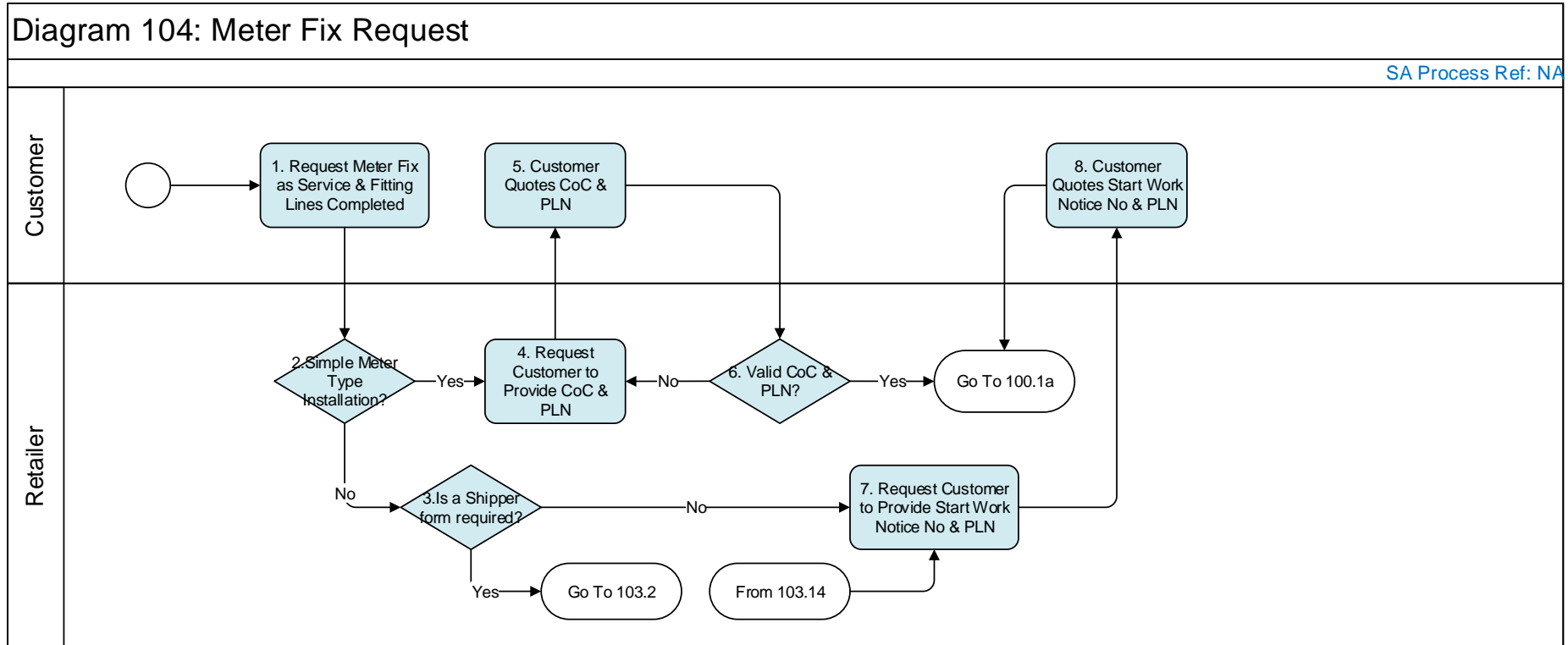

### 5.6 Diagram 105: Upgrade from Basic to Interval Meter

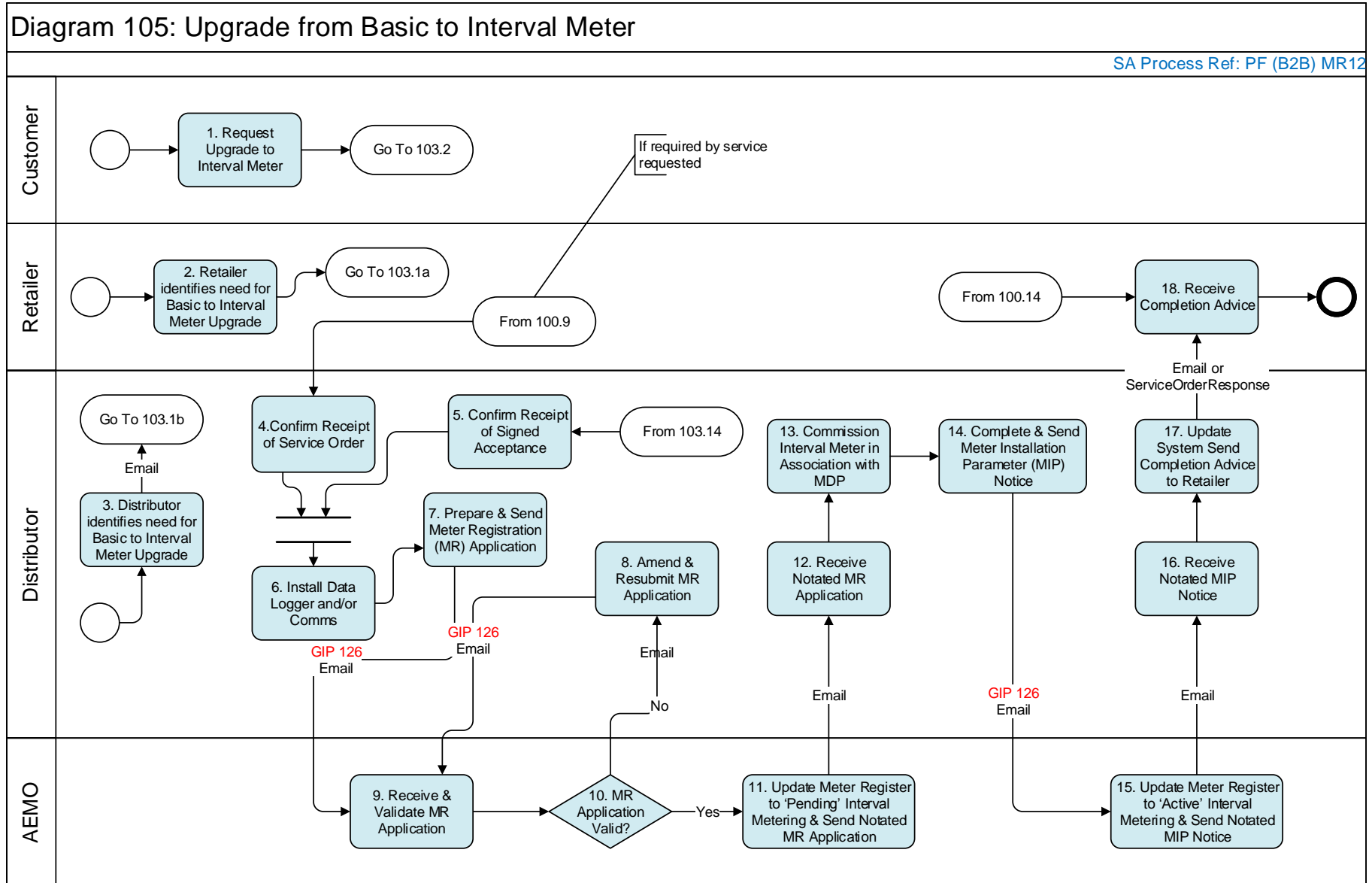

### 5.7 Diagram 106 : Downgrade from Interval to Basic Meter For tariff D

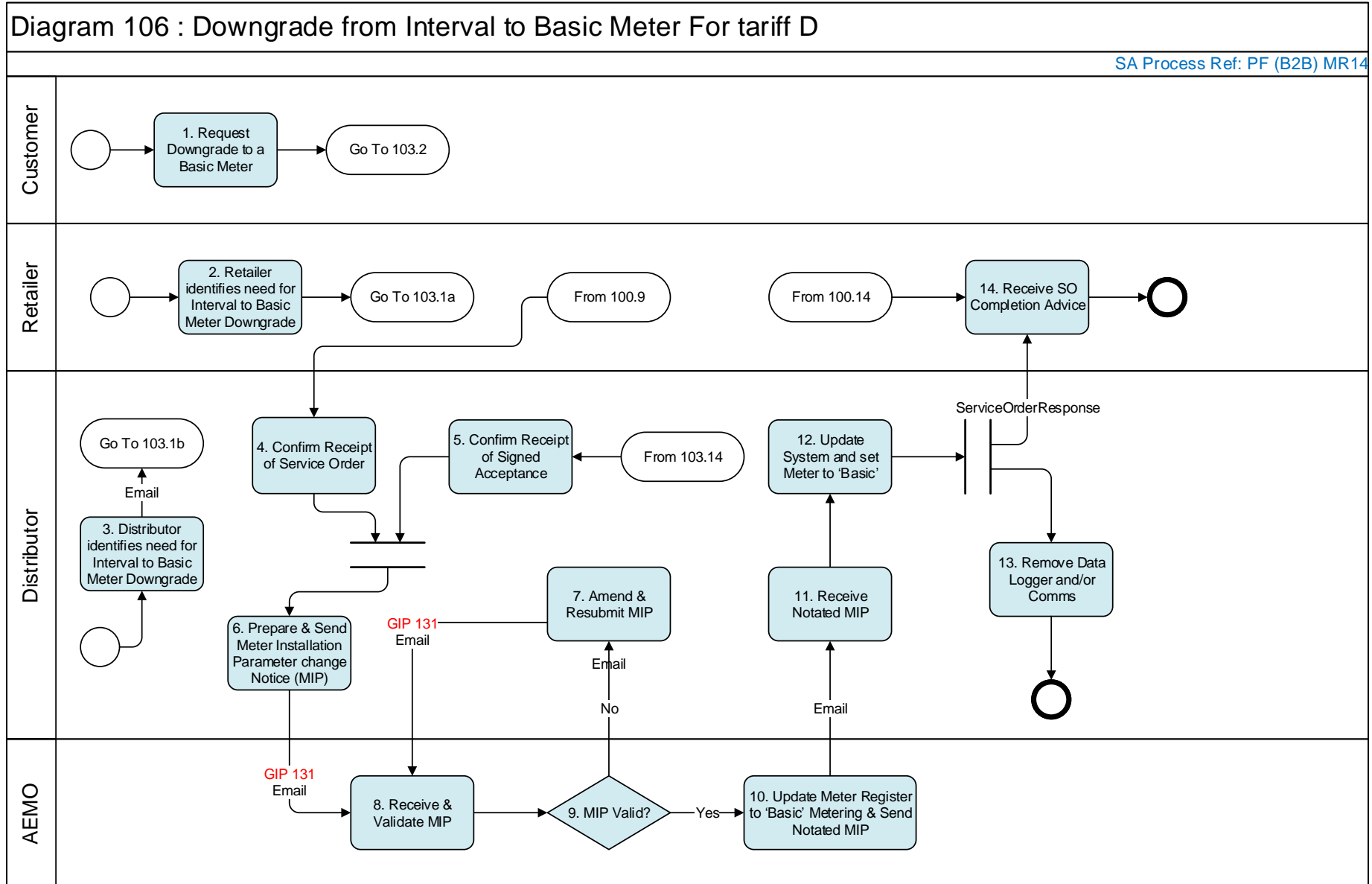



## 5.8 Diagram 107: Service Order Transaction Table

Diagram 107: Service Order Transaction Table

#1 Service Orders Request C-K	#2 Service Order Response C-K (Initial)	#3 Service Order Response C-K (Final)	#4 Status Change Response
GIP 87 - Meter Fix Request (JEC = MFX)	GIP 87A - Meter Fix Request Response	GIP 92 - Meter Fix Completed	GIP 94 - Meter Fix Notification
		GIP 93 - No Access to Complete Meter Fix	
GIP 101 - Meter Change Request (JEC = MCH)	GIP 101A - Meter Change Request Response	GIP 104 - No Access to Complete Meter Change	
		GIP 108 - Meter Change Completed	
		GIP 125 - Meter Upgrade Completed	
GIP 151 - Meter Removal Request (JEC = MRM)	GIP 151A - Meter Removal Request Response	GIP 154 - No Access to Complete Meter Removal	GIP 158 - MIRN Status Update Notification
		GIP 157 - Meter Removal Completed	
GIP 310 - Service Connection Request (JEC = SCR)	GIP 310A - Service Connection Request Response	GIP 311 - Service Connection Complete	
GIP 312 - Service Disconnection Request (JEC = SDR)	GIP 312A - Service Disconnection Request Response	GIP 313 - Service Disconnection Complete	GIP 158 - MIRN Status Update Notification
GIP 314 - Service Orders for Priority C-K (JEC = All JEC's)	GIP 314A - Service Orders for Priority C-K Response	GIP 315 - Service Orders Completed for Priority A-K	
GIP 316 - Relocate Service Request (JEC = RSR)	GIP 316A - Relocate Service Request Response	GIP 317 - Relocate Service Complete	
GIP 318 - Upgrade Service Size Request (JEC = USR)	GIP 318A - Upgrade Service Size Request Response	GIP 319 - Upgrade Service Size Complete	
GIP 320 - Upgrade Meter Size Request (JEC = UMS)	GIP 320A - Upgrade Meter Size Request Response	GIP 321 - Upgrade Meter Size Complete	

JEC = Job Enquiry