



Victorian Annual Planning Report

October 2021

Published by AEMO under its declared network
functions in Victoria

Important notice

PURPOSE

The purpose of this publication is to provide information relating to electricity supply, demand, network capability, and development for Victoria's electricity transmission declared shared network.

AEMO publishes the Victorian Annual Planning Report (VAPR) under its declared network functions in Victoria, and in accordance with clause 5.12 of the National Electricity Rules. This publication is generally based on information available to AEMO as at June 2021, although AEMO has incorporated more recent information where practical.

DISCLAIMER

AEMO has made every reasonable effort to ensure the quality of the information in this publication, but cannot guarantee that information, forecasts, and assumptions are accurate, complete or appropriate for your circumstances. This publication does not include all the information that an investor, participant, or potential participant in the National Electricity Market might require and does not amount to a recommendation of any investment.

Anyone proposing to use the information in this publication (which includes information and forecasts from third parties) should independently verify its accuracy, completeness and suitability for purpose, and obtain independent and specific advice from appropriate experts.

Accordingly, to the maximum extent permitted by law, AEMO and its officers, employees and consultants involved in the preparation of this publication:

- make no representation or warranty, express or implied, as to the currency, accuracy, reliability or completeness of the information in this publication; and
- are not liable (whether by reason of negligence or otherwise) for any statements, opinions, information or other matters contained in or derived from this publication, or any omissions from it, or in respect of a person's use of the information in this publication.

VERSION CONTROL

Version	Release date	Changes
1	29/10/2021	Initial release

Executive summary

Under its declared network functions, including for Victorian transmission planning, set out in the National Electricity Law (NEL), Australian Energy Market Operator (AEMO) is responsible for planning and directing augmentation on the Victorian electricity transmission Declared Shared Network (DSN). AEMO works closely with stakeholders, including other network service providers (NSPs), industry stakeholders, consumers representatives, and other interested parties, to develop a power system in the most cost-effective way for the benefit of consumers.

Fast facts about the Victorian Declared Shared Network

- The network connects large-scale generation (including wind, solar, hydro, gas, and coal power plants) to large directly connected industrial customers and the distribution networks that deliver electricity to homes and businesses.
- Annual peak demand of 8.4 gigawatts (GW) occurred on 11 January 2021.
- All-time minimum demand record of 2.5 GW occurred on the afternoon of 25 December 2020.
- Installed large-scale generation capacity is 12.9 GW and distributed generation capacity (installed behind the meter by households and businesses) is 3.1 GW.
- Since publication of the 2020 VAPR, 472 megawatts (MW) of large-scale renewable generation connected (finished commissioning) in Victoria, and 733 MW commenced commissioning.
- AEMO's *Transmission Development Plan for Victoria* proposes targeted investment to adapt to rapid changes in the Australian energy landscape.
- Visit AEMO's interactive maps for further information about the Victorian DSN¹.

Like many other power systems around the world, Australia's electricity industry is rapidly transforming; Victoria is at the forefront of this transformation. This is being driven by strong investment in large-scale renewable generation and the rapid rise of distributed photovoltaic (PV) installations on homes and businesses across the state. New technologies and changing human behaviour are also having a significant influence on this change. Targeted investment in transmission infrastructure is critical to adapt to these changes and harness Victoria's rich energy resources in a cost-effective manner to deliver benefits to consumers across Victoria and the National Energy Market (NEM).

The VAPR builds on the national plan developed through AEMO's *Integrated System Plan* (ISP) and provides local insights relating to:

- The performance of the Victorian DSN over the past year.
- The **adequacy of the network to meet reliability and security** needs over the coming 10 years and adapt to the rapid transformation to a renewable energy power system.
- Emerging network limitations, potential solutions to alleviate them, and **AEMO's *Transmission Development Plan for Victoria*** to deliver lower-cost outcomes for consumers under the current regulatory framework.
- Challenges and opportunities emerging in the transition to a renewable power system, to **support stakeholders to make informed investment decisions** in Victoria.

¹ At <https://www.aemo.com.au/aemo/apps/visualisations/map.html>.

Key insights from the 2021 VAPR

The Victorian DSN remained secure in 2020-21, despite record low minimum demand and unprecedented levels of inverter-based renewable (IBR) generation

- Milder weather conditions over the 2020-21 summer period led to a 13% reduction in maximum operational demand, from 9,667 MW in 2019-20 to 8,411 MW on 11 January 2021. No Reliability and Reserve Trader (RERT) contracts were activated in Victoria in 2020-21.
- A record minimum demand of 2,529 MW occurred on 25 December 2020. This was 688 MW lower than the previous record, set in 2017-18. Low minimum demands continued to drive a need for operational interventions (such as de-energising 500 kilovolt [kV] lines and utilising Non-Market Ancillary Services [NMAS]) to manage high voltages on the network. However, transmission investments in reactive power plant are reducing the need for intervention.
- Network limitations in the west and north-west of Victoria continue to present challenges as large volumes of IBR generation continue to connect. Generator restrictions have been needed to manage system security during high renewable generation periods, and outages have been accommodated to connect new projects. While minor augmentations on the transmission network, and system strength services, are reducing these constraints, further investment is required to unlock renewable generation in the western regions of the state.
- There were five reviewable power incidents in 2020-21 which resulted in loss of loads or generation.

Rapid changes in the technical characteristics and geography of supply will present future network limitations which require targeted investment

- The Victorian energy landscape continues to transform, driven by continued development of large-scale renewable generation in regional areas, ongoing aggressive uptake by consumers of distributed energy resources (DER), and the withdrawal of synchronous generation.
- Of the 18.3 GW of existing and committed generation capacity in Victoria, approximately 8.2 GW (45%) is from wind and solar generation. This includes 3.1 GW of distributed PV.
- In the last year, 472 MW of large-scale renewable generator projects connected (finished commissioning) in Victoria, and a further 733 MW commenced commissioning. A further 503 MW of renewable projects committed to connect.
- Victoria currently has 375 MW of existing or committed battery storage, including Victoria's Big Battery, a 300 MW battery storage project which is expected to be in service by the end of 2021.
- The Victorian Government's Victorian Renewable Energy Target (VRET), to deliver 40% renewable energy generation by 2025 and 50% by 2030², is expected to require up to 5.0 GW of additional renewable generation in Victoria. This is projected to be delivered through a combination of DER and large-scale renewable projects (see Section 3.2). *AEMO's Transmission Development Plan for Victoria* will enable this target to be met.
- Figure 1 shows large-scale generation and storage capacity that is currently operating, committed, or proposed in Victoria³.

² See <https://www.energy.vic.gov.au/renewable-energy/victorias-renewable-energy-targets>.

³ From AEMO, Generation Information webpage, Victoria update October 2021, at <http://www.aemo.com.au/Electricity/National-Electricity-Market-NEM/Planning-and-forecasting/Generation-information>.

Figure 1 Current, committed, and proposed large-scale generation and storage in Victoria

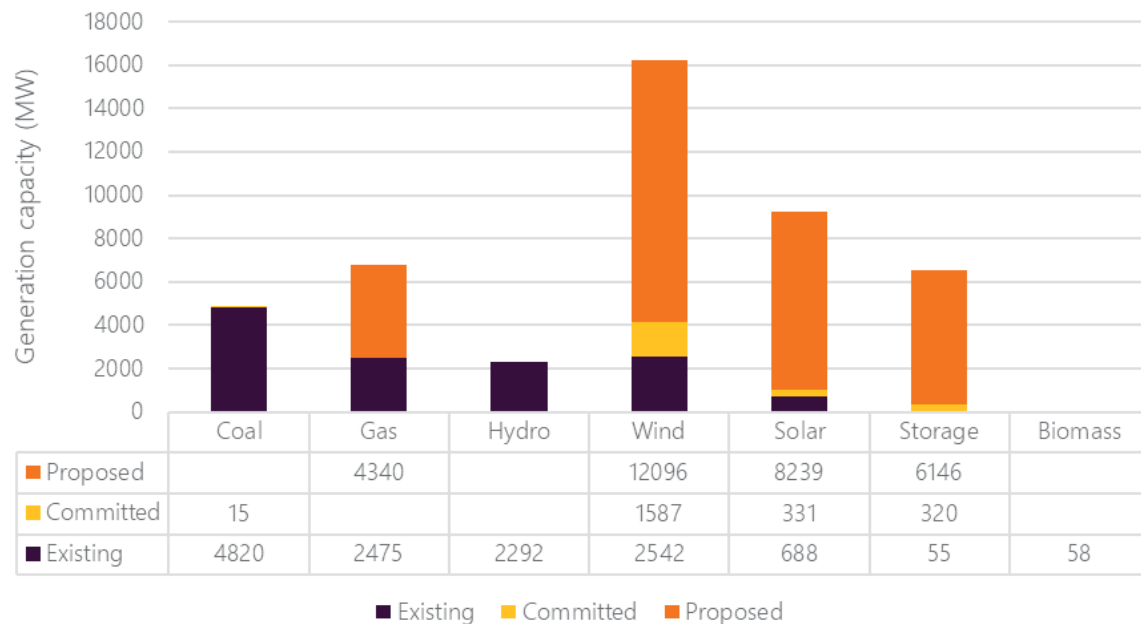

- The retirement of Yallourn Power Station in 2028 will withdraw almost 1.5 GW of generation capacity, and shift power flow dynamics on the Victorian DSN. Asset utilisation in the Latrobe Valley is sensitive to how the network is configured and generation dispatch. Therefore, AEMO has identified potential limitations on the network between Melbourne and the Latrobe Valley, which may require changes to how the network is configured following Yallourn retirement.
- The withdrawal of Yallourn also raises a potential 390 MW reliability gap in Victoria in 2030-31, as reported in AEMO’s 2021 *Electricity Statement of Opportunities* (ESOO) for the NEM⁴. While the ESOO assessment only considers existing and committed projects, multiple developments are expected to fill this gap, including 26.5 GW of additional proposed renewable generation projects (wind, solar and storage), the 350 MW, four-hour, large-scale Jeeralang Battery, and proposed transmission network investments, such as Victoria – New South Wales Interconnector (VNI) West and Marinus Link.

AEMO’s Transmission Development Plan for Victoria

- Targeted and timely investment in transmission infrastructure is required to provide consumers with the most cost-effective energy outcomes that leverage the geographic diversity of renewable resources, while adapting to the newly emerging technical characteristics of the power system.
- AEMO is progressing a suite of projects across the state through its *Transmission Development Plan for Victoria*, which is set out in this report. This plan builds on the ISP and is designed to deliver security, and reliability objectives in the context of Victorian Government policy and regulatory settings. Together these investments target key thermal, stability, voltage control, and system strength limitations across Victoria. They will act to reduce overall costs to consumers by unlocking lower-cost generation supplies, enhancing competition, and improving the efficiency of resource sharing between neighbouring NEM regions.

Delivered and committed projects

These projects (see Figure 2) are:

- Renewable energy zone (REZ) expansion, Western Victoria and Murray River:

⁴ At <https://aemo.com.au/en/energy-systems/electricity/national-electricity-market-nem/nem-forecasting-and-planning/forecasting-and-reliability/nem-electricity-statement-of-opportunities-esoo>.

- Following completion of the Western Victoria Regulatory Investment Test for Transmission (RIT-T) in July 2019, an appropriately and sensitively designed, located and constructed Western Victoria Transmission Network Project is expected to be delivered by AusNet Services by 2025 to unlock renewables resources in the Western Victoria REZ.
- The associated minor augmentations in west and north-west Victoria were delivered in 2021 through AusNet Services' Network Capability Incentive Project Action Plan (NCIPAP).
- Modifications are being made to the Murraylink Very Fast Runback Scheme to adapt to changes in network conditions in the west and north-west of Victoria.
- Interconnection:
 - At the request of the Victorian Government, AEMO has procured a system integrity protection scheme (SIPS) that will increase VNI import capabilities by up to 250 MW from November to March each year. The scheme is expected to be in service by the end of 2021.
 - Following completion of the VNI Upgrade RIT-T, AEMO and TransGrid are jointly delivering an upgrade to increase VNI export capability by up to 170 MW by 2022-23.
 - TransGrid and ElectraNet are progressing the delivery of Project EnergyConnect, a new interconnector between South Australia and New South Wales via Red Cliffs in north-west Victoria. The project is expected to be completed by late 2024.
 - Series compensation equipment was installed on the Wodonga – Jindera 330 kV line to allow a minor increase in VNI flow through AusNet Services' NCIPAP in June 2021.
- Voltage control – following completion of the Victorian Reactive Power Support RIT-T, three new reactors are being delivered to maintain network voltages during low demand conditions. This project is in addition to the reactor delivered at Keilor in 2021 under AusNet Services' NCIPAP.
- System strength – AEMO has entered into short-term agreements to remediate the system strength shortfall at Red Cliffs until 2022. A procurement process is ongoing for a longer-term solution.

Figure 2 Transmission Development Plan for Victoria – delivered and committed projects

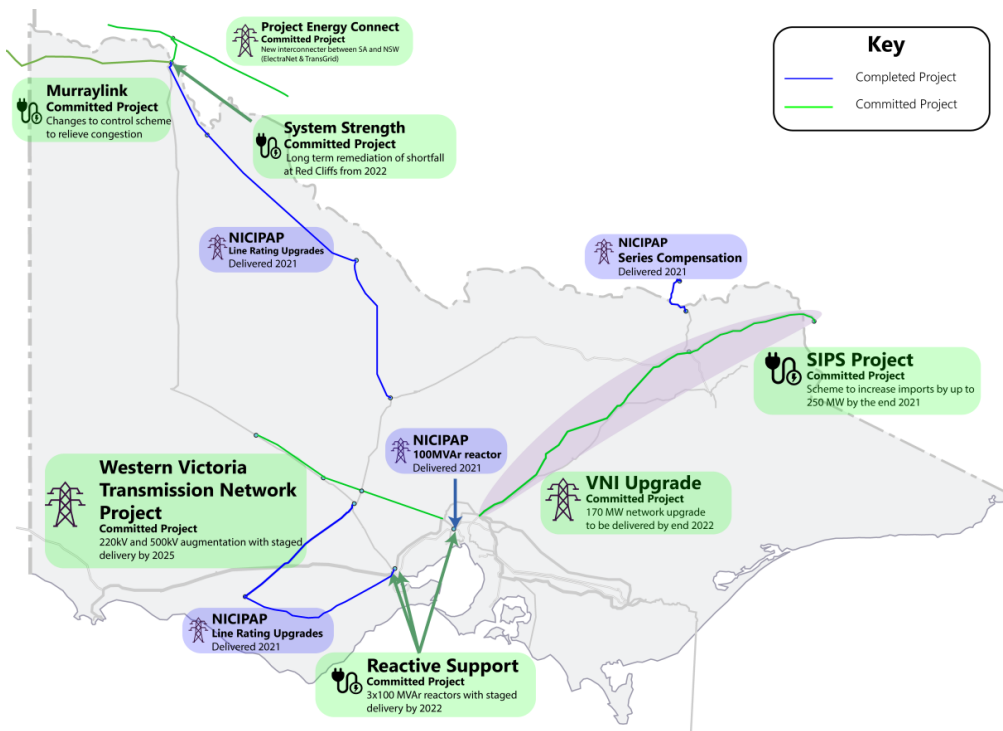

Note: Paths in map are indicative only.

Figure 3 summarises the capacity of wind and solar projects in each REZ, and the available hosting capacity when committed transmission investments are delivered⁵.

Figure 3 Summary of Victorian REZs

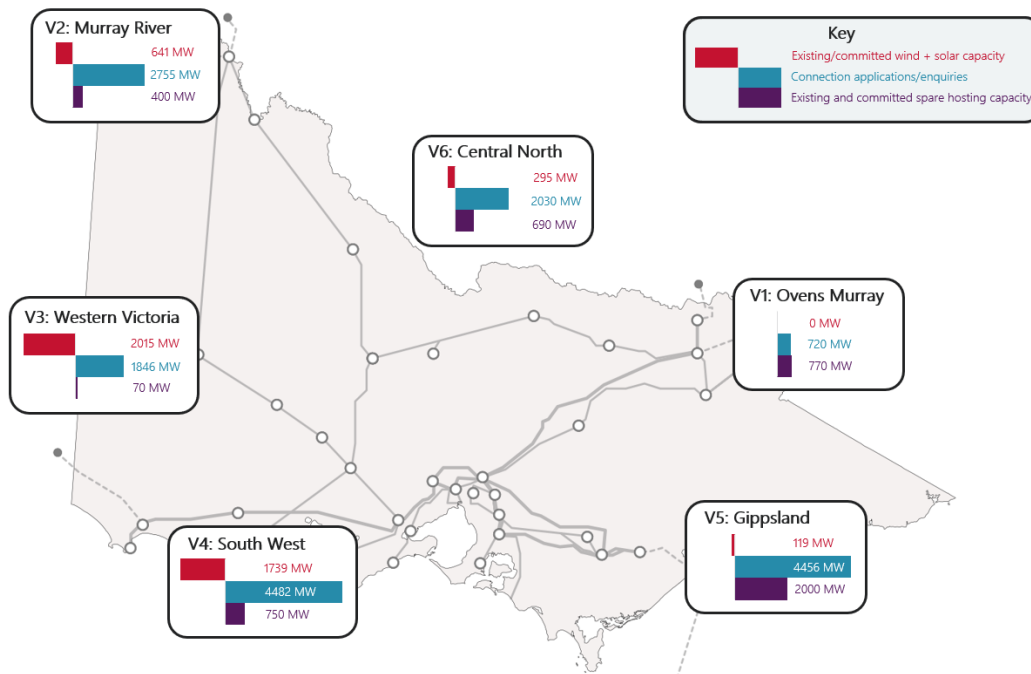

The following future projects are being progressed or investigated to deliver additional capacity across the state

Future projects

These projects (see Figure 3) are:

- Interconnection and REZ expansion – AEMO and TransGrid are jointly progressing the VNI West RIT-T, to deliver additional transfer capacity between Victoria and New South Wales. This project aims to improve supply reliability, yield more efficient development and dispatch of high-quality renewable resources, and allow more efficient sharing of resources between NEM regions.
- Interconnection – TasNetworks has published a Project Assessment Conclusions Report (PACR)⁶ to deliver Marinus Link, a new 1,500 MW high voltage direct current (HVDC) cable between Tasmania and Victoria, and associated works.

Priority limitations

AEMO has identified priority limitations (see Figure 3) for which credible solutions may deliver positive net market benefits in the next 10 years and are being considered as potential future projects. They are:

- Voltage control – high voltages in Metropolitan Melbourne and South West Victoria caused by low and negative demand conditions are forecast in the 2021 ESOO over the next decade. AEMO intends to begin a RIT-T in 2022, subject to the outcome of pre-feasibility assessments currently underway.
- REZ expansion:

⁵ Existing hosting capacity values are based on the 2020 ISP and 2021 Transmission Cost Report, and have been updated to include newly committed generators. Applications and enquiries as at September 2021 from AEMO’s Victoria connections map: <https://aemo.com.au/energy-systems/electricity/national-electricity-market-nem/participate-in-the-market/network-connections/nem-generation-maps>.

⁶ See <https://www.marinuslink.com.au/wp-content/uploads/2021/06/Project-Marinus-RIT-T-PACR.pdf>.

- Overloading of the Ballarat – Berrybank – Terang – Moorabool 220 kV line for a trip of the Moorabool – Terang line, due to new connections.
- Overloading of the Bulgana – Horsham – Murra Warra 220 kV line for trip of the Bendigo – Kerang line, due to new connections between Horsham and Kerang.
- Overloading of the Red Cliffs – Wemen – Kerang – Bendigo 220 kV line for a trip of the Horsham – Murra Warra – Kiamal 220 kV line, due to new connections between Kiamal and Kerang.
- Voltage instability/collapse around Wemen Terminal Station for trip of the Horsham – Murra Warra – Kiamal 220 kV line, due to new connections between Kiamal and Wemen.

Figure 4 Transmission Development Plan for Victoria – future projects and priority limitations

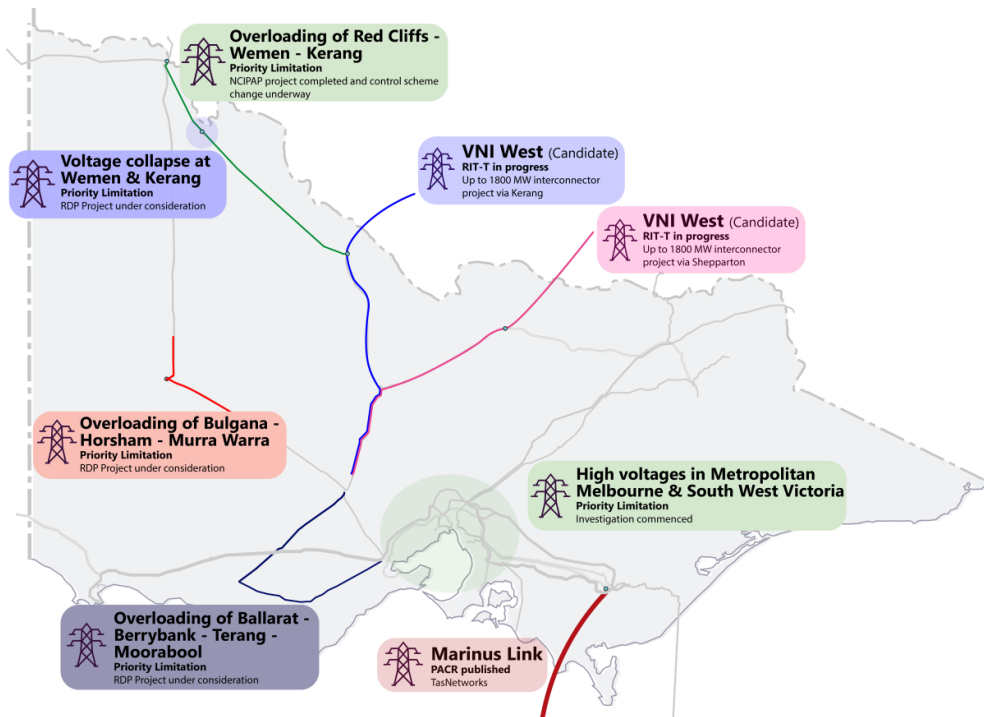

Note: Paths in map are indicative only.

REZ Development Plan (RDP) projects

AEMO is working with the Victorian Government to support its plans to outline network investments that enable further renewable development in Victorian REZs. By Ministerial Order under the *National Electricity (Victoria) Act 2005*⁷ (NEVA), the Victoria Government has directed AEMO to progress procurement activities for six potential near-term projects (Stage 1). If these projects proceed, some priority limitations may be improved, as noted in Figure 4. Section 6.4.1 describes all RDP projects being progressed and considered further.

Beyond the development plan

AEMO's *Transmission Development Plan for Victoria* set outs projects that are expected to relieve network limitations and deliver net market benefits under the current regulatory framework, which assumes new generation develops in optimal locations on the network. Locational signals such as network constraints, marginal loss factors (MLFs), and system strength levels are used in the NEM to inform and incentivise third parties (including governments) to invest in areas of the network that are likely to provide most value to electricity consumers.

⁷ See <http://www.gazette.vic.gov.au/gazette/Gazettes2021/GG2021S417.pdf>.

However, renewable development interest continues to outpace connection capacity in weak network locations, where high-quality solar and wind resources are abundant. As these parts of the network were not originally designed to support such high connection density, investors continue to face economic and technical challenges associated with connection to these weaker parts of the grid.

Any investment in transmission infrastructure needs to carefully balance the needs and risks of generators and consumers to ensure optimal economic outcomes and market benefits as a whole. In addition, whilst AEMO is not able to consider wider social and environmental impacts under the existing RIT-T regulatory framework, the needs of local communities and landowners are critical in the planning stage.

This VAPR sets out how continued renewable investment, especially in areas with high quality resources with weak network, could impact the required transmission build for Victoria. It identifies potential projects that could progress through the regulatory process if threshold trigger conditions were to occur, or that could be available for third-party investment outside of the existing regulatory framework. AEMO will continue to work collaboratively with the Victorian Government in identifying potential medium-term investments that may be progressed through Stage 2 of the RDP.

AEMO continues to adapt to match Victoria's dynamic environment

AEMO is delivering a connections uplift program with a strong emphasis on transparent processes, common methodologies, novel technology solutions such as the Connection Simulation Tool, improved project tracking, and enhanced modelling capabilities, to manage the volume and complexity of new connections. AEMO is also working to better utilise emerging technologies and include non-traditional and non-network options wherever possible and economic. New technologies have featured strongly in AEMO's recent investment projects, and AEMO continues to partner and support a range of research, development, and technology pilot programs across Victoria.

Contents

Executive summary	3
1. Introduction	14
1.1 Context of the 2021 VAPR	15
1.2 Supporting material	19
2. Network performance	20
2.1 How does AEMO assess network performance?	21
2.2 Victorian power system reviewable operating incidents	21
2.3 Supply-demand adequacy	25
2.4 Interconnector capability	25
2.5 Operational challenges	27
2.6 Impact of Covid 19	32
2.7 Impact of Victorian transmission constraints	33
2.8 Network performance at times of high network stress	37
3. Network developments	48
3.1 Supply changes since the 2020 VAPR	49
3.2 Renewable energy investment	51
3.3 <i>Transmission Development Plan for Victoria</i>	52
3.4 Renewable Energy Zone Development Plan (RDP) Stage 1	59
3.5 Neighbouring TNSP projects	59
4. Forecast limitations	61
4.1 Methodology	62
4.2 Emerging limitations	64
4.3 Priority limitations	64
4.4 Developing limitations	65
4.5 Other monitored transmission network limitations	66
4.6 Retirement of Yallourn Power Station	76
4.7 Power System Frequency Risk Review (PSFRR)	85
4.8 Victorian control schemes	87
4.9 Distribution planning	87
5. Asset replacement and retirements in the DSN	88
5.1 Rule requirements	89
5.2 Methodology	89
5.4 Asset renewal Regulatory Investment Test projects	95
6. Adapting to the future network	96

A1.	Distribution network service provider planning	112
A2.	DSN limitation detail	113
A2.1	Central North REZ	114
A2.2	Eastern Corridor	114
A2.3	Northern Corridor	116
A2.4	Murray River REZ	117
A2.5	South West Victoria REZ	118
A2.6	Greater Melbourne and Geelong	119
A2.7	Western Victoria REZ	122
A2.8	Victoria system-wide	122
A3.	Approach to network limitation review	123
	Abbreviations	124

Tables

Table 1	2021 VAPR supporting resources	19
Table 2	Summary of significant or reviewable power system incidents since the 2020 VAPR	22
Table 3	Percentage (%) of time interconnector is exporting energy from Victoria	26
Table 4	Net energy exported from Victoria (gigawatt hours [GWh])	26
Table 5	Historical frequency of operational measures to manage high voltages	29
Table 6	Reverse flow statistics at identified locations	31
Table 7	Equations with significant binding durations or impact – north-west Victoria	34
Table 8	Equations with significant binding durations or impact – south-west corridor	36
Table 9	Equations with significant binding durations or impact – Eastern Victoria	36
Table 10	Summary of operating conditions	37
Table 11	Maximum demand snapshot – summary operating conditions	38
Table 12	Minimum demand snapshot – summary of operating conditions	40
Table 13	High wind snapshot – summary of operating conditions	43
Table 14	High export snapshot – summary of operating conditions	45
Table 15	High solar snapshot – summary of operating conditions	46
Table 16	Additional reactive power need in Victoria for the next 10 years	73
Table 17	Unlocking new generation – limitations	84
Table 18	Network need assessment results	91
Table 19	Ovens Murray REZ health and investment options	101
Table 20	Murray River REZ health and investment options	102

Table 21	Western Victoria REZ health and investment options	102
Table 22	South West REZ health and investment options	103
Table 23	Gippsland REZ health and investment options	105
Table 24	Central North REZ health and investment options	105
Table 25	South West REZ – RDP Stage 1 Specified Augmentations	107
Table 26	Murray River REZ – RDP Stage 1 Specified Augmentations	107
Table 27	Central North REZ – RDP Stage 1 Specified Augmentations	108

Figures

Figure 1	Current, committed, and proposed large-scale generation and storage in Victoria	5
Figure 2	Transmission Development Plan for Victoria – delivered and committed projects	6
Figure 3	Summary of Victorian REZs	7
Figure 4	<i>Transmission Development Plan for Victoria</i> – future projects and priority limitations	8
Figure 5	Key context areas for the 2021 VAPR	15
Figure 6	Relationship between the ISP, VAPR, and RIT-T in the national planning framework	16
Figure 7	Victoria net export duration curve (all interconnectors)	27
Figure 8	Average periods during which 500 kV lines are switched out to manage high voltage during low demand	29
Figure 9	Available system strength units during 2019-20 (including Bogong and Murray 2)	30
Figure 10	Seven-day moving average consumption (provided by AusNet Services)	32
Figure 11	Map of the most significant Victorian transmission constraints in 2020-21	33
Figure 12	Maximum demand snapshot – generation, load, and interconnector flow	39
Figure 13	Victorian demand profile of maximum demand day (11 January 2021)	40
Figure 14	Minimum demand snapshot – generation, load, and interconnector flow	41
Figure 15	Victorian demand profile of minimum demand day (25 December 2020)	42
Figure 16	Rooftop PV capacity and maximum generation by financial year and number of daytime minimum demand days	42
Figure 17	High wind snapshot – generation, load, and interconnector flow	44
Figure 18	High export snapshot – generation, load, and interconnector flow	46
Figure 19	High solar snapshot – generation, load, and interconnector flow	47
Figure 20	Existing, committed and proposed large-scale generation capacity in Victoria, October 2021	51
Figure 21	Renewable development in the ISP Central (updated demand) scenario by 2029-30	52
Figure 22	Transmission development plan – delivered and committed projects	53
Figure 23	Transmission development plan – future projects and priority limitations	53

Figure 24	Identification of network limitations – the planning cycle	63
Figure 25	Priority limitations and developing limitations under investigation	66
Figure 26	Summary of identified limitations by location (including priority, developing, and monitored)	67
Figure 27	Minimum operational demand thresholds in Victoria	70
Figure 28	Operational demand projection duration curves by financial year	70
Figure 29	Projected inertia in Victoria	72
Figure 30	2021 ESOO forecast 90% POE shoulder minimum operational demand (sent-out) for Victoria (Central scenario)	73
Figure 31	Latrobe Valley in radial mode	77
Figure 32	Latrobe Valley in parallel mode	77
Figure 33	CBTS A1 500/220 kV transformer load duration curve	80
Figure 34	Rowville A1 500/220 kV transformer load duration curve	80
Figure 35	HWTS transformer load (under system normal) duration curve	81
Figure 36	HWTS transformer load (under contingency) duration curve	81
Figure 37	HWPS – YPS 220 kV line load (under contingency) duration curve	82
Figure 38	RWTS – TTS 220 kV line load (under contingency) duration curve	82
Figure 39	TSTS – TTS 220 kV line load (under contingency) duration curve	83
Figure 40	Current Victorian connections pipeline	98
Figure 41	Summary of Victorian REZs	99

1. Introduction

This chapter introduces the purpose and content of the 2021 *Victorian Annual Planning Report* (VAPR), including the key regulatory, policy, operational, network, and connections context in which the report has been prepared.

Purpose, scope, and structure of the 2021 VAPR

The Australian Energy Market Operator (AEMO) publishes the VAPR in its role as the Victorian transmission planner under the NEL, in accordance with clause 5.12 of the NER.

The VAPR 2021 assesses the adequacy of the existing Victorian Declared Shared Network (DSN) to meet reliability and security needs in the past year and for planning and directing augmentation on the forecast DSN over the next 10 years, by adapting to the changing nature of demand, and considering changes in the geography and characteristics of supply in the context of Victorian Government policy and regulatory settings. It builds on the national plan developed through AEMO's *Integrated System Plan* (ISP), and provides local insights relating to network capability, system performance, and emerging augmentation needs.

The VAPR studies provide insights relating to network security, reliability of supply, forecast demand, network capability, system performance, and emerging network development needs, with a particular focus on those most likely to deliver net economic benefits and lower costs for consumers.

In the 2021 VAPR:

- Chapter 2 reviews the performance of the DSN throughout 2020-21, including new operational challenges, notable power system incidents, performance of the network under a range of operating conditions, and the impact of COVID-19.
- Chapter 3 provides an update on the network investment activities and investigations that have progressed since 2020 to facilitate the integration of new renewable generation while supporting Victorian power system security and reliability.
- Chapter 4 explores potential new emerging or changed limitations that may reduce system performance, impact efficient asset utilisation, or result in additional network constraints. Identified limitations may warrant heightened monitoring, further options analysis, or trigger the need for investment.
- Chapter 5 presents updated information on AusNet Services' Asset Renewal Plan, outlining expected network asset retirements, deratings, and renewals within the VAPR timeframe, including AEMO's assessment of the future network needs associated with these assets.
- Chapter 6 provides a range of insights into future transmission planning in the Victorian DSN, considering both current and emerging trends in technology and geography. The chapter provides a range of information to assist new and intending participants to better understand the changing investment landscape in Victoria.

The 2021 VAPR is also supported by an online interactive map that provides data and analysis for a range of National Electricity Market (NEM) topics, including current and emerging development opportunities and national transmission plans.

1.1 Context of the 2021 VAPR

The energy landscape in Victoria continues to change, driven by strong investment in large-scale and distributed renewable generation in traditional load centres and remote locations. New large-scale investment in the west of the state is creating additional supply centres, while increasing penetration of non-synchronous generation continues to impact system stability and the operational complexity of the power system. Consumer-led investment in distributed energy resources (DER) has altered the shape of the daily demand curve, and is creating new challenges through new record levels of minimum demand, while the growth of DER and large-scale renewable generation is decreasing levels of reactive power, inertia, and system strength.

The context for network development is changing rapidly, both nationally and regionally, with multiple moving pieces across regulatory, policy, operational, network and connection areas.

Figure 5 summarises the key context areas that are each explored in more depth in this chapter.

Figure 5 Key context areas for the 2021 VAPR

Policy and regulatory	Operational challenges	Network development
<ul style="list-style-type: none"> National regulatory framework Renewable energy targets. Government initiatives. Regulatory changes and processes. 	<ul style="list-style-type: none"> Impacts of the COVID-19 pandemic. Existing challenges: <ul style="list-style-type: none"> Minimum demand. Emerging challenges: <ul style="list-style-type: none"> Negative demand forecast. Impacts of committed and anticipated connections and retirements. Changing dynamics of power flow. Maintenance outage windows. 	<ul style="list-style-type: none"> Committed projects. Projects currently being assessed. Retirement of coal generation. Volume of renewable connections.

1.1.1 Policy and regulatory

Policy and regulatory changes have a significant impact on network projects including the identification of newly emerging limitations, and the changing nature of planning in the DSN.

The national planning framework

- AEMO, the Council of Australian Governments (COAG), and the Energy Security Board (ESB) have jointly progressed changes to the national transmission planning framework to make the ISP 'actionable'. These reforms implement a streamlined regulatory framework that allows outputs from the ISP to be incorporated into transmission network service provider (TNSP) investment decisions.⁸ Under this approach:
- Comprehensive system-wide modelling in the ISP identifies network needs and a set of options that deliver the highest net market benefits when considered nationally, and as part of an optimised plan.
- The VAPR leverages these nationally optimised plans and overlays them with more granular information about local congestion issues and regional performance characteristics.

⁸ See <http://www.coagenergycouncil.gov.au/publications/actionable-isp-final-rule-recommendation>.

- The VAPR studies are then used to inform interested parties in Victoria, trigger regulatory investment processes, or flow back into the ISP to improve and refine subsequent publications.
- Together, the ISP and the VAPR initiate the Regulatory Investment Test for Transmission (RIT-T) process, which then aims to validate project benefits, explore lower-cost variations, and ensure any subsequent investment decision is robust and transparent. This relationship is presented in Figure 6.

Figure 6 Relationship between the ISP, VAPR, and RIT-T in the national planning framework

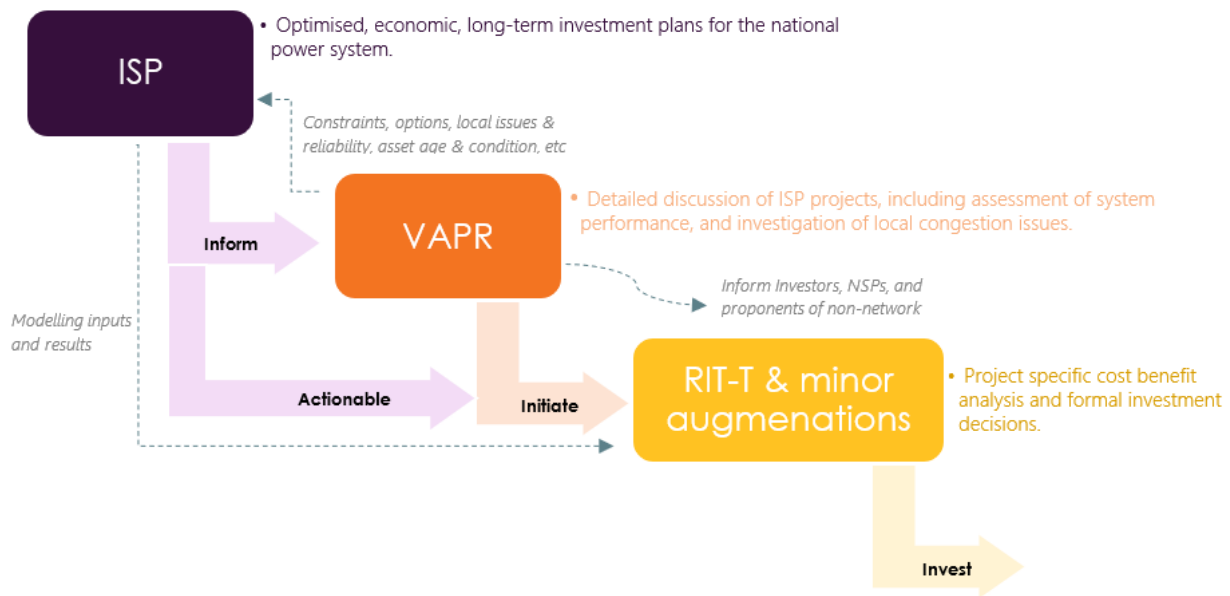

Renewable energy targets and government initiatives

The Victorian Government has made several policy announcements and commitments that are impacting on the drivers for, and economics of, investment in the Victorian network. It has:

- Expanded the Solar Homes Program⁹ to include a Solar for Business Program and a Small Business Energy Saver Program¹⁰, covering up to 50% of the cost of a rooftop solar system, while small businesses will be eligible for a rebate up to \$3,500. These initiatives effectively reduce operational demand in Victoria.
- Legislated a Victorian Renewable Energy Target (VRET) for 50% of Victoria’s electricity to be supplied by renewable energy sources by 2030, in addition to previously legislated targets of 25% by 2020 and 40% by 2025.
- Announced a second VRET Auction (VRET2)¹¹, aiming to bring online at least 600 megawatts (MW) of new renewable energy capacity in Victoria by 2024.
- Announced a \$1.6 billion clean energy package through the 2020–21 Victorian State Budget to invest in renewables, grid infrastructure, energy efficiency, and decarbonisation projects. This included a \$540 million Renewable Energy Zone (REZ) Fund to help develop the six Victorian REZs AEMO identified in the ISP.
- Established VicGrid as a division within Victoria’s Department of Land, Water and Planning (DELWP) to oversee the planning and development of the Victorian REZs. The entity will administer the \$540 million REZ fund. The Victorian Government will continue to develop the framework for determining future

⁹ See <https://www.solar.vic.gov.au/>.

¹⁰ See <https://www.solar.vic.gov.au/supporting-small-business-cut-costs-and-increase-efficiency>.

¹¹ See <https://www.energy.vic.gov.au/renewable-energy/vret2>.

transmission investment in REZs, VicGrid's proposed role in that framework, and the government's broader approach to developing Victorian REZs.

- Amended the *National Electricity Victoria Act* (NEVA), to allow priority augmentation projects to be fast-tracked with respect to the Victorian Declared Transmission System¹². This gives Victorian Government the power to direct investment in transmission network projects in Victoria, without the need to complete a regulatory process.
- Published a REZ Development Plan (RDP) Directions Paper¹³ identifying potential Stage 1 (near-term) projects and Stage 2 (longer-term) projects to unlock up to 10 GW of renewable energy capacity. The Victorian Minister for Energy, Environment and Climate Change, Lily D'Ambrosio, subsequently made a Ministerial Order under section 16Y of the NEVA, directing AEMO to undertake procurement processes to progress three contestable RDP projects for services to strengthen the system, as well as three sets of non-contestable RDP minor network augmentations.

Regulatory changes and processes

The following regulatory processes also impact on AEMO's operational and investment activities:

- The ESB has recommended reforms to redesign the NEM to support an orderly transition to a modern energy system and see an energy system that can deliver affordable, smart and clean energy to consumers¹⁴. These reforms range from market incentives for supply, power system security, DER and transmission. Current transmission access and congestion is proposed to be addressed by supporting the integration of REZs and supporting timely and efficient transmission investment.
- On 21 October 2021, the Australian Energy Market Commission (AEMC) made a final determination on the efficient management of system strength on the power system¹⁵. This rule aims to deliver system strength in the grid when and where it is needed. It is part of the suite of tools required to keep the power system stable and secure as it decarbonises. System strength is a critical service that supports inverter-based resources (IBR), such as wind and solar generation, as well as batteries, which are rapidly becoming a key part of the NEM generation mix. See Section 4.5.2 for more information on how this rule affects AEMO's planning activities for the Victorian DSN.
- On 19 April 2021, AEMO submitted a new proposed pricing methodology to the Australian Energy Regulator (AER) for the 2022-27 regulatory control period¹⁶. On 12 October 2021, the AER released a draft determination¹⁷ to not approve the proposed pricing methodology. AEMO continues to consult with the AER and customers to reach agreement on a pricing methodology for the 2022-27 period.

1.1.2 Operational context

Existing operational challenges

- Voltage control during record low demand periods requires frequent operator interventions including 500 kilovolt (kV) line switching and the use of Non-Market Ancillary Services (NMAS).
- Managing power system security during high semi-scheduled generation periods, especially in north-west Victoria is causing congestion and raising new power system stability challenges.

¹² See <https://www.legislation.vic.gov.au/as-made/acts/national-electricity-victoria-amendment-act-2020>.

¹³ See https://www.energy.vic.gov.au/_data/assets/pdf_file/0016/512422/DELWP_REZ-Development-Plan-Directions-Paper_Feb23-updated.pdf.

¹⁴ See <https://esb-post2025-market-design.aemc.gov.au/>.

¹⁵ See <https://www.aemc.gov.au/rule-changes/efficient-management-system-strength-power-system>.

¹⁶ See <https://www.aer.gov.au/networks-pipelines/determinations-access-arrangements/aemo-determination-2022-27>.

¹⁷ See <https://www.aer.gov.au/system/files/AER%20-%20Draft%20Decision%20-%20AEMO%20transmission%20determination%202022-27%20-%20October%202021.pdf>.

- In response to the system strength shortfall in the West Murry region, AEMO secured services¹⁸ from two providers in the Red Cliffs region in August 2020, to meet the amended fault levels requirements. Monitored limitations in western parts of the state continue to present stability risks and outage planning challenges requiring a minimum number of synchronous generators to be online.
- The generation fleet across Victoria is aging and therefore its reliability and availability is progressively decreasing. Furthermore, generator capability degrades during extreme weather conditions.

Emerging operational challenges

- Energy Australia has announced that Yallourn Power Station (YPS) will retire all four units in mid-2028. This is expected to shift the power flow dynamic in Victoria. A study has been conducted to assess the impacts on the Victorian grid.
- With reducing minimum demand forecast, voltage control and system strength issues are expected to be exacerbated. The significant amount of large-scale renewable generation anticipated to connect, and the announced retirement of YPS, are expected to exacerbate outage management challenges in the future.

1.1.3 Network development

Since the 2020 VAPR, significant progress has been made across a range of network planning and investment activities, which have either been completed or materially progressed during this period.

The 2021 VAPR explores the progress and significance of these developments in Chapter 3 Network developments, and discusses ongoing works to maintain and refurbish the existing transmission network in Chapter 5 Asset replacement and retirements in the DSN.

¹⁸ See https://aemo.com.au/-/media/files/electricity/nem/security_and_reliability/system-security-market-frameworks-review/2020/notice-of-change-to-red-cliffs-220kv-minimum-fault-level-requirement-and-shortfall.pdf?la=en&hash=5C3EDDABDF81891B3989F6FF0466C486.

1.2 Supporting material

AEMO has published a suite of electronic resources to support the content in this report. Descriptions are provided in Table 1.

Unless otherwise indicated, all files are published alongside the VAPR report on the AEMO website¹⁹.

Table 1 2021 VAPR supporting resources

Resource	Description
Historical DSN rating and loading workbook	Presents ratings and loadings for the 2020-21 maximum demand and high export periods presented in Chapter 2 and the interactive map.
AusNet Services 2021 asset renewal plan	Outlines AusNet Services' transmission asset renewal process and provides a list of its planned asset renewal projects, including asset retirements and de-ratings for the next 10-year period, including changes since last year and the various options considered.
Asset related datasets	<ul style="list-style-type: none"> • Transmission connection point data for each transmission terminal station where primary station assets are associated with an actual or forecast emerging network limitation. • Transmission line segment data for each transmission line between terminal stations that are associated with a historical or emerging line capacity limitation. • Aggregated generation connection data for each connection application or new (completed over the last 12 months) connection agreement at terminal stations or areas where the connections could affect existing or emerging network limitations.
Interactive map	<p>Provides data and analysis for a range of NEM topics including emerging development opportunities, transmission connection point forecasts, short-circuit levels, and national transmission plans.</p> <p>At https://www.aemo.com.au/aemo/apps/visualisations/map.html.</p>
Constraint reports	<p>AEMO uses constraint equations to operate the DSN securely within power system limitations. The constraint equations are implemented in the National Electricity Market Dispatch Engine (NEMDE), which dispatches generation to ensure operation within the bounds of power system limitations. AEMO's annual and monthly constraint reports detail the historical performance of these constraint equations.</p> <p>At https://www.aemo.com.au/energy-systems/electricity/national-electricity-market-nem/system-operations/congestion-information-resource/statistical-reporting-streams.</p>
Demand forecasts	<p>AEMO's independent connection point forecasts for Victoria.</p> <p>Detailed information on the forecasts, together with the forecast methodology and recent changes can be found in AEMO's website at https://www.aemo.com.au/energy-systems/electricity/national-electricity-market-nem/nem-forecasting-and-planning/forecasting-and-planning-data/transmission-connection-point-forecasting/victoria.</p> <p>The transmission connection point planning report, prepared by the Victorian Distribution Network Service Providers (DNSPs), provides information on historical and forecast demand, including DNSP's terminal station demand forecast (TSDF) and the causes of differences between these and AEMO's connection point forecasts for Victoria.</p> <p>At https://www.unitedenergy.com.au/wp-content/uploads/2020/12/Transmission-Connection-Planning-Report-2020.pdf.</p>

¹⁹ At <https://www.aemo.com.au/en/energy-systems/electricity/national-electricity-market-nem/nem-forecasting-and-planning/victorian-planning/victorian-annual-planning-report>.

2. Network performance

This chapter reviews the performance of the Victorian DSN throughout 2020-21, including new operational challenges, notable power system incidents, and the performance of the network under a range of operating conditions.

Key network performance observations

The Victorian DSN remained secure in 2020-21, despite record low minimum demand and unprecedented levels of IBR generation. Notable network performance observations are that:

- Milder weather conditions over the 2020-21 summer period led to a 13% reduction in maximum operational demand, from 9,667 MW in 2019-20 to 8,411 MW on 11 January 2021. Temperatures in Melbourne were approximately 35°C at the time. No Reliability and Emergency Reserve Trader (RERT) contracts were activated in 2020-21.
- Victoria recorded its all-time lowest minimum demand of 2,529 MW on 25 December 2020; it was 688 MW lower than the previous record set in 2017-18. This is the first year that a minimum demand record was set during daylight hours. Daily minimum demands occurred during daylight hours on 111 separate occasions during 2020-21, up from 51 reported in the previous VAPR, highlighting the impact of increasing distributed photovoltaic (PV) investment.
- These minimum demands continue to drive the need for operator interventions to manage high voltages on the network. These actions included de-energising 500 kV lines and activating NMAS. While the number of interventions decreased from the previous year, the average time of each intervention was higher. The installation of a new reactor at Keilor Terminal Station in 2021 has acted to reduce intervention durations again. A further three reactors will be commissioned under the Victorian Reactive Power Support project before the 2022-23 summer, which will significantly reduce the need for operator intervention to manage high voltages.
- Several terminal stations that have historically behaved as net loads increasingly behaved as net generation sources due to increases in distribution-connected generation. This year, nine locations experienced reverse flows, up from seven locations in 2019-20, and an additional two terminal stations experiencing reverse flows on individual transformers, including one of the Bendigo transformers experiencing reverse flows due to distributed PV.
- Several extended network outages were required over 2020-21 to accommodate the installation of new renewable generators and network upgrades in the north-west of Victoria. These outages resulted in significant periods of constraint on local generators to maintain voltage stability.
- There were five reviewable power incidents in 2020-21 which resulted in loss of loads or generation:
 - On 11 April 2020, multiple generating units and distributed PV totalling 1,091 MW tripped due to a fault, however there was no loss of load.
 - On 20 August 2020, multiple generating units tripped for the trip of a single line, totalling 247 MW; the trip of one of the generating units was unexpected and was determined to have occurred due to an overly sensitive protection scheme. No load was lost.

- On 8 September 2020, both the Wodonga Terminal Station (WOTS) 330 kV transformers unexpectedly tripped due to a 66 kV distribution feeder fault, resulting in the loss of the No. 1 and No. 2 330 kV busbars at WOTS, disconnection of the Dederang (DDTS) – WOTS and WOTS – Jindera (JIND) 330 kV lines and the loss of 44 MW of customer load for 63 minutes. The DDTS – WOTS and WOTS-JIND 330 kV lines were returned to service within 12 minutes.
- On 23 November 2020, both the WOTS 330 kV transformers unexpectedly tripped due to a 22 kV distribution feeder fault, resulting in the loss of the No. 1 and No. 2 330 kV busbars at WOTS, disconnection of the DDTS-WOTS and WOTS-JIND 330 kV lines and the loss of 52 MW of customer load for 62 minutes. The DDTS-WOTS and WOTS-JIND 330 kV lines were returned to service within 19 minutes.
- On 3 May 2021, both the WOTS 330 kV transformers unexpectedly tripped due to a 22 kV distribution feeder fault, resulting in the loss of the No. 1 and No. 2 330 kV busbars at WOTS, disconnection of the DDTS-WOTS and WOTS-JIND 330 kV lines, and the loss of 34 MW of customer load for 19 minutes. The DDTS-WOTS and WOTS-JIND 330 kV lines were returned to service within 13 minutes.

2.1 How does AEMO assess network performance?

In evaluating the adequacy of the Victorian DSN, AEMO considered the following key performance indicators:

- **Notable power system incidents** – the frequency of incidents which resulted in system security violation or loss of customer load or generation (Section 2.2).
- **Supply-demand adequacy** – the extent to which the operation of the network facilitated or hindered the ability of the power system to meet customer demand (Section 2.3).
- **Interconnector capability** – the extent to which the operational and design limits of interconnectors restricted the import and export of generation (Section 2.4).
- **Operational challenges** – how network operation was impacted by the changing technical characteristics and geography of supply, particularly where such changes increased operational complexity (Section 2.5).
- **Impact of COVID-19** – the effects of COVID-19 restrictions on the network (Section 2.6).
- **Impact of constraint equations** – the severity of network constraints (Section 2.7).
- **Behaviour of the transmission network at time of high network stress** – the network’s ability to supply demand at times of high demand, and maintain voltages at times of low demand (Section 2.8).

In this chapter, unless otherwise stated:

- Generation is defined as all scheduled, semi-scheduled, and non-scheduled generation greater than 30 MW, and does not include distributed PV systems.
- Demand and consumption are as generated, meaning they include generator auxiliary loads²⁰.
- Rooftop PV refers to PV systems up to 100 kW capacity.

2.2 Victorian power system reviewable operating incidents

AEMO plans, designs, and maintains the Victorian DSN to meet system normal conditions and to remain secure following any single credible contingency event.

²⁰ For further information on demand and consumption definitions, see https://www.aemo.com.au/Electricity/National-Electricity-Market-NEM/~/_/media/31828D130AF64F8084BF893CFFD3B301.ashx.

Over the review period (1 July 2020 to 30 June 2021), the DSN was operated in a secure state. The reviewable operating incidents²¹ in Table 2 highlight periods where unexpected failure of power system elements resulted in significant impacts on power system operations.

This section does not consider distribution network events that may have also resulted in a loss of supply.

Of the seven incidents shown in Table 2, two relate to maloperation of anti-islanding protection during non-islanded conditions, and two concern loss of AEMO and NSP Supervisory Control and Data Acquisition (SCADA) systems. The two incidents on 11 April 2020 and 20 August 2020 relate to operation of anti-islanding protection in non-islanded conditions. In both cases, the anti-islanding protection operated due to unexpected voltage waveform distortion. These incidents highlight the challenges of planning and operating the DSN under changing system conditions.

Notably absent from this list are non-credible contingency events caused by extreme weather conditions such as bushfires and storms, compared to three such events listed in the 2020 VAPR. Victoria experienced milder summer conditions in 2020-21, with average Melbourne temperatures below 25°C for the first time since 2011²².

Table 2 Summary of significant or reviewable power system incidents since the 2020 VAPR

Date	Incident	Consequence
11 April 2020 ^A	Trip of Yallourn generating units 1, 3, 4 and four Macarthur Wind Farm collector groups.	1,091 MW of generation reduction in Victoria. No customer load reduction.
20 August 2020	Trip of Ararat – Crowlands 220 kV line and Wemen Solar Farm.	247 MW of generation reduction in Victoria. No customer load reduction.
8 September 2020	Trip of WOTS transformers.	Disconnection of DDTS-WOTS and WOTS-JIND 330 kV lines. Loss of 44 MW of customer load.
23 November 2020	Trip of WOTS transformers.	Disconnection of DDTS-WOTS and WOTS-JIND 330 kV lines. Loss of 52 MW of customer load.
24 January 2021	NEM-wide SCADA failure.	No customer load reduction or generation reduction.
16 February 2021	Victoria-wide SCADA failure.	No customer load reduction or generation reduction.
3 May 2021	Trip of WOTS transformers.	Disconnection of DDTS-WOTS and WOTS-JIND 330 kV lines. Loss of 34 MW of customer load.

A. This event occurred during the 2020 VAPR reporting period, but was not included because investigations had not yet been completed at the time of publication.

11 April 2020

On 11 April 2020, a single phase to ground fault at YPS at 13:26:41 hrs resulted in the disconnection of three generating units at YPS and four collector groups at Macarthur Wind Farm²³.

Yallourn Unit 3 tripped 255 MW of generation, four Macarthur Wind Farm collector groups tripped 291 MW, and Yallourn Units 1 and 4 ramped back 475 MW of combined generation over two minutes before

²¹ For the full definition of “reviewable operating incident”, see clause 4.8.15 of the NER. AEMO’s published reports about operating incidents are at <https://aemo.com.au/energy-systems/electricity/national-electricity-market-nem/nem-events-and-reports/power-system-operating-incident-reports>.

²² See AEMO, Quarterly Energy Dynamics, Q1 2021, Figure 1, at <https://aemo.com.au/-/media/files/major-publications/qed/2021/q1-report.pdf?la=en>.

²³ See https://aemo.com.au/-/media/files/electricity/nem/market_notices_and_events/power_system_incident_reports/2020/yallourn-134-and-macarthur-wf-investigation-report-11-april-2020.pdf?la=en.

disconnecting. Approximately 70 MW of distributed PV generation also tripped due to the reduction in voltage caused by the phase to ground fault. Altogether the incident resulted in the loss of 1,091 MW of generation. There was no loss of load.

The single phase to ground fault was the result of severe weather dislodging a conductor. All protection systems operated as expected to clear the fault.

Investigation revealed that the disconnection of the three Yallourn units was due to incorrect settings on protection systems. The disconnection of four Macarthur Wind Farm collector groups was due to a firmware error in the calculation of the rate of change of frequency (RoCoF) element in the generator's anti-islanding protection relay. The phase shift associated with the fault resulted in a spurious frequency measurement, and the error in the RoCoF element caused this model of protection relay to operate. This calculation error in the protection relay is common to all collector groups Y protection relays at Macarthur Wind Farm, and if the voltage waveform as a result of the fault was slightly different it was feasible that all collector groups could have tripped.

Changes to the relevant protection settings at both Yallourn and Macarthur Wind Farm have since been implemented and tested to address the root cause of maloperation.

20 August 2020

On 20 August 2020, the Ararat – Crowlands 220 kV line (ARTS-CWTS line) in western Victoria tripped, which resulted in operation of the Generator Fast Trip (GFT) control scheme²⁴. The GFT scheme operated as designed to disconnect 184 MW of wind generation between Ararat and Murra Warra terminal stations. The event also resulted in an unexpected trip of the Wemen Solar Farm from 63 MW of generation. In total, 247 MW of generation output disconnected as a result of this incident. No customer load was lost as a result of this incident.

AEMO has concluded that:

- The trip of ARTS-CWTS line was caused by a maloperation of X current differential protection due to its sensitive current differential threshold setting. There was no fault on the line.
- The trip of Wemen Solar Farm was due to an unexpected operation of the anti-islanding scheme where no islanding condition existed. This was caused by the voltage vector shift protection and its sensitivity to power system disturbances. The vector shift protection has since been disabled to prevent a recurrence of the incident.
- The DSN remained in a secure operating state throughout this incident.

AEMO is concerned about potential inadvertent operation of anti-islanding schemes such as vector shift or RoCoF protection for external disturbances which do not result in islanding. This has the potential to exacerbate disturbances on the power system by increasing the impact of the contingency event. AEMO plans to engage further with NSPs across the NEM to understand the issue and subsequently consider actions that may be required.

Through the review of this event, AEMO identified intermittent 19 hertz (Hz) oscillations in the West Murray area; this is discussed further in Section 2.5.1.

24 January 2021 and 16 February 2021

Operation of the DSN relies heavily on information technology (IT). Due to the prevalence of IT systems, when these systems fail, they have the potential to impact operation of the DSN in the following ways:

- Constraint violations or constraint input failures.
- Loss of visibility of power system alarms or status.

²⁴ See https://aemo.com.au/-/media/files/electricity/nem/market_notices_and_events/power_system_incident_reports/2020/trip-ararat-crowlands-line-20-aug-2020.pdf?la=en.

- Loss of communications between AEMO and NSPs.
- Mal-operation of special protection schemes.

In the 2021 financial year, Victoria experienced two separate state-wide failures of SCADA systems, both lasting approximately one hour. While the DSN remained in a secure operating state throughout each SCADA failure, these incidents have been included in the VAPR to build awareness of the risks associated with operating a modern power system.

NEM SCADA Failure 24 January 2021

From approximately 1546 hrs on 24 January 2021, AEMO's internal SCADA service failed²⁵. TNSPs were requested to monitor the power system and advise AEMO of any issues. Normal operation of SCADA was restored by 1656 hrs on the same day.

Preliminary investigations by AEMO determined the SCADA failure related to a vendor system software bug that affected the replication process on the active servers to the point where it caused outages with internal SCADA communications processes. AEMO initiated the discussion with relevant NSPs and Emergency Coordination Teams to effectively respond to the event.

In response to the incident, a vendor-issued software patch has been applied on all affected servers.

Victorian SCADA Failure 16 February 2021

At 0703 hrs on 16 February 2021, all Victorian SCADA failed at AusNet Services and subsequently AEMO²⁶. During the Victorian SCADA failure, AusNet Services could log in to a limited number of displays and carry out limited switching operations using a secondary system. The SCADA system returned to normal operation at 0807 hrs on 16 February 2021. At the time of SCADA failure, Murraylink runback operated from 185 MW to 0 MW due to loss of the runback control scheme. This is the expected response from Murraylink when SCADA is lost.

The Victorian SCADA failure was caused by failure of the server's Solid State Drives (SSDs) exceeding their runtime. AusNet Services has applied a firmware update to all impacted SSDs to reduce the probability of re-occurrence.

8 September 2021, 23 November 2021, and 3 May 2021

On three occasions (8 September 2020²⁷, 23 November 2020²⁸ and 3 May 2021²⁹) both WOTS 330/66/22 kV transformers unexpectedly tripped for a distribution feeder fault, resulting in the loss of WOTS No. 1 and No. 2 330 kV busbars at WOTS and the DDTs-WOTS and the WOTS-JIND 330 kV lines. The trip of these transformers impacted the DSN due to the circuit breaker configuration at Wodonga which trips both busbars at the terminal station for the loss of these transformers, reducing the transfer capability along the VNI.

In each incident, both busbars were returned to service within 20 minutes and interconnector constraints did not bind. The load loss in each of these incidents ranged from 34 MW to 52 MW at WOTS and would have occurred even without the loss the 330 kV busbars. The loss of both transformers is not a credible contingency event, and the root cause of each of these incidents was incorrect protection settings. These have since been addressed by a protection setting audit by AusNet Services.

²⁵ See https://aemo.com.au/-/media/files/electricity/nem/market_notices_and_events/power_system_incident_reports/2021/final-report-total-loss-of-nem-scada-data.pdf?la=en.

²⁶ See section 9.2 https://aemo.com.au/-/media/files/electricity/nem/market_notices_and_events/power_system_incident_reports/2021/final-report-total-loss-of-nem-scada-data.pdf?la=en.

²⁷ See https://aemo.com.au/-/media/files/electricity/nem/market_notices_and_events/power_system_incident_reports/2020/trip-of-no1-and-no-2-wodonga-330-kv-transformers.pdf?la=en.

²⁸ See https://aemo.com.au/-/media/files/electricity/nem/market_notices_and_events/power_system_incident_reports/2020/trip-of-no-1-and-no-2-wodonga-330-kv-transformers.pdf?la=en.

²⁹ See https://www.aemo.com.au/-/media/files/electricity/nem/market_notices_and_events/power_system_incident_reports/2021/trip-of-wodonga-330kv-transformers.pdf?la=en.

2.3 Supply-demand adequacy

The supply-demand balance in Victoria was maintained in 2020-21, with no emergency reserves needing to be dispatched through RERT. This compares to RERT being dispatched twice in 2019-20, in December 2019³⁰ and January 2020³¹. Actual Lack of Reserve (LOR)³² was declared once in 2020-21, on 21 April 2021³³, compared to four days in 2019-20.

Milder weather conditions over the summer period meant lower cooling requirements in Melbourne³⁴, and a lower peak summer demand in 2020-21 was recorded at 8.4 GW, compared to 9.7 GW in 2019-20. The lack of need for emergency mechanisms during system normal conditions indicates that the DSN is continuing to meet the needs of consumers.

In 2020-21, the total supply in Victoria increased compared to the previous year, as a result of:

- 472 MW of newly commissioned large-scale wind and solar (see Section 3.1).
- Increased availability of brown coal generation; three or more brown coal units were simultaneously out of service for 22% this year compared to 31% in the previous year.

A reduction in output at YPS³⁵ was recorded in mid-June 2021 due to heavy rainfall which resulted in the cracking of the Morwell River Diversion wall³⁶. AEMO's latest *Electricity Statement of Opportunities* (ESOO)³⁷ finds that were another significant rainfall event to occur, keeping the entire power station out of service for 12-18 months, expected unserved energy (USE) in Victoria would fail to meet the reliability standard. While the likelihood of such an event is relatively low, the consequence could be significant if the risk is not mitigated. AEMO is working with the Victorian Government to explore options that could help mitigate this risk.

The 2021 ESOO also forecast that breaches of the reliability standard are unlikely until 2028-29 when the YPS is announced for retirement in 2028. However, it finds that the addition of advanced projects that do not yet meet AEMO's commitment criteria would be sufficient to bring expected USE down below the reliability standard throughout the next decade in Victoria. This includes the 350 MW, four-hour, large-scale Jeeralang Battery being developed by 2026 as part of Energy Australia's agreement with the Victorian Government to deliver an orderly retirement of YPS³⁸. This is further discussed in Section 4.6.

2.4 Interconnector capability

An interconnector's capability depends on the performance of the network, which varies throughout the year. AEMO publishes notional interconnector limits in its Interconnector Capabilities Report³⁹, and a detailed summary of the capability and limits of each interconnector in the NEM in its Monthly and Annual NEM Constraint Reports⁴⁰.

³⁰ See https://aemo.com.au/-/media/files/electricity/nem/%20emergency_management/rert/2020/rert-quarterly-report-q4-2019.pdf?la=en.

³¹ See https://www.aemo.com.au/-/media/files/electricity/nem/%20emergency_management/rert/2020/rert-quarterly-report-q1-2020.pdf?la=en.

³² See <https://aemo.com.au/energy-systems/electricity/national-electricity-market-nem/system-operations/power-system-operation/nem-lack-of-reserve-framework-quarterly-reports>.

³³ See https://aemo.com.au/-/media/files/electricity/nem/security_and_reliability/power_system_ops/lack-of-reserve-framework-quarterly-reports/2021/q2-report.pdf?la=en.

³⁴ See AEMO, Quarterly Energy Dynamics, Q1 2021, Figure 1, at <https://aemo.com.au/-/media/files/major-publications/qed/2021/q1-report.pdf?la=en>.

³⁵ See <https://aemo.com.au/-/media/files/major-publications/qed/2021/q2-report.pdf?la=en&hash=00DE50F7BD940383B9D367FF7A78D6B0>.

³⁶ See <https://www.energyaustralia.com.au/about-us/media/news/energyaustralia-statement-yallourn-mine>.

³⁷ See https://aemo.com.au/-/media/files/electricity/nem/planning_and_forecasting/nem_esoo/2021/2021-nem-esoo.pdf?la=en&hash=D53ED10E2E0D452C79F97812BDD926ED.

³⁸ While this project does not yet meet AEMO's commitment criteria, as part of an agreement with the Victorian Government, Energy Australia has committed to developing Jeeralang Battery before Yallourn retires. See <https://www.energyaustralia.com.au/about-us/energy-generation/yallourn-power-station/energy-transition>.

³⁹ See https://www.aemo.com.au/-/media/Files/Electricity/NEM/Security_and_Reliability/Congestion-Information/2017/Interconnector-Capabilities.pdf.

⁴⁰ See <https://www.aemo.com.au/energy-systems/electricity/national-electricity-market-nem/system-operations/congestion-information-resource/statistical-reporting-streams>.

Table 3 and Table 4 provide an indication of trends in Victoria’s exports to other regions across the interconnectors. Since the closure of Hazelwood Power Station in 2017, there has been a significant reduction in the quantity and time Victoria has spent exporting power to neighbouring regions.

However, a reversal of this trend was observed in 2020-21, with exports into neighbouring regions either increasing or remaining the same. This was consistently observed throughout the entire year.

Table 3 Percentage (%) of time interconnector is exporting energy from Victoria

Interconnector	5-year average before Hazelwood closure	2018-19	2019-20	2020-21
VNI	84%	50%	56%	71%
Heywood	82%	42%	37%	47%
Murraylink	46%	50%	63%	63%
Basslink	44%	42%	44%	58%
Victoria (net)	87%	50%	50%	72%

Table 4 Net energy exported from Victoria (gigawatt hours [GWh])

Interconnector	5-year average before Hazelwood closure	2018-19	2019-20	2020-21
VNI	4,032	953	1,174	2,338
Heywood	1,824	-388	-534	-117
Murraylink	48	-36	152	289
Basslink	-533	-496	-512	611
Victoria (net)	5,371	33	279	3,122

Note: Victorian export volumes were incorrectly reported in the VAPR 2020. Historical values have been corrected in Table 4.

The Heywood interconnector continues to operate below its maximum design limit of 650 MW in both directions, due to stability risks which were identified following the South Australia black system event in 2016⁴¹. The maximum transfer currently allowed is 600 MW from Victoria to South Australia, and 550 MW from South Australia to Victoria. The current capacity limit will be increased once residual operational concerns are fully addressed for both steady-state and transient conditions.

Heywood flows from South Australia to Victoria were constrained further below this limit to 420 MW from 17 July 2020, due to the permanent failure of the Parafield Gardens No. 1 static Var compensator (SVC) due to a fire. This constraint was binding for 7% of the financial year and this constraint is expected to remain in place until the SVC is replaced, which is expected in early 2022.

Heywood flows were further limited 10-30 MW on average below 420 MW through periods of February and March 2021 while the temporary towers erected to repair damage caused by the convective downburst on 31 January 2020⁴² were replaced with permanent structures.

⁴¹ AEMO, Black System in South Australia, 28 September 2016, March 2017, listed under 2016 reports at <https://www.aemo.com.au/energy-systems/electricity/national-electricity-market-nem/nem-events-and-reports/power-system-operating-incident-reports>.

⁴² See https://aemo.com.au/-/media/files/electricity/nem/market_notices_and_events/power_system_incident_reports/2020/final-report-vic-sa-separation-31-jan--2020.pdf?la=en.

Figure 7 presents the Victorian net export duration curves for the past five years. This shows a step increase in 2020-21 of net exports from the low export levels recorded in the previous three years following the closure of Hazelwood Power Station in 2017. The following drivers behind increased Victorian exports were identified in AEMO’s Quarterly Energy Dynamics reports⁴³:

- Higher exports into South Australia and New South Wales driven by lower demand in Victoria, higher brown coal availability, and the commissioning of new wind and solar generation in Victoria. Exports into New South Wales were particularly promoted by black coal outages in New South Wales over the spring shoulder season in Q4 2020.
- Higher exports into Tasmania were driven primarily by dry conditions in Tasmania reducing hydro generation availability.

AEMO expects that exports will continue to increase over time as new renewable generation is connected in Victoria to meet the VRET, and as new network projects are deployed, particularly the VNI Upgrade (see Section 3.3.4), to reduce constraints and facilitate increased transfer capacity. These exports are expected to grow steadily until the retirement of further thermal power stations in the Latrobe Valley.

Figure 7 Victoria net export duration curve (all interconnectors)

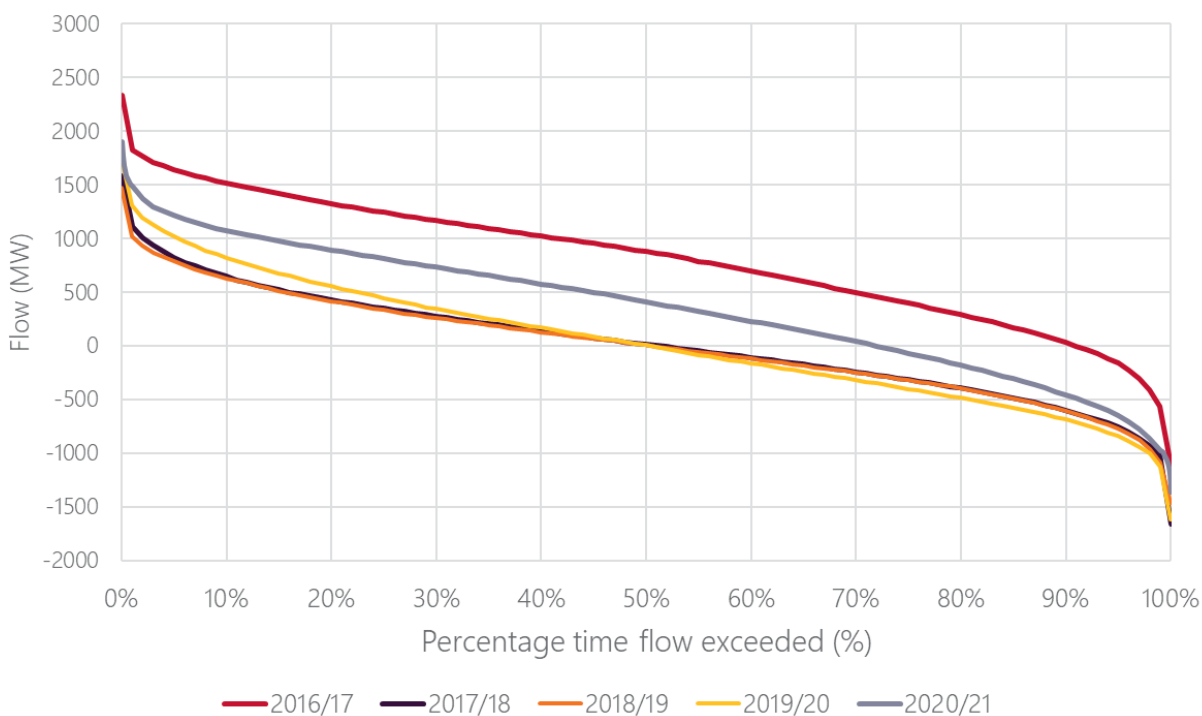

2.5 Operational challenges

This section discusses how network operation has been impacted over the past year by the changing technical characteristics and geography of supply, particularly where this has reduced system resilience, resulted in additional network constraints, or otherwise increased operational complexity.

2.5.1 West Murray considerations

Voltage oscillations under prior outage conditions

As discussed in the 2020 VAPR, AEMO has identified that during prior outages in the Western Victoria and Murray River REZs, a subsequent contingency event may cause undamped voltage oscillations.

⁴³ At <https://aemo.com.au/energy-systems/major-publications/quarterly-energy-dynamics-qed>.

These oscillations have the potential to cause further disruption or voltage collapse. To maintain power system security during these prior outage conditions, network constraints are applied to reduce the output of local generating units during specific prior outages.

Over the past two years, there have been several new generators commissioned in the region and also a number of outages to either connect these generators or for other upgrade works or for maintenance. This has resulted in high binding hours for this group of constraints, as indicated in Section 2.7.

Sub-synchronous oscillations

As discussed in Section 2.2, during investigations of a power system incident on 20 August 2020, AEMO identified intermittent 19 Hz oscillations in the West Murray area. Normally, these sub-synchronous oscillations of 16-19 Hz are intermittent and low in magnitude (around 0.5% peak to peak voltage) and can last from under a minute to several minutes. Occasionally they are high in magnitude (around 1% peak to peak voltage) and from a few seconds to sometimes over a few minutes in duration. The oscillations are initiating with and without network disturbances.

AEMO is working with relevant NSPs to install appropriate monitoring equipment across the West Murray area, and is engaging with NSPs, participants, and the broader power system engineering community nationally and internationally to identify and where possible resolve issues⁴⁴.

System strength shortfall

As discussed in the 2020 VAPR, AEMO is progressing remediation of a fault level shortfall identified at Red Cliffs Terminal Station (more information is in Section 3.3.5).

2.5.2 Impact of record minimum demand

Voltage management

Under minimum demand conditions, and without operator intervention, high voltages can occur on the Victorian transmission network. Short-term operational measures, such as de-energising a 500 kV transmission line, have become normal practice during these periods to maintain system voltage requirements. Projected reductions in minimum demand over the next decade, linked with rapid uptake in DER, will act to further exacerbate this issue.

Reliance on voltage control interventions results in higher market costs, reduced system resilience, and higher system security risks. Table 5 summarises the frequency with which these measures have been used for voltage control over the past two years.

The following solutions are being utilised to manage network voltages:

- In 2019, AEMO entered into an NMAS agreement with a generation proponent to provide additional reactive capabilities on request. AEMO uses this contract operationally while long-term solutions are in the process of being delivered.
- In 2020, AEMO and AusNet Services agreed to upgrade an over-voltage protection scheme to increase the permitted 500 kV post contingent voltage at Keilor. This is also an interim measure as network solutions are being delivered.
- In 2021, a 100 megavolt-amperes reactive (MVAR) reactor was installed by AusNet Services as part of a Network Capability Incentive Parameter Action Plan (NCIPAP) at Keilor Terminal Station (KTS).
- AEMO has also procured a further 300 MVAR of reactive plant through the Victorian Reactive Power Support project (see Section 3.3.3).

⁴⁴ For more information, see AEMO's "Sub-Synchronous Oscillations in the West Murray Area" presentation, at https://aemo.com.au/-/media/files/electricity/nem/network_connections/west-murray/sub-synchronous-oscillations-in-the-west-murray-area.pdf?la=en.

- It is also expected that new and anticipated large-scale renewable energy plant and battery energy storage systems will further assist in the management of high voltages during low demand conditions.

Table 5 Historical frequency of operational measures to manage high voltages

Operational measure	Number of times action was taken							
	Q3 2019	Q4 2019	Q1 2020	Q2 2020	Q3 2020	Q4 2020	Q1 2021	Q2 2021
De-energise first 500 kV line	14	29	15	14	10	20	3	6
Activate NMAS ^A	0	17	20	14	6	25	7	0
De-energise second 500 kV line	0	2	2	2	1	5	0	0
Issue directions	0	0	1	0	0	0	0	0
Total actions	14	48	36	30	17	50	10	6

Note: Historical data in this table has been updated based on latest information since the 2020 VAPR.

A. In March 2019, AEMO entered a short-term NMAS agreement for voltage control support at times of minimum demand.

As demand continues to fall each year, not only is the minimum demand getting lower, but the duration of time below the low demand threshold for which operator interventions are required to manage high voltages also increases. Periods during which lines are switched out to manage high voltages are more frequently spanning multiple days, with a record 12-day long period in 2021 starting before Christmas 2020 and lasting until after New Year's Day 2021.

Figure 8 shows the increasing periods during which 500 kV lines have been operationally switched out to manage high voltages during lengthening low demand periods. The average outage duration reduced notably in Q2 2021 after AusNet Services installed a reactor at KTS.

Figure 8 Average periods during which 500 kV lines are switched out to manage high voltage during low demand

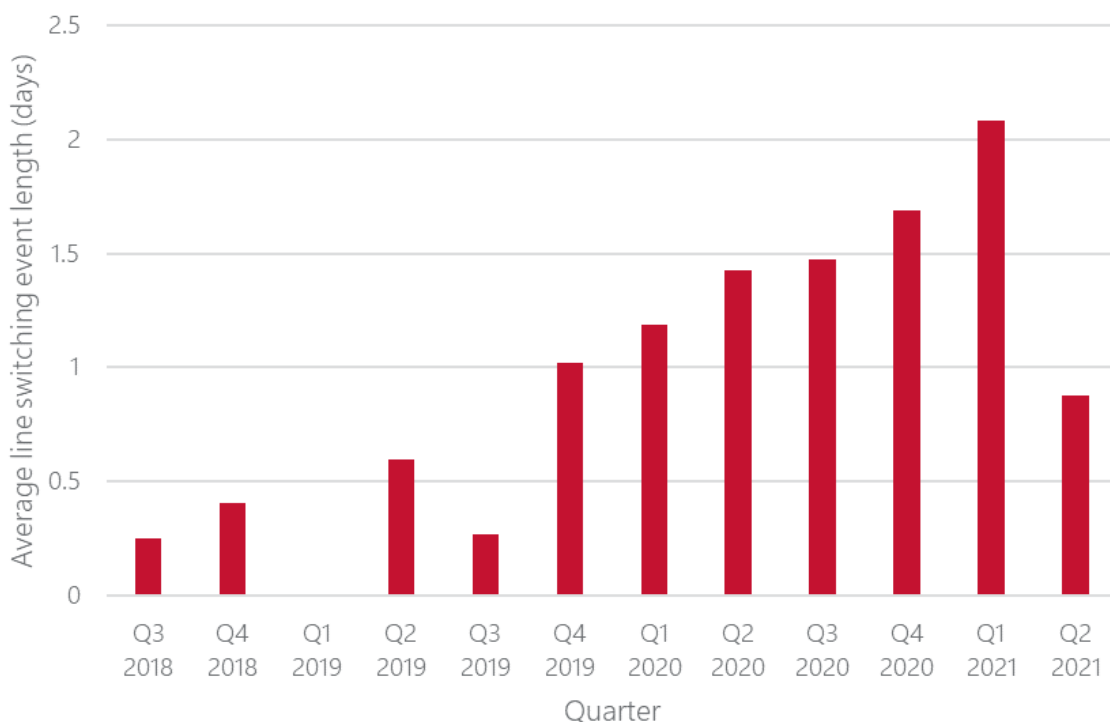

Minimum synchronous units to maintain system strength

A minimum level of system strength is required for a power system to maintain and control the voltage waveform both during steady state operation and following a disturbance. To maintain system strength in Victoria, specific combinations of synchronous units must always remain online⁴⁵.

These unit combinations have an aggregate minimum generation requirement of between 800 MW and 1,600⁴⁶ MW, representing the threshold for operational demand below which Victoria must export to neighbouring regions to maintain enough local sources of system strength. As identified in the 2021 ESOO⁴⁷, the minimum operational demand in Victoria is expected to fall within this threshold range by 2023 and below this threshold range from 2025 in the Central scenario. Under the Slow Change scenario these thresholds may be met earlier. This is considered further in Section 4.5.

Although Victoria is well connected with its neighbouring regions, there is a low probability of separation of both South Australia and Victoria from the rest of the mainland. This has a minimum requirement for system strength, for a combined operational demand of 1.8 GW to 3.5 GW.

Figure 9 shows the frequency of units online over the last 12 months for generators contained in at least one viable Victorian system strength combination. In general, valid combinations require the equivalent of five large thermal units online (with lower levels possible when compensated by several peaking units).

Victoria has operated with 7-9 units providing system strength, 10% more in 2020-21 compared to 2019-20. As minimum demands fall in future years, this curve is expected to shift further to the left, increasing the risk of system strength interventions to maintain the required synchronous units online. Future network investment may be required to remediate this issue, and AEMO is monitoring these needs through an annual outlook of system strength issues (see Section 4.5.2).

Figure 9 Available system strength units during 2019-20 (including Bogong and Murray 2)

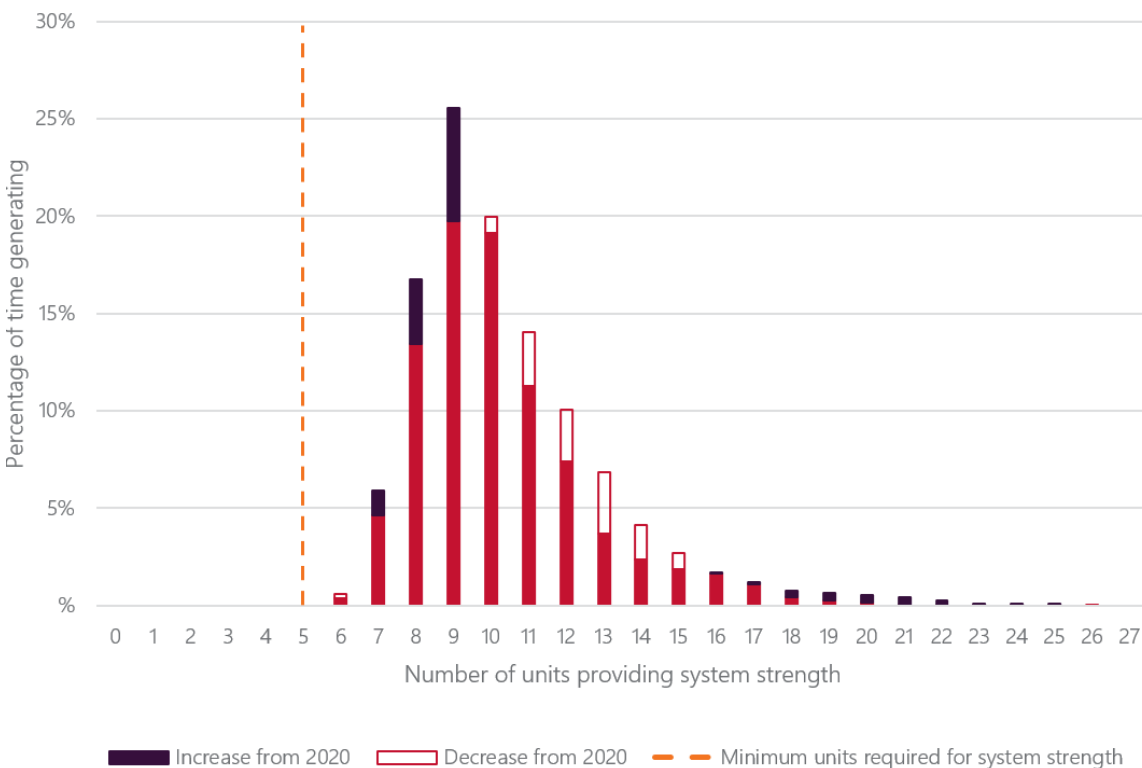

⁴⁵ See AEMO's latest system strength combinations for Victoria at <https://www.aemo.com.au/energy-systems/electricity/national-electricity-market-nem/system-operations/congestion-information-resource/limits-advice>.

⁴⁶ The 2020 VAPR reported a range of 800 MW to 1,200 MW; after further analysis this has been revised to a range from 800 MW to 1,600 MW.

⁴⁷ See Section A5.5 of the 2021 ESOO, at https://aemo.com.au/-/media/files/electricity/nem/planning_and_forecasting/nem_esoo/2021/2021-nem-esoo.pdf?la=en&hash=D53ED10E2E0D452C79F97812BDD926ED.

2.5.3 Reverse power flows

The increasing volume and geographic distribution of generators connecting at the sub-transmission and distribution level is causing some terminal stations (that have historically behaved as net loads) to increasingly act as net generation sources to the transmission network. Section 3.1 provides more detail on new generator connections that have occurred since the 2020 VAPR was published.

The frequency and magnitude of these ‘reverse power flows’ continues to increase in Victoria, with nine terminal stations experiencing such flows in 2020-21. This is up from seven terminal stations reported in the 2020 VAPR, and with increased durations observed across most stations.

The Horsham 220/66 kV transformers are an exception to this trend, in that they have continued to experience significantly fewer reverse flows each year since 2018-19. The output from connected generation remained consistent over the period, however minor changes in consumption patterns and increased local energy consumption have contributed to relatively fewer periods with a net reverse flow.

Table 6 outlines the number of hours that reverse flows occurred at these nine terminal stations over the last three years and notes the associated new distribution connected projects at each location.

Table 6 Reverse flow statistics at identified locations

Transformer location	Hours with reversed flows (2020-21)	Hours with reversed flows (2019-20)	Hours with reversed flows (2018-19)	Notes
Wemen 220/66 kV	3,546	3,241	1,926	
Terang 220/66 kV	2,343	2,905	2,288	
Kerang 220/66/22 kV	2,657	2,646	2,504	
Horsham 220/66 kV	290	827	1,358	
Red Cliffs 220/66/22 kV	1,933	477	536	Yatpool Solar Farm started generation in December 2020 and system strength constraints were removed from Karadoc Solar Farm in April 2020.
Shepparton 220/66 kV	1,534	940	0	Increase in DER
Ballarat 220/66 kV	1,912	838	0	Yendon Wind Farm achieved full commissioning in early 2020.
Glenrowan 220/66 kV	592	0	0	Glenrowan West Solar Farm and Winton Solar Farm
South Morang 220/66 kV	14	0	0	Cherry Tree Wind Farm

In addition to the nine terminal stations, two other terminal stations experienced reverse power flows on a subset of the transformers installed at the terminal station:

- This year, small amounts of reverse flows were experienced solely due to uptake of distributed PV across one of the transformers at Bendigo Terminal Station for the first time. This occurred in total for 108 hours in the last year.
- Geelong Terminal Station experienced reverse power flow for 11 hours on two of its 220/66 kV transformers that form the 66 kV tie to Terang Terminal Station. This was likely due to high rooftop PV generation being coincident with high wind farm generation on the 66 kV tie.

These statistics confirm the impact that changes in the distribution and sub-transmission network are having at a transmission level.

Injections into the transmission network are expected to grow over time, particularly as further generation projects connect and DER offsets local demand to create periods of surplus supply in the distribution network. This will present new operational and network planning challenges to both TNSPs and distribution network services providers (DNSPs).

2.6 Impact of Covid 19

From mid-March 2020, nationwide restrictions and drastic lifestyle changes were put into effect in response to the COVID-19 pandemic. These restrictions escalated and changed over subsequent months, and limited commercial business activity while driving rapid changes in electricity consumption patterns.

While total electrical consumption has not notably changed due to COVID-19 restrictions, on a sector basis, COVID-19 initially resulted in a significant increase residential demand in Victoria, offset by corresponding decreases in commercial and large business demand.

Figure 10 below shows the seven-day moving average of consumption in Victoria for the full years of 2019 and 2020 and up to April for 2021, overlaying COVID-19 restricted periods in 2020.

Small and medium enterprise (SME) and large industrial demand changes are responsive to COVID-19 restrictions, with 2020 consumption falling below 2019 trends. Meanwhile, residential demand trended high in 2020 relative to the previous year, even after initial COVID-19 restrictions were removed. This may be attributed to the normalisation of working from home.

During Victoria’s second period of COVID-19 restrictions in 2020, residential demand maintained a downward trend consistent with 2019, and remained so after restrictions were removed. This is likely attributable to milder temperatures during spring, and continued uptake of rooftop PV offsetting increases in residential demand.

Figure 10 Seven-day moving average consumption (provided by AusNet Services)

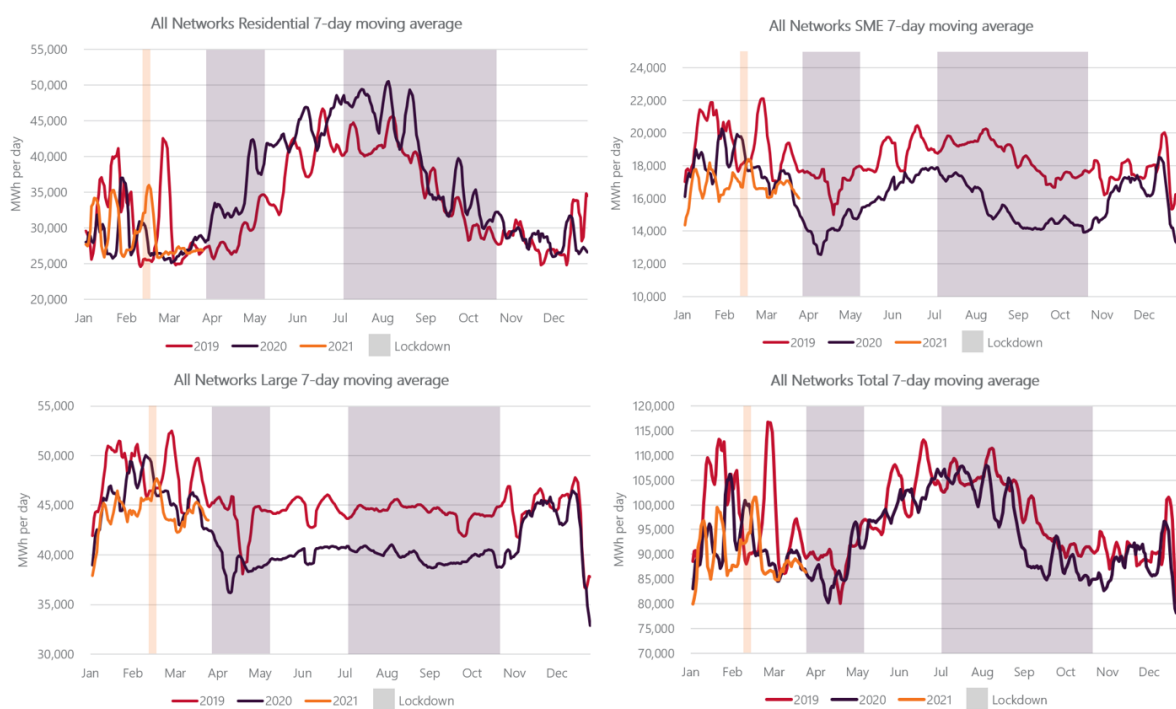

2.7 Impact of Victorian transmission constraints

This section summarises the Victorian transmission network constraints that resulted in the highest dispatch impact during the 2020-21 financial year. Comparison values are also shown for the 2019-20 financial year.

The ranking of each constraint (or group of constraints) is determined by the calculated 'binding impact' of the constraints. The binding impact of a constraint is derived by combining the marginal value for each dispatch interval over the period considered. It is used to distinguish between the severity of different binding constraint equations and represents the relative financial impact associated with that constraint equation. However, it does not represent the market benefit from investment to remove the constraint in absolute terms.

Figure 11 summarises these constraints by type and location around the Victorian system.

While the constraints summarised in this section are those with the most significant impact historically, investment to remove any specific constraint would also require consideration of limitations that may bind immediately behind these limits and reduce the benefits unless those constraints are also alleviated.

For example, investment to remove Constraint 5 in Figure 11 would not result in unconstrained flows along Wemen to Kerang, as this constraint competes for dominance against Constraint 7. In other parts of the state, constraints that currently do not bind at all may begin to bind as other limits are removed.

To assess the true benefits of relieving constraints, AEMO undertakes detailed power system and economic modelling through prefeasibility and RIT-T processes (see Chapter 4).

Figure 11 Map of the most significant Victorian transmission constraints in 2020-21

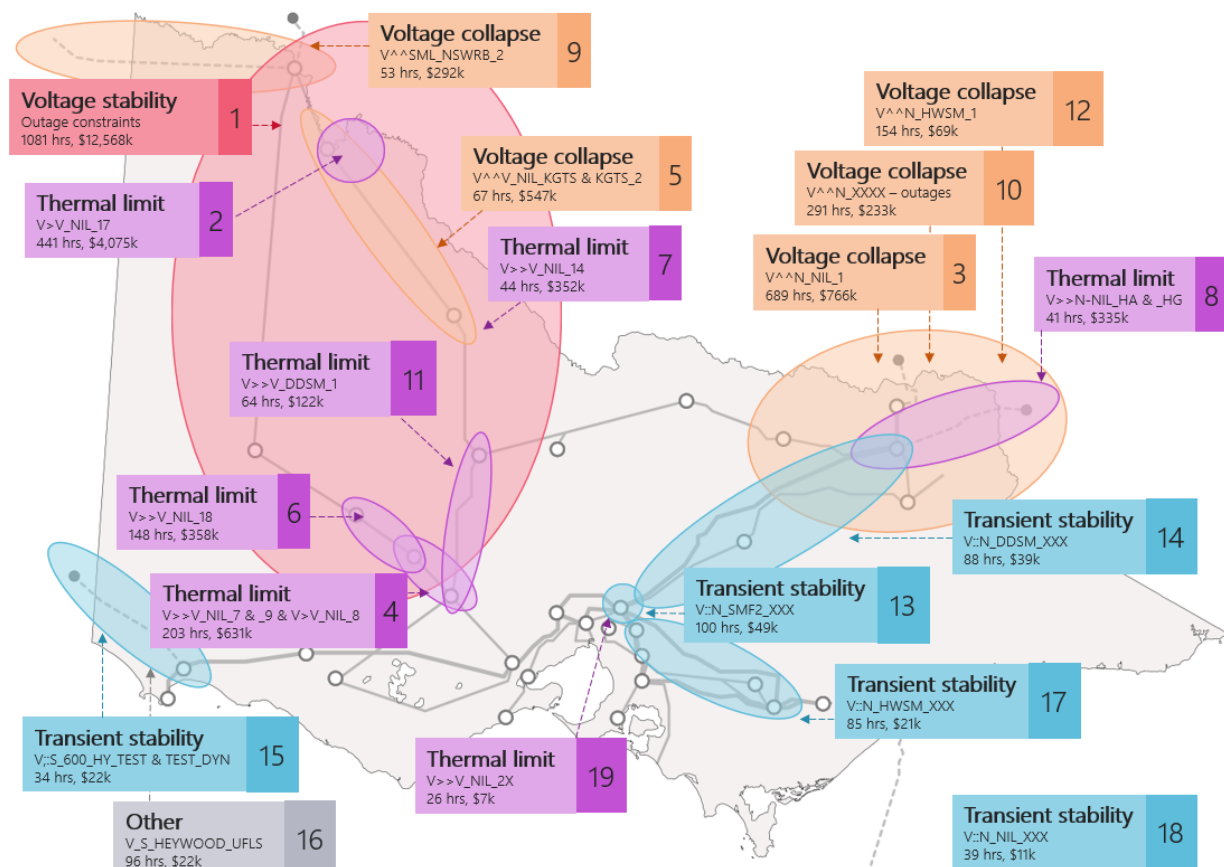

- Constraint impact is measured as the sum of marginal values for a constraint, and provides indicative impacts on dispatch outcomes. This is a guide, but does not reflect the financial impacts on individual generators, or the market benefits available under a regulatory test.
- The top ranked constraint represents a collection of prior outage limitations that applied during a set of planned network outages required to facilitate new connections in the north-west of Victoria.

Western Victoria and Murray River

The transmission network in the west of Victoria and in the Murray River region has been characterised by significant new renewable generation investment, and accompanying outages to facilitate connection and commissioning of these projects. This is a relatively weak part of the network, subject to voltage stability and voltage collapse constraints that have limited flows and generation over the last 12 months. As new generators are connected, many lines in the area are reaching their thermal limits. Table 7 presents further information on these limitations.

Table 7 Equations with significant binding durations or impact – north-west Victoria

Rank	Equation	Binding hours		Binding impact		Description
		2019-20	2020-21	2019-20	2020-21	
1	North-west Vic voltage oscillation (prior outage)	585 ^A	1081 ^A	\$3,583k ^A	\$12,568k ^A	This represents a set of the network constraint equations associated with voltage oscillation during a range of prior outage conditions. AEMO is continuously reviewing these constraints as revised models are obtained and based on upcoming outage schedule. Projects being considered as a part of the Victorian Government's RDP may help reduce the impact of these constraints.
2	Wemen Transformer thermal ^B V>V_NIL_17	-	441	-	\$4,075k	To prevent pre-contingent overload of Wemen 220/66 kV transformer (not part of DSN).
4	Waubra Terminal Station (WBTS)-Ballarat Terminal Station (BATS) Thermal V>>V_NIL_7 ^C , V>V_NIL_8 and V>>V_NIL_9.	94 ^C	203	\$118k ^C	\$631k	To avoid overloading the Waubra to Ballarat 220 kV line on trip of the Red Cliffs to Wemen to Kerang 220 kV line or Kiamal to Red Cliffs 220 kV line or Kerang to Bendigo 220 kV line. V>>V_NIL_7 came into effect in September 2020. Projects being considered as a part of the Victorian Government's RDP may help reduce the impact of these constraints.
5	Wemen to Kerang voltage stability V^^V_NIL_KGTS and V^^V_NIL_KGTS_2	-	67	-	\$547k	To limit post-contingency flow on Wemen to Kerang for loss of Horsham to Murra Warra to Kiamal or Horsham to Bulgana to Crowlands to avoid voltage collapse. These constraints came into effect in March 2021 and were modified in August 2021 which should increase the limit and reduce binding hours further. AEMO is progressing a project to implement changes to the Murraylink Very Fast Runback (VFRB) scheme to adapt to current system conditions and reduce the impact of these constraints. A temporary modification has been implemented as an interim solution. Services to increase the capability of the system to remain stable with additional generation being considered through the Victorian Government's RDP may help reduce the impact of these constraints.

Rank	Equation	Binding hours		Binding impact		Description
		2019-20	2020-21	2019-20	2020-21	
6	ARTS-WBTS Thermal V>>V_NIL_18	-	148	-	\$358k	To prevent post-contingent overload of Ararat to Waubra 220 kV on trip of Kerang to Bendigo 220 kV. This constraint was invoked in November 2020. Projects being considered as a part of the Victorian Government's RDP may help reduce the impact of this constraint.
7	WETS-KGTS Thermal V>>V_NIL_14	-	44	-	\$352k	To prevent post-contingent overload of Wemen to Kerang 220 kV on trip of Horsham to Murra Warra to Kiamal 220 kV. This constraint was invoked in August 2020. A NCIPAP project to remove station limitations at Wemen and Kerang Terminal Stations and install windspeed monitoring on the Wemen to Kerang line, completed in August 2021, is expected to alleviate this limitation.
9	Red Cliffs voltage stability V^^SML_NSWRB_2	103	53	\$346k	\$292k	To avoid voltage collapse at Red Cliffs for the loss of Darlington Point to Balranald (X5) or Balranald to Buronga (X3) 220 kV lines when the New South Wales Murraylink runback scheme is unavailable. Services to increase the capability of the system to remain stable with additional generation being considered through the Victorian Government's RDP may reduce the impact of this constraint.

A. This is the sum of the binding hours and binding impacts for multiple constraint equations during prior outage and system normal conditions (45 in 2021 and 37 in 2020). These values may be overestimated due to constraints binding concurrently.

B. These transformers are not DSN assets but have been included for completeness.

C. V>>V_NIL_7 first came into effect in 2020-21.

South West corridor and the Heywood interconnector

In 2020-21 there were two high-impact constraints in the South West corridor:

- A transient stability limitation that restricts exports from Victoria to South Australia. This constraint represents a 600 MW limit to ensure oscillatory stability, and has been applied as part of the test program to further release Heywood Interconnector capacity.
- A constraint limiting Heywood flows during high rooftop PV generation to ensure South Australia can maintain sufficient load for emergency under frequency load shedding (UFLS) controls to operate effectively. This constraint was introduced in October 2020⁴⁸.

Table 8 provides further details on each of these limitations.

⁴⁸ See <https://www.aemo.com.au/-/media/files/initiatives/der/2020/heywood-ufls-constraints-fact-sheet.pdf?la=en>.

Table 8 Equations with significant binding durations or impact – south-west corridor

Rank	Equation	Binding hours		Binding impact		Description
		2019-20	2020-21	2019-20	2020-21	
15	Heywood transient stability V:S_600_HY_TEST and V:S_600_HY_TEST_DYN	62	34	\$20k	\$22k	600 MW limit on Victoria to South Australia transfer on Heywood with dynamic headroom.
16	Heywood Emergency Control Scheme management V_S_HEYWOOD_UFLS	-	96	-	\$22k	Limit Heywood flows when South Australia UFLS is insufficient to manage for double-circuit loss of Heywood IC.

Eastern Victoria and Victoria – New South Wales Interconnector

Constraints in the east of Victoria are primarily dominated by limitations across the VNI. There are several thermal constraints limiting flows between South Morang and Murray, while voltage stability limits flows across the border region.

The market impact of VNI constraints markedly increased in 2020-21 compared to previous years, due to frequent high price events in New South Wales in June 2021, associated with the North Queensland load shedding event on 25 May 2021. AEMO is addressing the thermal constraints experienced during export to New South Wales through the VNI Upgrade project to upgrade interconnector capacity from Victoria into New South Wales (see Section 3.3.4).

In the south-east, transient stability constraints have continued to bind more frequently, due to outages on 330 kV and 500 kV lines. In 2020-21, these outages were driven by continued Hazelwood to South Morang 500 kV line switching to manage high voltages during low demand, and planned outages of Dederang to South Morang 330 kV lines associated with the VNI Upgrade project. The South Morang 330/500 kV F2 transformer was also simultaneously taken out of service for maintenance. Further outages of Dederang to South Morang 330 kV lines are planned during 2021-22. Outages on the 500 kV and 330 kV lines are expected to decrease progressively on delivery of AEMO’s development plan discussed in Chapter 3.

The thermal constraints associated with Victorian import thermal limits from New South Wales ($V > V_{NIL_7}$, $V > V_{NIL_5}$, $V > V_{NIL_3}$, and $V > V_{NIL_1A}$), featured in the 2020 VAPR, either did not bind or bound for very short periods of time with minimal market impact in 2021. This is because the 2020-21 summer experienced lower maximum demand than the 2019-20 summer.

Table 9 provides further details on each of the above limitations.

Table 9 Equations with significant binding durations or impact – Eastern Victoria

Rank	Equation	Binding hours		Binding impact		Description
		2019-20	2020-21	2019-20	2020-21	
3	VNI voltage collapse $V \wedge \wedge N_NIL_1$	350	689	\$141k	\$766k	To avoid voltage collapse in northern Victoria and southern New South Wales for loss of Alcoa Portland (APD) potlines following fault on one of the 500 kV lines in South West Victoria (light load, high export to New South Wales).
8	VNI thermal overload $V > N_NIL_HG$ & $V > N_NIL_HA$	65	41	\$35k	\$335k	To prevent overloading of VNI Murray to Upper Tumut 65 line both pre-contingent and post-contingent for loss of Murray to Lower Tumut 66 line.

Rank	Equation	Binding hours		Binding impact		Description
		2019-20	2020-21	2019-20	2020-21	
10	VNI voltage collapse during outages	-	291	-	\$232k	Avoid voltage collapse around Murray for loss of all APD potlines during planned transmission equipment outages.
11	BATS-BETS thermal V>>V_DDSM_1	-	64	-	\$122k	To prevent post-contingent overload of Ballarat to Bendigo during outage of one Dederang to South Morang line for loss of the remaining Dederang to South Morang line.
12	VNI voltage stability V^^N_HWSM_1	44	154	\$17k	\$69k	Avoid voltage collapse around Murray for loss of all APD potlines during outage of Hazelwood to South Morang.
13	Transient stability V::N_SMF2_xxx	-	100	-	\$49k	Prevent transient instability during outage of South Morang F2 Transformer.
14	Transient stability V::N_DDSM_xxx	18	88	\$4k	\$39k	Prevent transient instability during outage of Dederang to South Morang.
17	Transient stability V::N_HWSM_xxx	153	85	\$48k	\$21k	Prevent transient instability during outage of Hazelwood to South Morang.
18	Transient stability V::N_NIL_xxx	31	39	\$6	\$11k	Prevent transient instability for fault and trip of Hazelwood to South Morang line during system normal.
19	V>>V_NIL_2X	68	26	\$12k	\$7k	To avoid pre-contingent overload of South Morang F2 500/330kV transformer.

2.8 Network performance at times of high network stress

AEMO has reviewed the loading of DSN network elements to assess levels of network stress since the 2020 VAPR.

To understand how the network performed at times of high stress, AEMO used five operational ‘snapshots’ of the power system to capture network conditions during periods of maximum demand, minimum demand, high wind generation, high solar generation, and high exports to New South Wales.

This discussion is complemented by additional information provided in the historical DSN rating and loading workbook⁴⁹. While Victorian annual minimum demand has historically occurred overnight, it has instead occurred during daylight hours every year since 2019 due to the increasing uptake of DER.

Table 10 Summary of operating conditions

	Maximum demand snapshot	Minimum demand snapshot	High export into NSW snapshot	High Wind snapshot	High Solar snapshot
Date and time^A	11 Jan 2021 5pm	25 Dec 2020 1pm	14 Jun 2021 5pm	7 Jun 2021 5pm	30 Mar 2021 12:30pm
Temperature at Melbourne Airport	34.5 °C	18.5 °C	11.3 °C	14.3 °C	18.25 °C

⁴⁹ For the maximum demand snapshot ratings and loadings, see <https://www.aemo.com.au/energy-systems/electricity/national-electricity-market-nem/nem-forecasting-and-planning/victorian-planning/victorian-annual-planning-report>.

	Maximum demand snapshot	Minimum demand snapshot	High export into NSW snapshot	High Wind snapshot	High Solar snapshot
Victorian operational demand at time of snapshot ^B	8,411 MW	2,529 MW	5,757 MW	6,304 MW	4,023 MW
Victorian generation at time of snapshot	8,063 MW	3,665 MW	6,791 MW	7,181 MW	4,575 MW
Victorian available generation capacity at time of snapshot ^C	8,785 MW	5,373 MW	7,382 MW	7,952 MW	5,564 MW
Net power flow into Victoria via interconnection	270 MW	-1156 MW	-841 MW	-727 MW	-615 MW
Rooftop PV	605 MW	1,653 MW	36 MW	38 MW	1,640 MW
Large scale renewable generation in Victoria	3,230 MW	773 MW	1,561 MW	2,499 MW	913 MW
Battery storage	3 MW	0 MW	8 MW	5 MW	1 MW
RERT dispatched	0 MW	0 MW	0 MW	0 MW	0 MW
System security	System normal, no contingency overloads	Line de-energised for voltage, NMAS utilised for voltage control	System normal, no contingency overloads	System normal, no contingency overloads	System normal, no contingency overloads

A. All values listed, excluding temperature, are the values measured at the exact time of each snapshot for the region of Victoria.

B. Operational demand is the sum of all Victorian loads and network losses.

C. Available generation capacity is the maximum capacity (MW output) at the time of the snapshot. It does not include capacity from generators that were out of service. It is equal to actual generation for all semi-scheduled and non-scheduled generators

2.8.1 Maximum demand snapshot

The maximum demand snapshot captures conditions when many network elements experience their maximum loading for the year. Table 11 and Figure 12 show the prevailing conditions at the time of maximum operational demand in Victoria (5.00 pm 11 January 2021).

Table 11 Maximum demand snapshot – summary operating conditions

Characteristic	Value (MW)	Notes
Victorian operational demand ^A	8,411	The maximum operational demand was below the 50% probability of exceedance (POE) maximum demand forecast of 9,266 MW and below the 10% POE maximum demand forecast of 10,254 MW ^B .
Sum of Victorian loads	8,155	72% (5,862 MW) was concentrated in Greater Melbourne and Geelong.
Sum of Victorian generation	8,063	53% (4,239 MW) of Victorian generation originated from the Eastern Corridor.
Sum of Victorian available generation capacity	8,785	
Net power flow into Victoria via interconnection	270	-395 MW on the VNI (New South Wales). +256 MW on the Heywood Interconnector (South Australia). -16 MW on the Murraylink Interconnector (South Australia).

Characteristic	Value (MW)	Notes
		+425 MW on the Basslink Interconnector (Tasmania).
Rooftop PV	605	Serving 7% of end user demand.
Battery storage	3	
Victorian large scale renewable generation	3,230	Representing 40% of total Victorian generation, and comprising: <ul style="list-style-type: none"> 194 MW of non-scheduled wind. 949 MW of dispatched wind. 148 MW of dispatched solar. 1,940 MW of hydroelectric generation.
RERT dispatched	0	
Other system security considerations	System normal, no contingency overloads	

A. Operational demand is the sum of all Victorian loads and network losses.

B. AEMO, 2020 ESOO, at <https://aemo.com.au/en/energy-systems/electricity/national-electricity-market-nem/nem-forecasting-and-planning/forecasting-and-reliability/nem-electricity-statement-of-opportunities-esoo>.

Figure 12 Maximum demand snapshot – generation, load, and interconnector flow

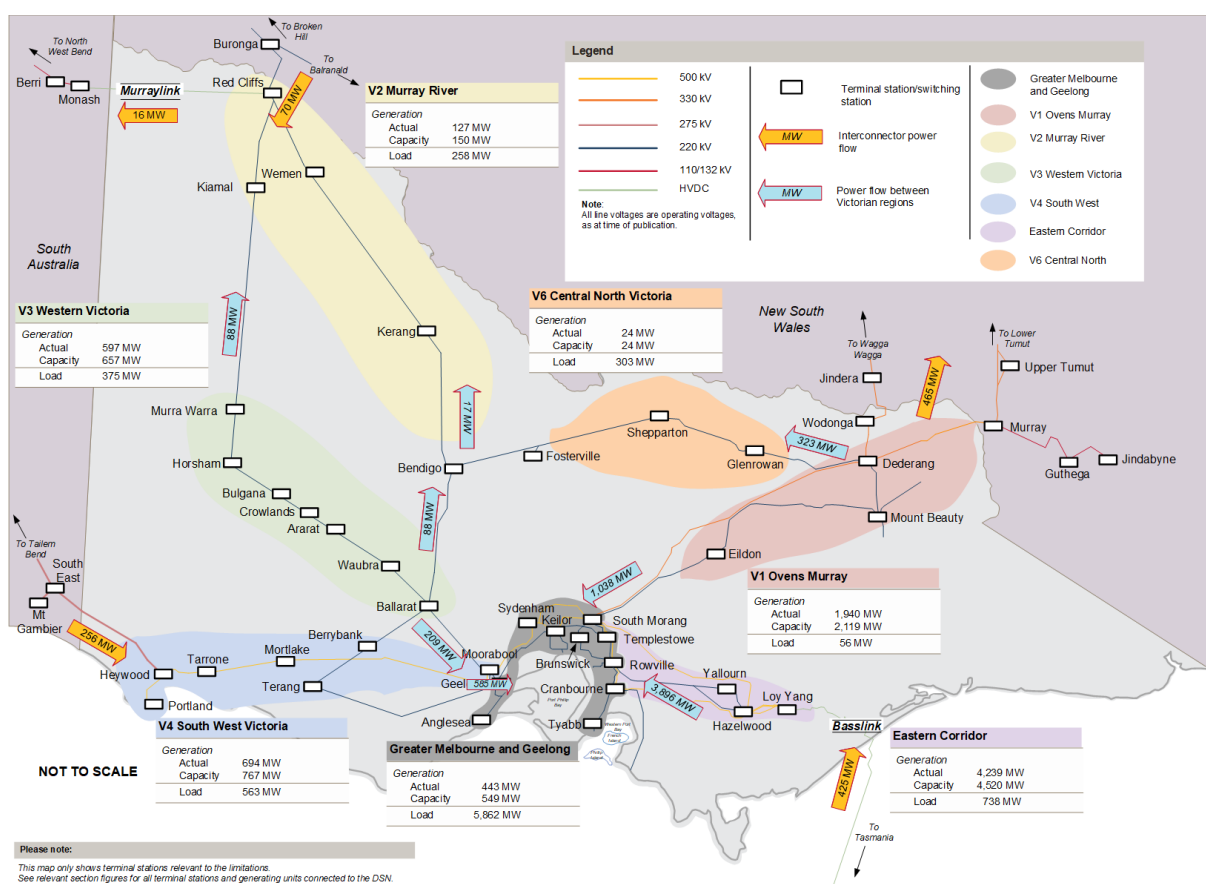

Distributed PV impacts on maximum demand

At the time of maximum demand in Victoria, rooftop PV had an aggregate output of over 600 MW, as illustrated in Figure 13. Without rooftop PV generation, the maximum demand on this day would have occurred earlier at 3:30 pm and would have been 750 MW higher, at 9,167 MW.

Figure 13 Victorian demand profile of maximum demand day (11 January 2021)

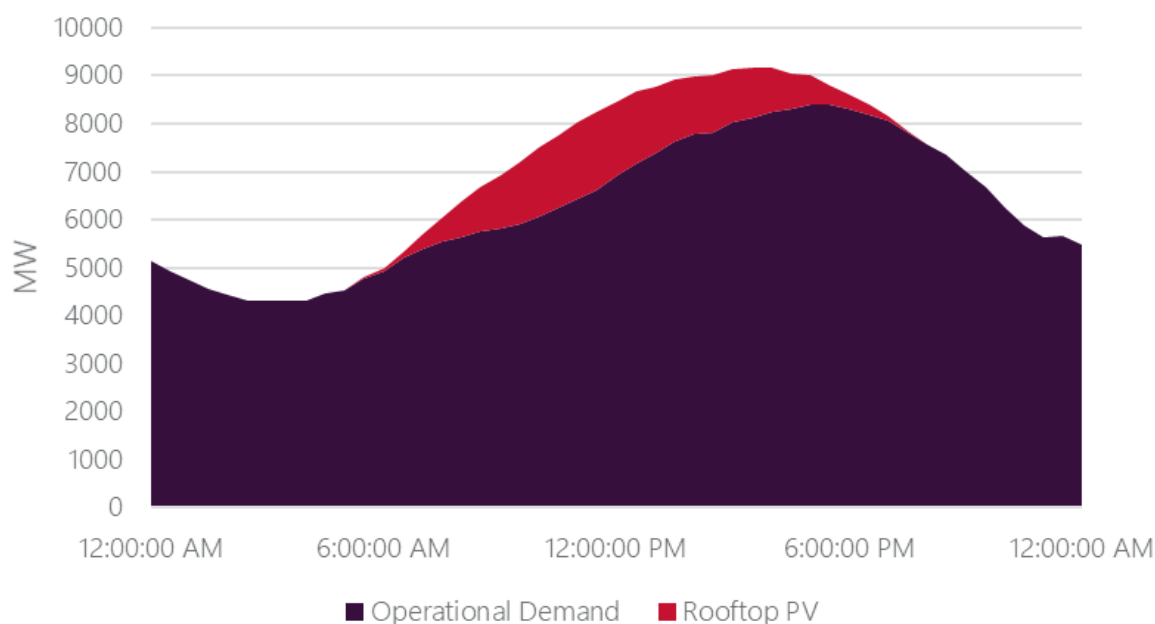

While solar contribution to peak demand is typically helpful, it can also increase the risks associated with ramping and credible contingencies. Weather patterns could cause rapid changes in the location and size of effective demand to be met by the transmission network.

2.8.2 Minimum demand snapshot

The minimum demand snapshot captures conditions under which voltage control may prove challenging as lightly loaded lines charge voltages towards the high end of their operating limits. Table 12 and Figure 14 show the prevailing conditions at the time of minimum demand in Victoria (1.00 pm on 25 December 2020).

Table 12 Minimum demand snapshot – summary of operating conditions

Characteristic	Value (MW)	Notes
Victorian operational demand ^A	2,529	Minimum demand was below the 90% POE minimum demand forecast for the summer period of 3,018 MW ^B . This snapshot reflects a new record for minimum demand for Victoria. Previously, the record had been 3,217 MW, which occurred at 6.00 am on 12 November 2017. This previous record occurred during an unplanned outage at APD, where approximately 380 MW of potline load was offline.
Sum of Victorian loads	2,429	55% (1,331 MW) was concentrated in Greater Melbourne and Geelong.
Sum of Victorian generation	3,665	77% (2,830 MW) of Victorian generation originated from the Eastern Corridor.
Sum of Victorian available generation capacity	5,373	
Net power flow into Victoria via interconnection	-1,156	-879 MW on the VNI (New South Wales). +340 MW on the Heywood Interconnector (South Australia). -146 MW on the Murraylink Interconnector (South Australia). -472 MW on the Basslink Interconnector (Tasmania).
Rooftop PV	1,653	Serving 41% of end user demand.

Characteristic	Value (MW)	Notes
Battery storage	0	All battery storage in Victoria was charging rather than generating in this snapshot with a combined load of 15 MW. There was an additional 35 MW of pumped hydro acting as a load.
Victorian large scale renewable generation	773	Representing 21% of total Victorian generation, and comprising: <ul style="list-style-type: none"> • 105 MW of non-scheduled wind. • 259 MW of dispatched wind. • 409 MW of dispatched solar. • 0 MW of hydroelectric generation.
RERT dispatched	0	
Other system security considerations		Operational measures were applied to maintain voltages within limits, including the de-energisation of a 500 kV line, and activation of an NMAS contract to source additional reactive power from a generating unit. See Section 2.5.2 for details about historical use of operational measures to manage high voltage, and Section 3.3.3 for more detail on AEMO's further investment activities to manage high voltage during low demand periods.

A. Operational demand is the sum of all Victorian loads and network losses.

B. AEMO, 2020 ESOO, at <https://aemo.com.au/en/energy-systems/electricity/national-electricity-market-nem/nem-forecasting-and-planning/forecasting-and-reliability/nem-electricity-statement-of-opportunities-esoo>.

Figure 14 Minimum demand snapshot – generation, load, and interconnector flow

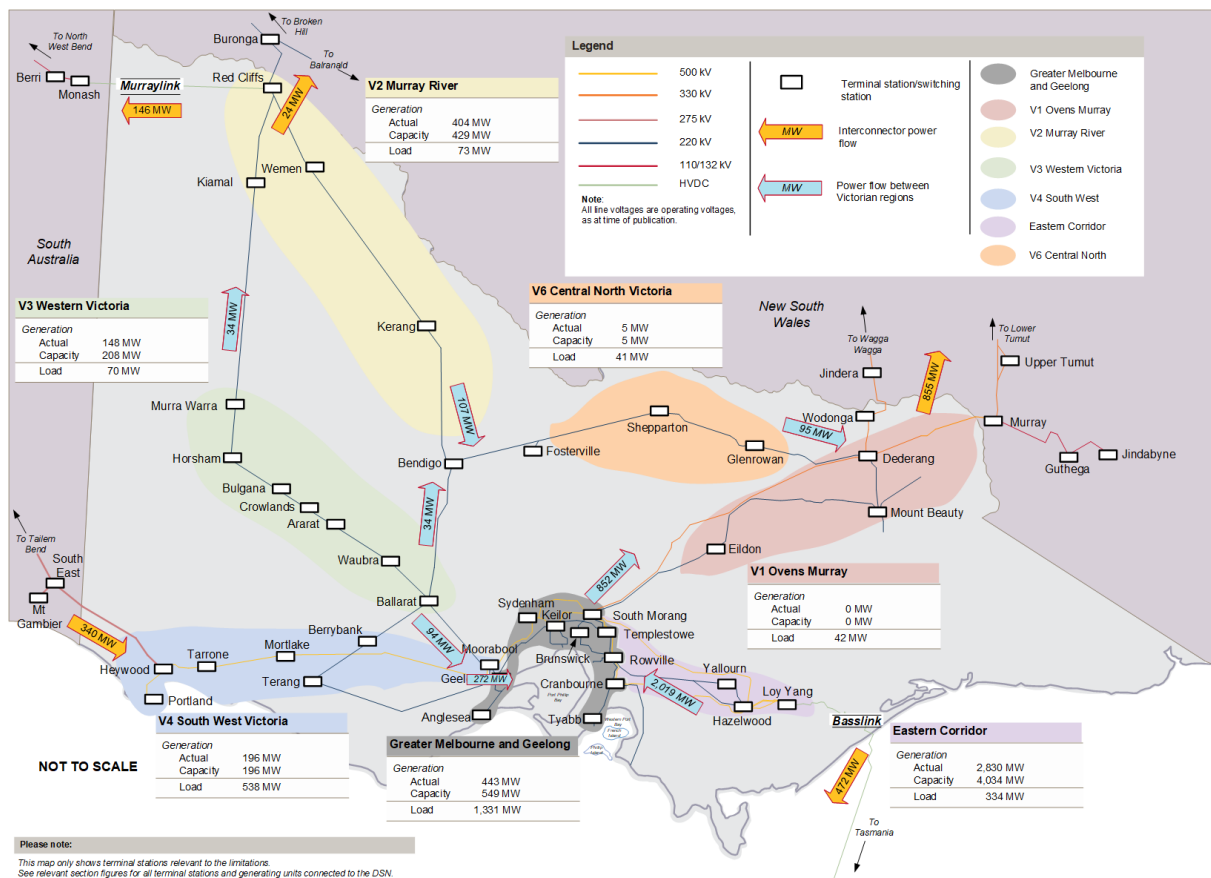

Rooftop PV impacts on minimum demand

Rooftop PV has the greatest impact on operational demand between 8:00 am and 5:00 pm, reducing already low demands in the early afternoon, and smoothing the morning and late afternoon peaks.

Figure 15 shows the impact of rooftop PV generation on the day of annual minimum demand in 2021. At the time of minimum demand, rooftop PV had an aggregate output of over 1,650 MW. Without the effect of rooftop PV, minimum demand on this day would have occurred at 4:00 am, at 3,593 MW.

Figure 15 Victorian demand profile of minimum demand day (25 December 2020)

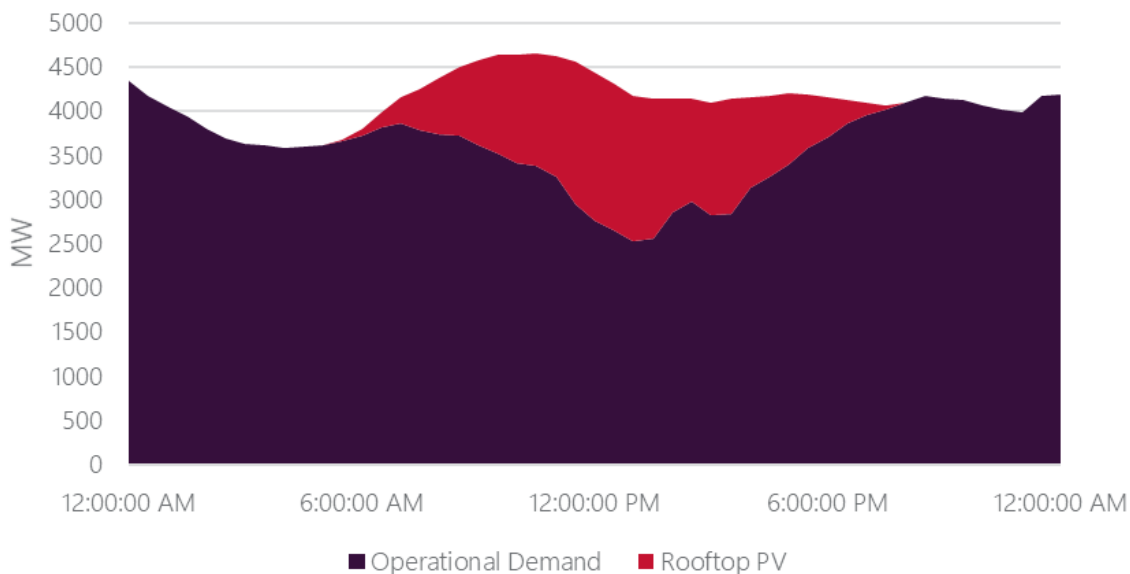

As the capacity of rooftop PV systems increases, minimum demand that has traditionally occurred during the night-time instead occurs during daylight hours while PV generation offsets consumption.

Figure 16 below⁵⁰ shows the number of days each financial year on which minimum demand occurred during daylight hours (8:00 am – 5:00 pm). This occurred on 111 days in 2020-21 compared to 51 days in 2019-20.

Figure 16 Rooftop PV capacity and maximum generation by financial year and number of daytime minimum demand days

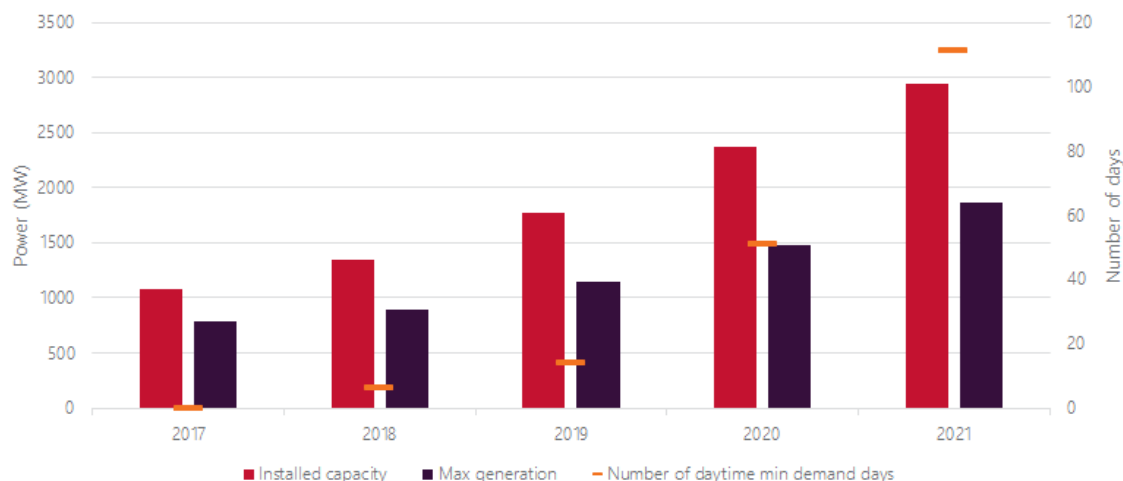

At the start of the 2020-21 financial year, the all-time Victorian minimum demand record was 3,217 MW, set on 12 November 2017 during the night-time. During 2020-21, not only was this record broken, but minimum demand fell below this previous record on 13 different days, all during daylight hours. Throughout 2020-21

⁵⁰ Rooftop PV generation and capacity according to ASEFS 2 measured actuals, see <https://aemo.com.au/en/energy-systems/electricity/national-electricity-market-nem/nem-forecasting-and-planning/operational-forecasting/solar-and-wind-energy-forecasting/australian-solar-energy-forecasting-system>.

the minimum demand record was sequentially broken four times, with demand falling to 3,073 MW in September 2020, then to 3,063 in October 2020, to 2,828 MW in November 2020, and finally to 2,529 MW on the minimum demand snapshot day in December 2020.

These new records represent the first time in Victoria that the all-time minimum demand record has been set during daylight hours due to high rooftop PV generation, and the third consecutive year that the annual minimum demand record has occurred during the day. AEMO'S plans for managing further reductions in minimum demand are discussed in Section 4.5.4.

2.8.3 High wind snapshot

The high wind snapshot captures conditions where Victoria experiences high output from scheduled wind generating units located along the 220 kV North-Western Victorian network between Red Cliffs and Ballarat. This captures times at which this part of the network is under high stress as large flows cause thermal and voltage stability limits to be approached. Table 13 and Figure 17 show the prevailing conditions at the time of high wind generation output in Victoria (5pm on 7 June 2021).

The highest wind generation occurs at times of high wind resource availability coinciding with the time when key limiting conditions are simultaneously minimised, allowing generators to operate unconstrained up to their full output. At the time of this snapshot, no constraints were binding in North West Victoria. Key conditions that allowed for unconstrained generation include:

- Low temperatures (12.4°C at Ballarat) combined with high wind speeds (evidenced by high wind generator outputs) allow the 220 kV to operate at higher thermal ratings due to their cooling effect. The 220 kV network between Red Cliffs and Ballarat operates with dynamic wind-monitored thermal ratings that allow additional thermal capacity under favourable weather conditions in real time.
- The sun setting at the start of the evening reduces solar generation in the 220 kV network in North West Victoria network, reducing congestion and allowing more wind generation. Earlier on the same day, when solar was available (9.00 am and 2.45 pm), thermal constraints in this region continuously bound, resulting in wind generators being constrained.
- Absence of major network outages allows the network to be utilised up to its full capability. As new generators have connected in north-west Victoria in recent years, substantial network outages, typically constraining generation, were not required during this snapshot. Absence of major network outages allowed the network to be utilised up to its full capability. In addition to reducing the thermal capacity of the network and increasing difficulty in maintaining voltage stability, these outages typically lead to system strength issues and are managed via generation constraints (see Section 2.7).

Table 13 High wind snapshot – summary of operating conditions

Characteristic	Value (MW)	Notes
Victorian operational demand ^A	6,304	
Sum of Victorian loads	6,209	68% (4,249 MW) was concentrated in Greater Melbourne and Geelong.
Sum of Victorian generation	7,181	66% (4,716 MW) of Victorian generation originated from the Eastern Corridor.
Sum of Victorian available generation capacity	7,952	
Net power flow into Victoria via interconnection	-727	-741 MW on the VNI (New South Wales). -7 MW on the Heywood Interconnector (South Australia). -58 MW on the Murraylink Interconnector (South Australia). +80 MW on the Basslink Interconnector (Tasmania).

Characteristic	Value (MW)	Notes
Rooftop PV	38	Ramping down as the sun sets
Battery storage	5	
Victorian large scale renewable generation	2,499	Representing 34.8% of total Victorian generation, and comprising: <ul style="list-style-type: none"> 421 MW of non-scheduled wind. 2,061 MW of dispatched wind. 7 MW of dispatched solar. 10 MW of hydroelectric generation. <p>Total wind generation includes 899 MW from the Western Victoria REZ, 1,488 MW from the South-West REZ, and 95 MW from the rest of the state.</p>
RERT dispatched	0	
Other system security considerations	System normal. No contingency overloads. All flows within thermal limits.	

A. Operational demand is the sum of all Victorian loads and network losses.

Figure 17 High wind snapshot – generation, load, and interconnector flow

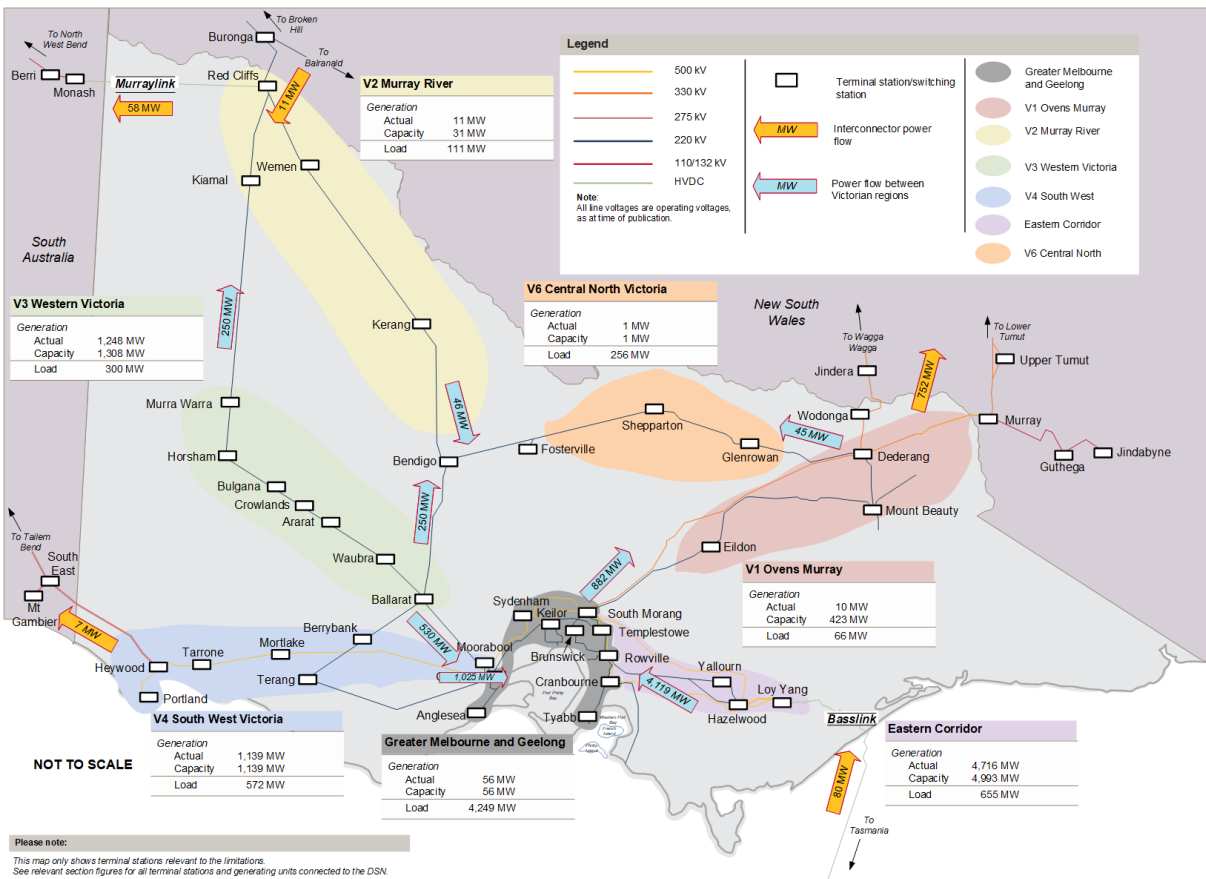

2.8.4 High export snapshot

The high export snapshot captures conditions where Victoria is supplying a high level of power flow into New South Wales. Historically, high exports to New South Wales coincide with high flows along the Dederang to South Morang 330 kV lines, fed primarily through the South Morang F2 330/500kV transformer from the

500 kV network. Table 14 and Figure 18 show the prevailing conditions at a time of high export from Victoria to New South Wales (5.00 pm on 14 June 2021).

Table 14 High export snapshot – summary of operating conditions

Characteristic	Value (MW)	Notes
Victorian operational demand ^A	5,757	
Sum of Victorian loads	5,814	66% (3,819 MW) was concentrated in Greater Melbourne and Geelong.
Sum of Victorian generation	6,792	59% (4,027) of Victorian generation originated from the Eastern Corridor.
Sum of Victorian available generation capacity	7,382	
Net power flow into Victoria via interconnection	-841	-1,222 MW on the VNI (New South Wales). +55 MW on the Heywood Interconnector (South Australia). -28 MW on the Murraylink Interconnector (South Australia). +354 MW on the Basslink Interconnector (Tasmania).
Rooftop PV	36	Ramping down as the sun sets
Battery storage	8	
Victorian large scale renewable generation	1,561	Representing 30.6% of total Victorian generation, and comprising: <ul style="list-style-type: none"> • 67 MW of non-scheduled wind. • 398 MW of dispatched wind. • 5 MW of dispatched solar. • 1,091 MW of hydroelectric generation.
RERT dispatched	0	
Other system security considerations	System normal. No contingency overloads. All flows within thermal limits.	

A. Operational demand is the sum of all Victorian loads and network losses.

Figure 18 High export snapshot – generation, load, and interconnector flow

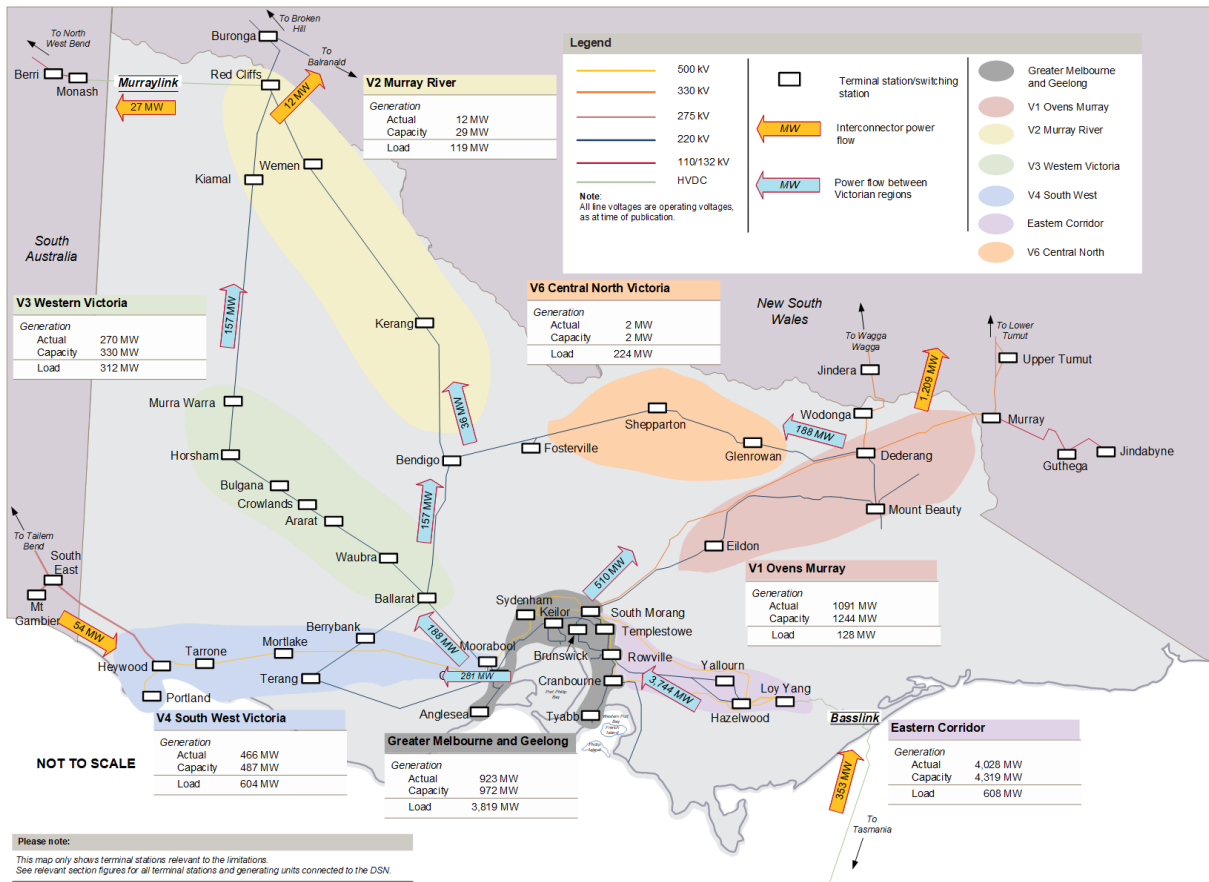

2.8.5 High solar snapshot

The high solar snapshot captures conditions where Victoria experiences high output from solar generating units in north-west Victoria, particularly between Red Cliffs and Bendigo. This represents periods where the 220 kV network may be approach thermal and voltage stability limits.

At the time of this snapshot, the voltage stability constraint V[^]V_NIL_KGTS_2 was binding with marginal value of \$750. This constraint ensures that post-contingent flow from Wemen to Kerang remains below the dynamic threshold to avoid voltage collapse. Table 15 and Figure 19 show the prevailing conditions at a time of high solar generation in Victoria (12.30 pm on 30 March 2021).

Table 15 High solar snapshot – summary of operating conditions

Characteristic	Value (MW)	Notes
Victorian operational demand ^A	4,023	
Sum of Victorian loads	3,865	66% (2,559 MW) was concentrated in Greater Melbourne and Geelong.
Sum of Victorian generation	4,575	80% (3,666 MW) of Victorian generation originated from the Eastern Corridor.
Sum of Victorian available generation capacity	5,564	
Net power flow into Victoria via interconnection	-615	+11 MW on the VNI (New South Wales). -22 MW on the Heywood Interconnector (South Australia).

Characteristic	Value (MW)	Notes
		-150 MW on the Murraylink Interconnector (South Australia). -454 MW on the Basslink Interconnector (Tasmania).
Rooftop PV	1,640	Serving 30% of end user demand
Battery storage	1	
Victorian large scale renewable generation	913	Representing 20% of total Victorian generation, and comprising: <ul style="list-style-type: none"> • 89 MW of non-scheduled wind. • 236 MW of dispatched wind. • 588 MW of dispatched solar.
RERT dispatched	0	
Other system security considerations	System normal. No contingency overloads. All flows within thermal limits.	

A. Operational demand is the sum of all Victorian loads and network losses.

Figure 19 High solar snapshot – generation, load, and interconnector flow

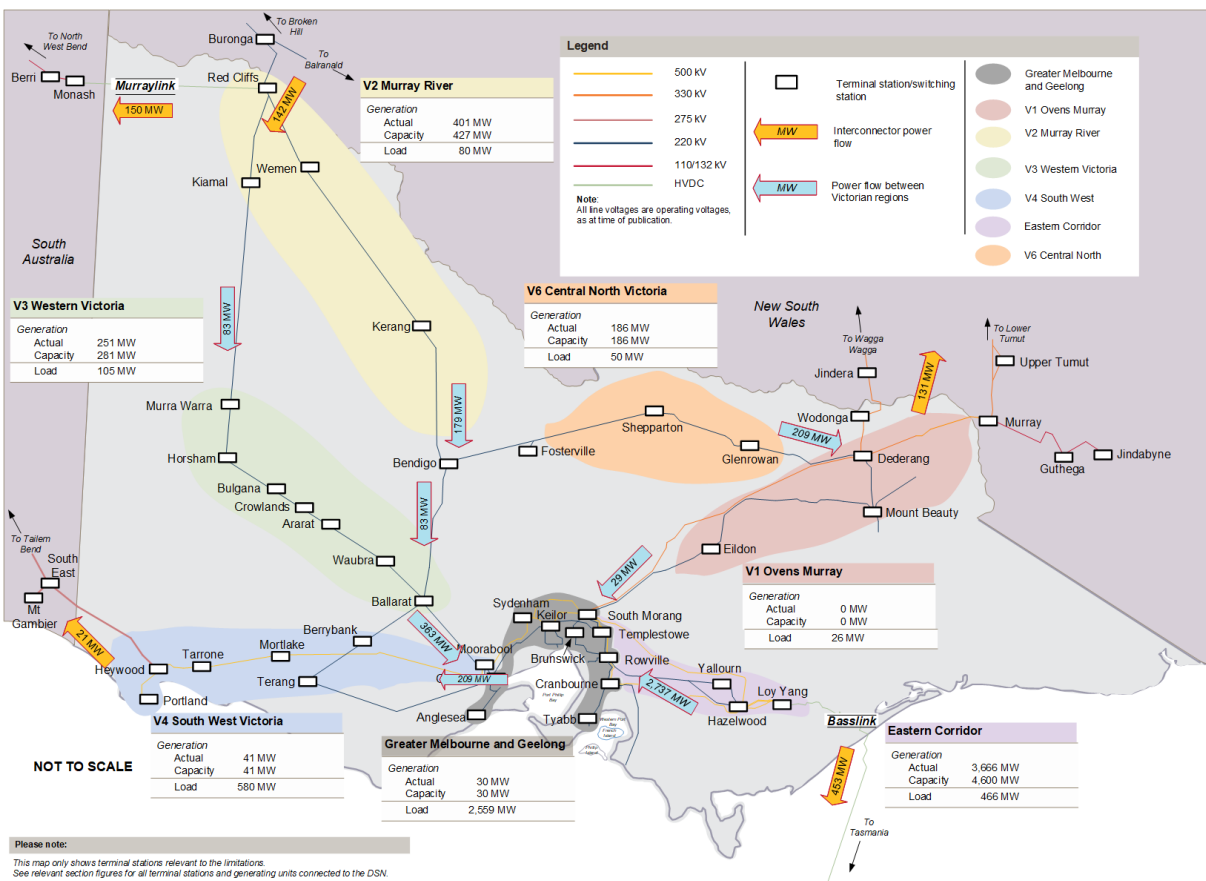

3. Network developments

This chapter provides an update on the network investment activities and investigations that have progressed since October 2020, and which will facilitate the integration of new renewable generation while supporting Victorian power system security and reliability.

Key network development insights

Victoria's rapid energy transition is being driven by large-scale renewable energy generation connecting in the west of the state, and the aggressive uptake of distributed generation by consumers. Since the 2020 VAPR, 472 MW of large-scale renewable projects have connected⁵¹ in Victoria, 503 MW of large-scale renewable projects is committed to connect, and 26.5 GW of additional wind, solar and storage is proposed to connect. Victoria now has approximately 3.1 GW⁵² of rooftop PV installed.

These new supply sources are increasingly displacing traditional generation in the Latrobe Valley. This is altering network power flows and causing increased network congestion. Increasing levels of instantaneous penetration of non-synchronous and distributed energy sources are creating complex operational challenges, such as maintaining power system stability, managing network voltages, and adapting to reverse power flows (see Section 2.5.3).

To meet the forecast future needs of the system, AEMO is progressing a suite of projects across the state through its *Transmission Development Plan for Victoria*. This plan aligns with the ISP and is designed to deliver security and reliability objectives in the context of Victorian Government policy and regulatory settings. These investments act to reduce overall costs to consumers by unlocking lower-cost generation supplies, enhancing competition, and improving the efficiency of resource sharing between neighbouring regions.

Together these projects target key thermal, stability, voltage control, system strength, and REZ expansion limits across the state.

Delivered and committed projects

- REZ expansion: Western Victoria and Murray River:
 - Following completion of the Western Victoria RIT-T in July 2019, the Western Victoria Transmission Network Project is expected to be delivered by 2025 to unlock renewables resources in the Western Victoria REZ.
 - The associated minor augmentations in west and north-west Victoria were delivered in 2021 through AusNet Services' NCIPAP.
 - Modifications are being made to the Murraylink Very Fast Runback Scheme to adapt to changes in network conditions in the west and north-west of Victoria, and offer minor reductions in thermal limitations in the area by Q1 2022.

⁵¹ Either in full service or undergoing commissioning tests.

⁵² The number was obtained from AEMO's DER Register September 2021, at <https://aemo.com.au/en/energy-systems/electricity/der-register>. The DER Register was not in place for the 2020 VAPR, and this year's number has been recalibrated.

- Interconnection:
 - At the request of the Victorian Government, AEMO has procured a System Integrity Protection Scheme (SIPS) that will increase import capabilities of the VNI by up to 250 MW from November to March each year. The scheme is expected to be in service by summer 2021-22.
 - Following completion of the VNI Upgrade RIT-T, AEMO and TransGrid are jointly delivering upgrades to increase the VNI export capability by up to 170 MW by summer 2022-23.
 - Following the completion of the South Australia Energy Transformation RIT-T, TransGrid and ElectraNet are progressing the delivery of Project EnergyConnect (PEC), a new interconnector between South Australia and New South Wales via Red Cliffs in north-west Victoria⁵³. The project is expected to be completed by late 2024.
 - In September 2021, AusNet Services installed series compensation on the WOTS-JIND 330 kV line which will allow a minor increase in VNI capacity under contingency conditions.
- Voltage control – following completion of the Victorian Reactive Power Support RIT-T, three new 100 MVar reactors are being delivered in Victoria to support network voltages during low demand conditions by Q2 2022. This project is in addition to the reactor delivered at Keilor in 2021 under AusNet Services' NCIPAP process.

Proposed future projects

- Interconnection and REZ expansion – AEMO and TransGrid are jointly progressing the VNI West RIT-T, to deliver additional transfer capacity between Victoria and New South Wales. This project aims to improve supply reliability, yield more efficient development and dispatch of high-quality renewable resources, and allow more efficient sharing of resources between NEM regions.
- Interconnection – TasNetworks has published a Project Assessment Conclusions Report (PACR)⁵⁴ to deliver MarinusLink, a new 1,500 MW high voltage direct current (HVDC) cable between Tasmania and Victoria, and associated works.
- Voltage control – AEMO's 2021 ESOO forecasts the rapid decline in minimum demand continuing, and negative demand as early as 2025⁵⁵. AEMO is undertaking pre-feasibility investigations to assess the need for further reactive power capability with the intention of commencing a RIT-T in 2022, subject to the outcome of these investigations.

REZ Development Plan (RDP) projects:

By Ministerial Order under the NEVA⁵⁶, the Victorian Government has directed AEMO to progress procurement activities for six sets of potential near-term projects (Stage 1) to support renewable development in Victorian REZs.

3.1 Supply changes since the 2020 VAPR

This section reviews the completed and committed changes to Victoria's fleet of generation and storage projects since publication of the 2020 VAPR. The scale and type of these projects highlight the changing nature of the Victorian DSN, and are the key drivers for network projects discussed later in this chapter. The changes also underpin the changes of network limitations, which are discussed in Chapter 4.

⁵³ TransGrid and ElectraNet – Project EnergyConnect contingent project, Australian Energy Regulator (AER) Final Decision May 2021, at <https://www.aer.gov.au/networks-pipelines/determinations-access-arrangements/contingent-projects/transgrid-and-electranet-%E2%80%93-project-energyconnect-contingent-project/final-decision>.

⁵⁴ See <https://www.marinuslink.com.au/wp-content/uploads/2021/06/Project-Marinus-RIT-T-PACR.pdf>.

⁵⁵ See <https://aemo.com.au/en/energy-systems/electricity/national-electricity-market-nem/nem-forecasting-and-planning/forecasting-and-reliability/nem-electricity-statement-of-opportunities-esoo>.

⁵⁶ See <http://www.gazette.vic.gov.au/gazette/Gazettes2021/GG2021S417.pdf>.

Information on existing, committed and potential generation projects is from AEMO's generation information page⁵⁷. AEMO's website also contains a register of large generator connection projects⁵⁸.

3.1.1 Newly connected projects

The following 472 MW of large (greater than 30 MW) generator projects finished commissioning since the 2020 VAPR:

- Berrybank Wind Farm (180.6 MW) connected to Berrybank Terminal Station.
- Bulgana Wind Farm Stage 1 (100 MW) connected at Bulgana Terminal Station.
- Elaine Wind Farm (82 MW) connected to Elaine Terminal Station.
- Glenrowan West Sun Farm (110 MW) via Ausnet Services' network at Glenrowan Terminal Station.

The following 733 MW of large generator projects have commenced commissioning since the 2020 VAPR:

- Bulgana Wind Farm Stage 2 (104 MW) connected at Bulgana Terminal Station.
- Cohuna Solar Farm (27 MW) via Powercor's network at Kerang Terminal Station
- Moorabool Wind Farm Stage 1 (150 MW) connected to Elaine Terminal Station in November 2020.
- Stockyard Hill Wind Farm Stage 1 (286 MW) connected to Haunted Gully Terminal Station.
- Winton Solar Farm (85 MW) connected via Ausnet Services' network at Glenrowan Terminal Station.
- Yatpool Solar Farm (81 MW) via Powercor's network at Red Cliffs Terminal Station.

One generator upgrade has been completed since the 2020 VAPR, at Loy Yang B1, allowing an additional 60 MW of generation capacity.

3.1.2 Newly committed projects

Since the 2020 VAPR, the following generation projects have become committed, meaning they have secured land and planning approvals, entered into contracts for finance, and have either started construction or have set a firm date:

- Murra Warra Wind Farm - Stage 2 (203.5 MW) – DSN connected.
- Victorian Big Battery (300 MW) – DSN (Moorabool) connected.

EnergyAustralia has publicly announced the development of the Jeeralang battery (350 MW) as part of an agreement with the Victorian Government for the delivery of an orderly YPS shutdown. The project does not yet meet AEMO's commitment criteria.

3.1.3 Retirement projects

Since the 2020 VAPR, the retirement of YPS (all units) has been announced for mid-2028. The impact of the retirement is further discussed in Section 4.6.

3.1.4 Terminal station developments to support new connections

There has been no new terminal station development since the publication of the 2020 VAPR.

⁵⁷ See AEMO, Generation Information webpage, Victoria update October 2021 <https://aemo.com.au/energy-systems/electricity/national-electricity-market-nem/nem-forecasting-and-planning/forecasting-and-planning-data/generation-information>. AEMO's commitment criteria are under the Background Information tab.

⁵⁸ At <http://www.aemo.com.au/Electricity/National-Electricity-Market-NEM/Planning-and-forecasting/Victorian-transmission-network-service-provider-role/Register-of-Large-Generator-Connections>.

3.2 Renewable energy investment

Victoria continues to attract strong interest in new renewable generation projects, driving the rapidly changing operational landscape. The total renewable generation installed capacity in Victoria is 8.7 GW (inclusive of hydro generation) which accounts for 54% of the total installed generation capacity of 16 GW. The state now has approximately 8.2 GW of existing or committed wind and solar generation, of which 3.1 GW⁵⁹ (38%) is attributed to distributed PV installations. There is also 2.3 GW of existing hydro generation, and 375 MW of existing or committed battery storage⁶⁰.

Since publication of the 2020 VAPR, 472 MW of large-scale renewable projects have connected, and 733 MW has commenced commissioning in Victoria. There are a further 503 MW of renewable projects committed to connect.

A further 26.5 GW of additional wind, solar and storage projects have proposed to connect.

Figure 20 summarises Victoria’s existing, committed, and proposed generation projects⁶¹.

Figure 20 Existing, committed and proposed large-scale generation capacity in Victoria, October 2021

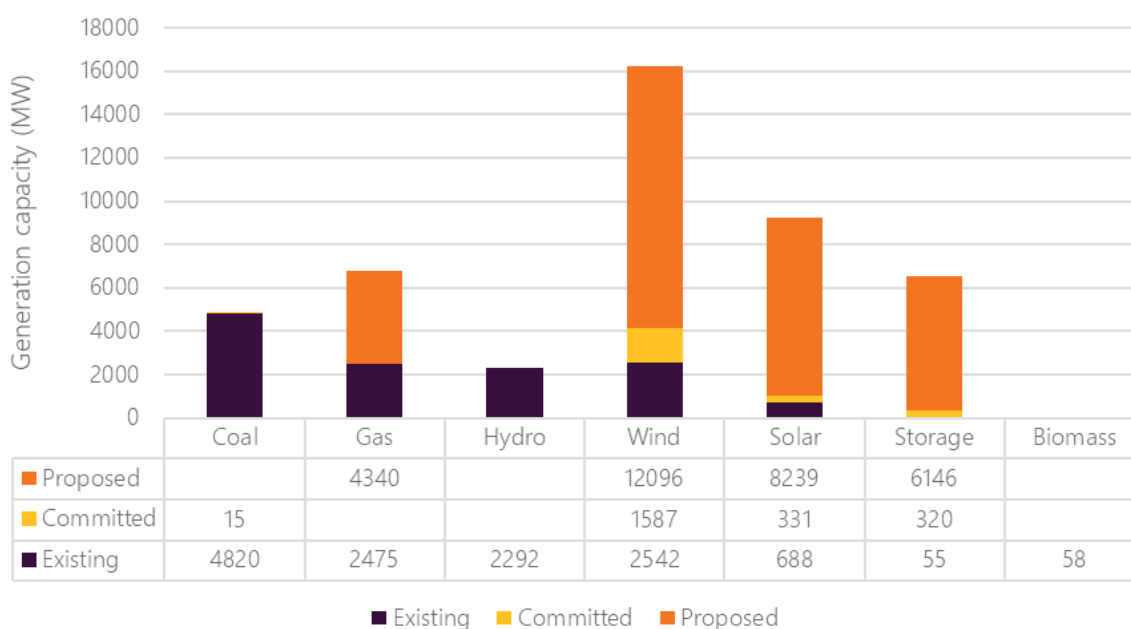

Note: Committed includes those projects that are currently undergoing the commissioning process.

The Victorian Government’s VRET, which seeks to deliver 40% renewable energy generation by 2025 and 50% by 2030⁶², continues to attract investors. The recently announced 600 MW VRET2 auction⁶³ is expected to further encourage generation to connect to the Victorian DSN.

As reported in the 2020 ISP, at least 13.2 GW in renewable generation would be required to deliver the VRET under the Central scenario when using the latest demand forecasts (see Figure 21). This represents up to 5 GW of additional renewable investment, spread between large-scale and distributed resources.

⁵⁹ The number was obtained from AEMO’s DER Register September 2021, at <https://aemo.com.au/en/energy-systems/electricity/der-register>. The DER Register was not in place for the 2020 VAPR, and this year’s number has been recalibrated.

⁶⁰ See <http://www.aemo.com.au/Electricity/National-Electricity-Market-NEM/Planning-and-forecasting/Generation-information>.

⁶¹ See <http://www.aemo.com.au/Electricity/National-Electricity-Market-NEM/Planning-and-forecasting/Generation-information>.

⁶² See <https://www.energy.vic.gov.au/renewable-energy/victorias-renewable-energy-targets>.

⁶³ See <https://www.energy.vic.gov.au/renewable-energy/vret2>.

Figure 21 Renewable development in the ISP Central (updated demand) scenario by 2029-30



3.3 Transmission Development Plan for Victoria

To address the emerging operational issues highlighted in Section 2.5 and Section 2.7, and to deliver a system capable of facilitating the supply changes identified in Section 3.2, AEMO is progressing a suite of projects across the state through its *Transmission Development Plan for Victoria*.

The projects will facilitate the connection of new generation, increase network capacity to transfer power between new supply centres and demand, and manage emerging operational challenges before they arise. It has been designed to efficiently deliver system security requirements, maintain supply reliability, and minimise overall costs to consumers in the context of Victorian Government policy and regulatory settings.

This section presents projects across four categories:

- **Delivered projects** – projects completed since publication of the 2020 VAPR.
- **Committed projects** – focusing on near-term upgrades that have already passed appropriate regulatory approvals, and comprising six initiatives that target key thermal, stability, voltage control, system strength, and REZ expansion projects across the state.
- **Future projects** – focusing on mid- and long-term projects that are currently progressing through design and regulatory testing processes. These include all relevant projects identified as part of the 2020 ISP optimal development path.
- **Priority limitations** – focusing on short-term projects as requested by the Victorian Government that are currently progressing through design and procurement processes.

Figure 22 and Figure 23 summarise AEMO’s 2020 *Transmission Development Plan for Victoria*. The rest of this chapter provides further details about each project.

Figure 22 Transmission development plan – delivered and committed projects

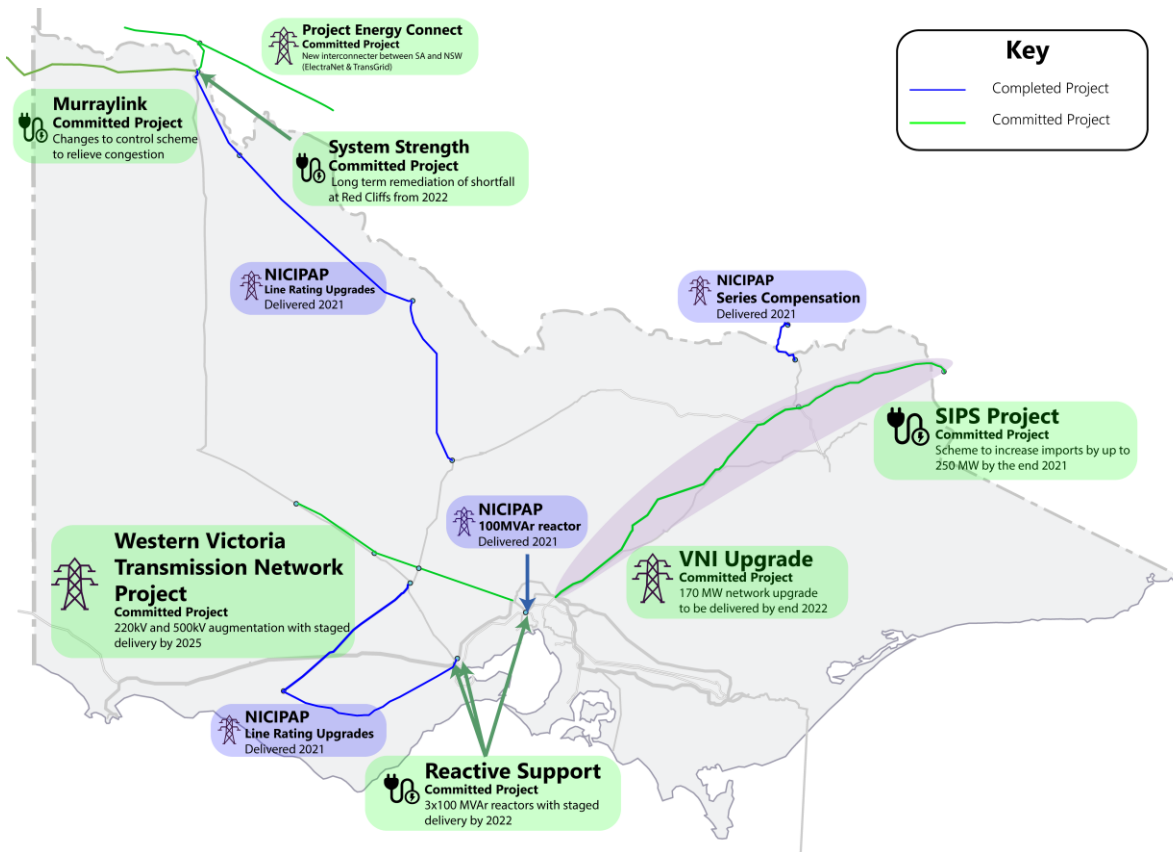
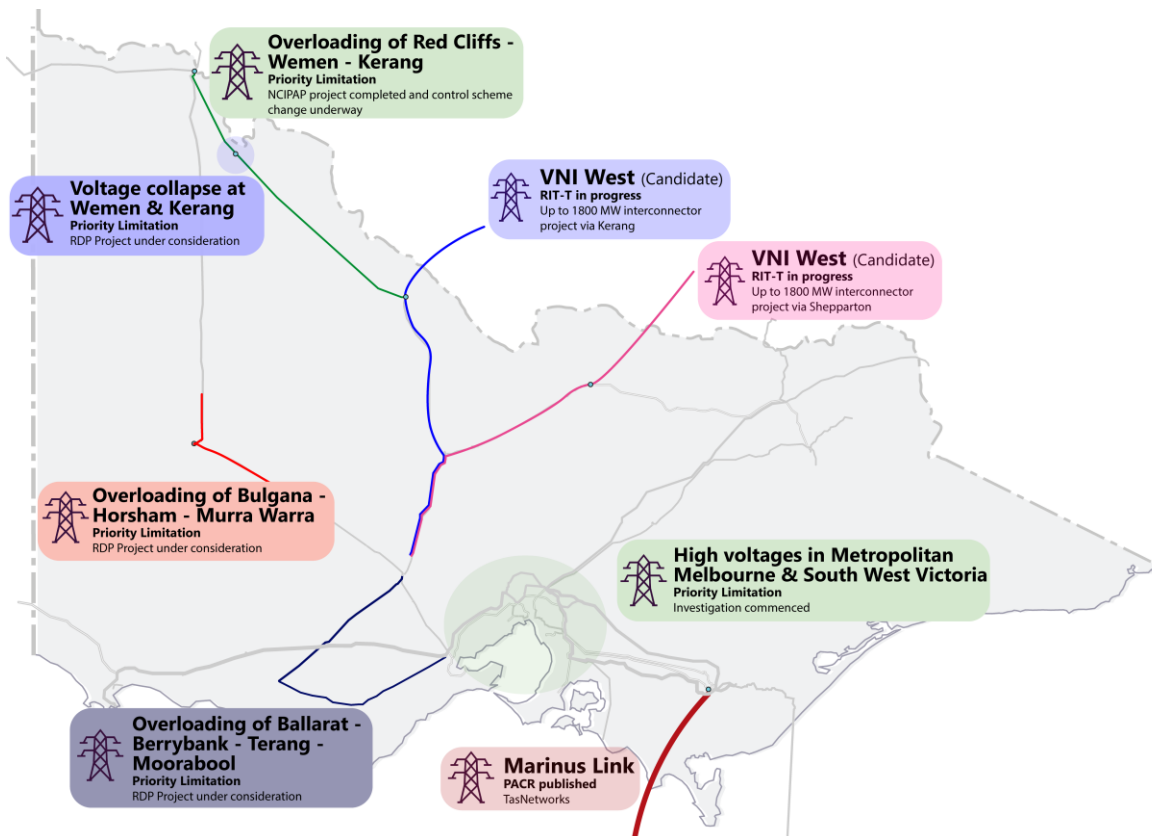

Figure 23 Transmission development plan – future projects and priority limitations



3.3.1 Delivered projects

The following projects have already been completed since publication of the 2020 VAPR:

- Associated with Western Victoria Renewable Integration RIT-T, AusNet NCIPAP project to upgrade the Ballarat – Berrybank – Terang - Moorabool 220 kV line to increase its thermal rating, including the ability for wind monitoring to input into dynamic ratings, was completed in November 2020. The rating was increased from 438 megavolt-amperes (MVA) to 495 MVA for the Ballarat – Berrybank – Terang section and from 324 MVA to 335 MVA for the Terang – Moorabool section.
- Associated with Western Victoria Renewable Integration RIT-T, AusNet NCIPAP project to upgrade the Red Cliffs – Wemen – Kerang - Bendigo 220 kV line to increase its thermal rating, including the ability for wind monitoring to input into dynamic ratings, was completed in August 2021. The rating was increased from 285 MVA to 304 MVA for the Red Cliffs – Wemen – Kerang section and from 328 MVA to 432 MVA for the Kerang – Bendigo section.
- AusNet NCIPAP project to install 100 MVar reactor at KTS to assist in managing high voltages was completed in April 2021.
- AusNet NCIPAP project to install series compensation equipment on the Wodonga – Jindera 330 kV line to allow higher Victoria – New South Wales interconnector flow was completed in June 2021.

3.3.2 Committed project: Western Victoria Renewable Integration RIT-T

The Western Victoria region is experiencing significant renewable generation development, with large amounts of additional generation expected to be operational in the near future. However, transmission infrastructure in this region is insufficient to allow efficient access to all generation seeking to connect.

In July 2019, AEMO completed a RIT-T to unlock renewable energy resources, reduce network congestion, and improve utilisation of existing assets in western parts of Victoria⁶⁴. In December 2019, AusNet Services was awarded a contract to consult on design and seek planning approvals to build, own, operate and maintain the preferred transmission augmentations identified by the RIT-T.

The Western Victoria Transmission Network Project consists of:

- A new 500/220 kV terminal station north of Ballarat with two new 1,000 MVA 500/220 kV transformers.
- A new 220 kV double circuit transmission lines from Bulgana Terminal Station to Waubra Terminal Station to the new terminal station north of Ballarat.
- New 500 kV double circuit transmission lines from Sydenham to a new terminal station north of Ballarat.

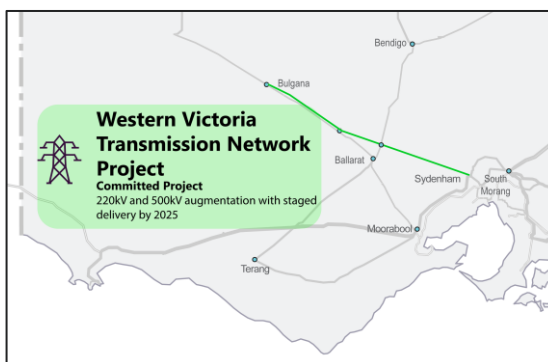

Locations represented on the map are network schematics, have been provided for illustrative purposes only, and are subject to change.

AusNet Services is progressing planning and environmental investigations within the project's selected corridor and is currently engaging with identified landowners and key representatives of the community. The

⁶⁴ See https://www.aemo.com.au/-/media/Files/Electricity/NEM/Planning_and_Forecasting/Victorian_Transmission/2019/PACR/Western-Victoria-RIT-T-PACR.pdf.

latest project information is available on AusNet Services' dedicated project website⁶⁵. This contestable project is currently estimated to be delivered by Q4 2025.

The associated minor non-contestable transmission line augmentations – including wind monitoring and upgrading station limiting transmission plant – for the Red Cliffs to Wemen to Kerang to Bendigo and Moorabool to Terang to Ballarat 220 kV transmission lines has been delivered via AusNet Services NCIPAP.

3.3.3 Committed project: Victorian Reactive Power Support RIT-T

Under minimum demand conditions, and without operator intervention, high voltages can occur on the Victorian transmission network. Short-term operational measures have become necessary to maintain voltages within operational limits, which are resulting in higher market costs, reduced system resilience, and higher system security risks. Section 2.5.2 discusses the need and frequency of these interventions further.

In December 2019, AEMO completed a RIT-T to deliver additional reactive support to maintain voltages during minimum demand periods in Victoria⁶⁶.

The Victorian Reactive Power Support Project consists of:

- One additional 220 kV 100 MVar shunt reactor at Keilor Terminal Station.
- Two additional 220 kV 100 MVar shunt reactors at Moorabool Terminal Station.

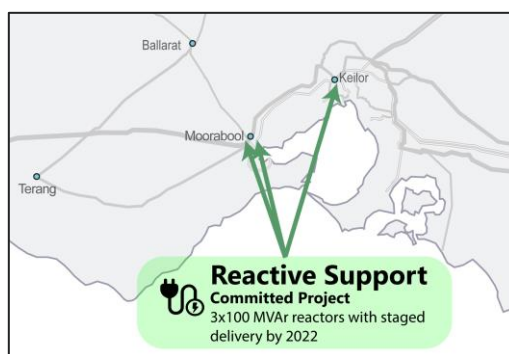

AEMO has engaged AusNet Services to procure, own, operate and maintain the equipment identified by the RIT-T. The second 220 kV 100 MVar reactor at Keilor Terminal Station is expected to be commissioned in December 2021. The two 220 kV 100 MVar shunt reactors at Moorabool Terminal Station are expected to be in service by Q3 2022. This project is non-contestable.

The AER-approved installation of the first 220 kV 100 MVar reactor at KTS, which was part of an AusNet Services NCIPAP process, was commissioned in April 2021.

3.3.4 Committed project: VNI Upgrade RIT-T

Power transfers from Victoria to New South Wales are currently restricted by thermal, voltage stability, and transient stability limitations (see Section 2.4). Resolving these limitations will allow more efficient sharing of resources between regions, and improve supply adequacy following the Liddell Power Station retirement in 2022-23.

In February 2020, AEMO and TransGrid completed a RIT-T⁶⁷ that assessed network and non-network options to address the transfer capacity of the existing VNI.

⁶⁵ See <https://www.westvictnp.com.au/>.

⁶⁶ AEMO, Victorian Reactive Power Support, December 2019, at https://aemo.com.au/-/media/files/electricity/nem/planning_and_forecasting/victorian_transmission/2019/reactive-power-rit-t/victorian-reactive-power-support-pacr.pdf.

⁶⁷ See https://www.aemo.com.au/-/media/files/electricity/nem/planning_and_forecasting/victorian_transmission/2020/vni-rit-t/victoria-to-new-south-wales-interconnector-upgrade-rit-t-pacr.pdf?la=en&hash=0564037FF5BFD025B8A8E7EA3CBD9743.

The VNI Upgrade project consists of the following augmentations:

- Installation of a second 500/330 kV transformer at South Morang Terminal Station.
- Re-tensioning of the 330 kV South Morang – Dederang transmission lines, as well as associated works (including replacement of series capacitors), to allow operation at thermal rating.
- Installation of modular power flow controllers on the 330 kV Upper Tumut to Canberra and Upper Tumut to Yass lines to balance power flows. This work will be undertaken by TransGrid in New South Wales.

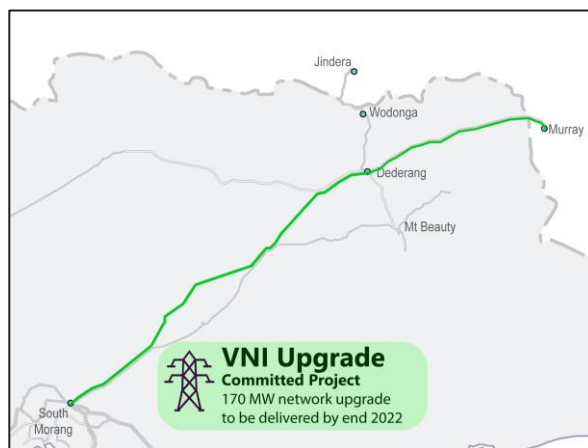

AusNet Services commenced the Victorian components of the project in July 2020, the design phase has been completed, and procurement and construction is underway.

TransGrid has received regulatory approvals to commence works for installation of modular power flow controllers in New South Wales.

The non-contestable project remains on track for completion by late 2022.

3.3.5 Committed project: Red Cliffs System Strength Remediation Project

On 13 December 2019, AEMO published a notice of fault level shortfall⁶⁸ at Red Cliffs Terminal Station under clause 5.20C.2(c) of the NER. AEMO further revised this shortfall on 6 August 2020 due to updated modelling and data inputs that more accurately reflect power system operations at Red Cliffs⁶⁹ and Victoria.

The revised notice specified an immediate fault level shortfall (also referred to as a system strength gap) of at least 66 MVA, which would continue beyond 2024-25 if not addressed.

As the System Strength Service Provider for Victoria, AEMO is responsible for procuring services to address this declared shortfall. Under the NER, remediation of a declared system strength gap does not require a RIT-T process where that gap is forecast to occur within 18 months. In such cases, the System Strength Service Provider (AEMO in this case) must use reasonable endeavours to remediate the gap.

AEMO has progressed remediation activities in two stages:

- An initial (two-year) solution targeting interim services from providers with known capability to provide system strength services under an NMAS agreement.
- A parallel expression of interest and tender process seeking a long-term solution, which may include a combination of network and non-network investments.

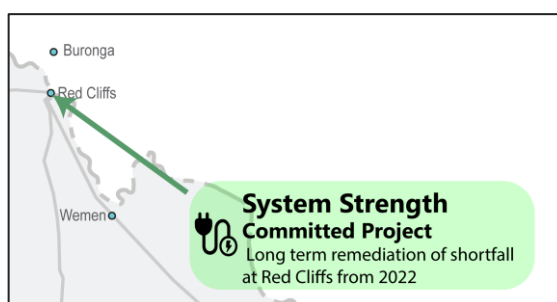

⁶⁸ See https://aemo.com.au/-/media/files/electricity/nem/security_and_reliability/system-security-market-frameworks-review/2019/notice_of_victorian_fault_level_shortfall_at_red_cliffs.pdf.

⁶⁹ See https://aemo.com.au/-/media/files/electricity/nem/security_and_reliability/system-security-market-frameworks-review/2020/notice-of-change-to-red-cliffs-220kv-minimum-fault-level-requirement-and-shortfall.pdf.

In August 2020, AEMO secured interim services from two facilities in the West Murray region under fixed-term contracts for at least two years. These services address the declared gap for that period.

In September 2020, AEMO published a call for expressions of interest to procure a longer-term solution⁷⁰ which aims to be in service by 31 July 2022, but no later than 31 July 2023. The successful providers may be located at one or multiple locations in north-west Victoria and south-west New South Wales. AEMO is currently evaluating short-listed providers and is seeking to complete the tender process in due course.

3.3.6 Committed project: System Integrity Protection Scheme (SIPS) 2020

The Victorian Parliament has amended the NEVA, allowing priority projects to be fast-tracked to deliver augmentation projects, or non-network services with respect to the DSN⁷¹.

Under this amendment, the Minister for Energy, Environment and Climate Change has new powers to modify or disapply sections of the NEL and the National Electricity Rules (NER) as they relate to specified augmentations, specified augmentation services, or specified non-network services in respect of the Victorian DSN.

The Victorian Government has used the NEVA legislation to request AEMO to procure a SIPS that will increase VNI import capabilities by up to 250 MW from November to March each year. The SIPS service achieves this by rapidly responding to inject power after a contingency event on VNI. This allows VNI to run to its 5-minute thermal rating, rather than the 15-minute ratings that would typically apply.

In November 2020, AEMO was directed by the Victorian Government to enter into the SIPS Support Agreement (SSA), which was subsequently executed with Victoria Big Battery Ltd (VBB). The Victorian Big Battery is contracted to provide services as part of the VNI SIPS. Construction of the facility commenced in early 2021. Following a fire incident which took place on 30 July 2021, regulatory authorities have reviewed the root cause analysis and the mitigation actions and provided the project with approval to resume energisation in late September. VBB subsequently recommenced testing and commissioning and is working towards delivering the project before the end of 2021. This is a contestable project.

3.3.7 Committed project: Murraylink Very Fast Runback (VFRB) scheme (Vic) Enhancement

AEMO is progressing changes to this scheme based on the recommendation of Victoria control scheme review as outlined in the 2020 VAPR. The scheme will be modified to disarm runback when generation in the area is high for certain contingencies and operating conditions. The scheme will remain armed when beneficial to the system.

This non-contestable project will update the existing VFRB scheme to allow more efficient dispatch of generation in the area and is expected to be completed by early 2022.

3.3.8 Future project: VNI West RIT-T

The 2018 ISP⁷² identified that both short-term and longer-term investments were required to increase interconnection capacity between Victoria and New South Wales. As described in Section 3.3.4, AEMO and TransGrid are already jointly progressing the delivery of a minor VNI upgrade to address immediate needs for increased transfer capacity between Victoria and New South Wales. However, the ISP also identified that a longer-term investment would be required to strengthen bidirectional interconnection between the states.

In December 2019, AEMO and TransGrid jointly published a PSCR, commencing the VNI West RIT-T⁷³.

⁷⁰ See <https://aemo.com.au/en/consultations/tenders/victorian-transmission/call-for-expressions-of-interest-victorian-system-strength>.

⁷¹ See <https://www.legislation.vic.gov.au/as-made/acts/national-electricity-victoria-amendment-act-2020>.

⁷² See <https://aemo.com.au/en/energy-systems/major-publications/integrated-system-plan-isp/2020-integrated-system-plan-isp>.

⁷³ AEMO and TransGrid, VNI West RIT-T Project Specification Consultation Report (PSCR), December 2019, at https://aemo.com.au/-/media/Files/Electricity/NEM/Planning_and_Forecasting/Victorian_Transmission/VNI-West-RIT-T/VNI-West_RIT-T_PSCR.pdf.

In 2020, the VNI West project was identified as an actionable ISP project with decision rules⁷⁴. This augmentation is expected to deliver fuel cost savings, facilitate efficient connection of new renewable generation, and maintain system security and reliability in Victoria. It provides a pathway to access dispatchable capacity⁷⁵ and mitigates risks associated with withdrawal of ageing generators, including YPS which is expected to retire in 2028.

The 2020 ISP⁷⁶ considered a range of credible network options to meet the identified need. Out of this broader set of options, two candidates were identified as delivering the highest net market benefits, as shown below.

VNI West via Shepparton:

- A double circuit 500 kV line from a new substation north of Ballarat to Wagga Wagga, via Shepparton (costing \$2.711 billion).

VNI West via Kerang:

- A double circuit 500 kV line from a new substation north of Ballarat to Wagga Wagga, via Kerang and Dinawan (costing \$4.076 billion).

Locations represented on the map are network schematics, have been provided for illustrative purposes only, and are subject to change.

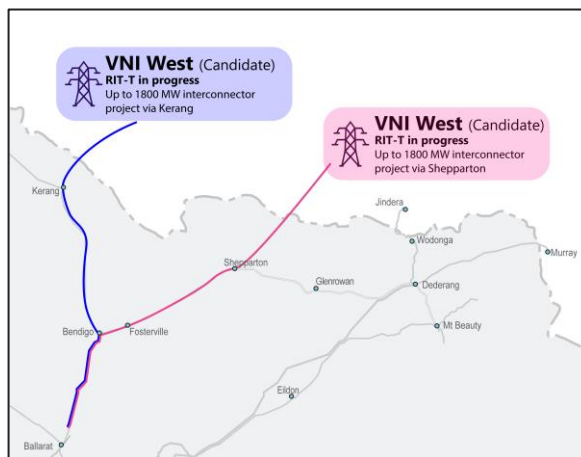

Through the RIT-T, AEMO and TransGrid are assessing the technical and economic viability of credible options under the Actionable ISP framework.

The 2020 ISP identified VNI West as an actionable ISP project with decision rules, which means the project can change if particular circumstances change. Specifically, the decision rules require a change in the project if:

- Transmission costs estimations exceed the benefits identified by the 2020 ISP.
- Enough new market-based dispatchable capacity is entering the Victorian market to sufficiently reduce the reliability risk following the next retirement of a brown coal-fired generator in Victoria.
- The ISP Slow Change scenario is unfolding, which includes asset life extensions of existing coal-fired generation.

Under the Application of the RIT-T to Actionable ISP Projects Rules, the VNI West RIT-T Project Assessment Draft Report (PADR) was due to be published in March 2021. AEMO and TransGrid jointly requested an extension to the publication of the PADR to December 2021, which was approved by the AER in accordance with clause 5.16A.4 (c) of the NER. This extension will allow AEMO and TransGrid to:

- Further refine key inputs related to the ISP decision rules for the project, and
- Allow the RIT-T modelling to adopt the latest ISP assumptions from the 2021 IASR, released in July 2021.

The PADR will recommend a proposed preferred option, and provide supporting technical, economic, and modelling information for consultation.

⁷⁴ The decision rules allow for adaptation if future ISPs (2022 or 2024) signal a change in direction away from the transmission cost, market response or ISP scenario assumed.

⁷⁵ Dispatchable resources are those which can firm up the inherently variable nature of renewable generation, including utility-scale pumped hydro, large-scale battery energy storage systems, distributed batteries, virtual power plants (VPP) and other demand side participation (DSP).

⁷⁶ See AEMO, 2020 ISP, Appendix 3, at <https://www.aemo.com.au/-/media/files/major-publications/isp/2020/appendix--3.pdf?la=en>.

3.3.9 Pre-feasibility: Voltage Control in Metropolitan Melbourne and South West Victoria

The Victorian DSN experiences high voltages during minimum demand conditions, particularly in the metropolitan Melbourne area and the south-west transmission corridor. AEMO's Reactive Power Support project (refer Section 3.3.3) will deliver additional reactive support in the area by Q3 2022.

AEMO continue to monitor actual demand trends against demand forecasts. The 2021 ESOO forecasts further declines in minimum demand which signal the potential need for further investment in the next five years to manage the resulting high voltages.

AEMO has identified this as a new priority limitation in the 2021 VAPR. AEMO is undertaking pre-feasibility investigation of the need to deliver the required reactive support, and potential options to meet the need with the intention of commencing a RIT-T in 2022, subject to the outcome of these investigations.

More information is included in Section 4.5.4.

3.3.10 Other priority limitations

In the 2020 VAPR, AEMO identified four priority limitations with potential economic merits for remediation. Section 4.3 provides an update of projects being progressed or investigated to address these limitations.

3.4 Renewable Energy Zone Development Plan (RDP) Stage 1

The Victorian Government's RDP Directions Paper⁷⁷ published in February 2021 identified potential network augmentations that would relieve existing constraints on the Victorian DSN. In August 2021, the Victorian Government requested AEMO to progress six sets of projects identified in the RDP Directions Paper to support the connection of Victoria's renewable energy pipeline.

The proposed minor network augmentations are:

- Implementation of control schemes to alleviate thermal constraints in the Murray River, South West, and Central North REZs.
- Upgrade of various station limiting plant in the Western Victoria, and South West Victoria REZs.
- Implementation of wind monitoring dynamic line ratings in the South West Victoria REZ.

More information on the various minor network augmentations is included in Section 6.4.1.

AEMO has also concluded a call for expressions of interest for services to strengthen the system. Submissions are currently being considered.

Non-contestable proposals for the other minor augmentations will be requested from the relevant asset owners.

3.5 Neighbouring TNSP projects

3.5.1 Project EnergyConnect

PEC is an interconnector between South Australia and New South Wales, with connection to Victoria at Red Cliffs, and indicative capacity of 800 MW. The project is aimed at reducing the cost of providing secure and reliable electricity across the NEM, while facilitating a longer-term transition to low emission energy sources. In February 2019, ElectraNet completed its RIT-T assessment of this project⁷⁸.

Project EnergyConnect broadly consists of:

⁷⁷ See https://www.energy.vic.gov.au/_data/assets/pdf_file/0016/512422/DELWP_REZ-Development-Plan-Directions-Paper_Feb23-updated.pdf.

⁷⁸ See <https://www.electranet.com.au/wp-content/uploads/projects/2016/11/SA-Energy-Transformation-PACR.pdf>.

- A new 330 kV double circuit interconnector from Robertstown in mid-north South Australia to Wagga Wagga in south-west New South Wales, via Buronga and Dinawan.
- A new 220 kV double circuit between Buronga in New South Wales and Red Cliffs in Victoria to replace the existing 220 kV single circuit line.

The AER approved the outcomes of this RIT-T in January 2020, and approved the TransGrid and ElectraNet Contingent Project Applications in May 2021 with a total cost of \$2.27 billion⁷⁹. Project EnergyConnect is expected to be completed by late 2024.

Project EnergyConnect will improve the performance of the Victorian DSN through the provision of stronger interconnection between Victoria, New South Wales, and South Australia. This will provide additional hosting capacity for renewables in the Murray River area, improve system strength in the area, and deliver increased network flexibility in managing network constraints.

3.5.2 Marinus Link

Marinus Link is a proposed 1,500 MW capacity electricity connection to further link Tasmania and Victoria. Marinus Link involves approximately 250 of undersea HVDC cables, approximately 90 km of underground HVDC cables, and converter stations in Tasmania and Victoria. Supporting overhead transmission upgrades are also required in Tasmania.

TasNetworks is proposing to deliver Marinus Link in two stages:

- An initial 750 MW HVDC link between Heybridge (near Burnie) in Tasmania and Hazelwood area in Victoria. Supporting AC transmission network augmentations will be required in Tasmania, but no major augmentations are proposed in Victoria.
- The commissioning of a further 750 MW HVDC link between the same locations, with further AC network augmentations in Tasmania.

In June 2021, TasNetworks published the PACR⁸⁰ which is the final step in the RIT-T process. Based on the modelling for the PACR, the preferred option and optimal configuration for Marinus Link is a 1,500 MW HVDC interconnector, comprising two 750 MW HVDC stages, plus associated AC network upgrades for each stage. Collectively, Marinus Link and supporting AC transmission upgrades are known as Project Marinus.

The PACR notes that the optimal timing of the project is dependent on the future development of the NEM. TasNetworks has considered an optimal timing window for the preferred option based on the scenarios in the 2020 ISP, noting that these are subject to change as AEMO prepares its 2022 ISP. At this stage, the optimal timing for Stage 1 is as early as 2027 and no later than 2031, with Stage 2 required as early as 2029 and no later than 2034. TasNetworks will proceed with the early works required for Project Marinus to be able to achieve a Final Investment Decision (FID) expected in 2023-24, enabling commissioning of Stage 1 and 2 at their earliest in 2027 and 2029 respectively.

AEMO has conducted a high-level assessment of the impact Marinus Link might have on the Victorian DSN if connecting in the Latrobe Valley. Preliminary studies indicate a connection at Hazelwood 500 kV would have a low impact on local constraints, given that the existing local network infrastructure was used to accommodate Hazelwood Power Station with approximately 1,800 MW generation output before its retirement in 2017.

Significant increases in power transfers between Victoria and Tasmania could put increased pressure on Victorian interconnection with other mainland states, potentially strengthening the case for further development of these flow paths.

⁷⁹ TransGrid and ElectraNet – Project EnergyConnect contingent project - AER Final Decision May 2021.

⁸⁰ See <https://www.marinuslink.com.au/wp-content/uploads/2021/06/Project-Marinus-RIT-T-PACR.pdf>.

4. Forecast limitations

This chapter explores potential new limitations that may reduce system performance, impact efficient asset utilisation, or result in additional network constraints.

Key forecast limitation insights

AEMO's *Transmission Development Plan for Victoria* has been designed to meet security and reliability objectives in a cost-effective way over the coming decade. This means it is not necessarily designed to remove all network congestion – particularly where generation investments occur in weaker parts of the grid or outside the least-cost development plan that can be considered through the regulatory framework.

AEMO proactively identifies future limitations through its operational, planning, and connection functions. When identified, a new limitation will trigger further investigation or prefeasibility studies. Projects are added to the plan as they meet regulatory approval hurdles.

The annual VAPR provides an opportunity to build on these investigations, and undertake a full review of the Victorian power system. The VAPR uses detailed analysis to capture the nature, timing, impact, and triggers associated with potential limitations. The focus of this work is on identifying projects that are likely to deliver net positive economic benefits under the current regulatory framework.

This year's VAPR provides a detailed assessment of two key challenges faced by the Victorian DSN over the coming 10 years – rapidly declining minimum demand and the retirement of YPS.

Minimum demand

The increasing uptake of rooftop PV in Victoria has resulted in a reduction in operational demand during daylight periods. Record low demand is being observed in the early afternoon, when the sun is at its strongest. This poses significant challenges in operating the network within voltage limits and meeting minimum system strength requirements. The 2021 ESOO has projected potential negative demand in Victoria as early as 2025, which would present an unprecedented and complex challenge. The retirement of YPS will also compound these issues.

AEMO has identified immediate, short-term, and long term limitations that would need to be addressed to manage voltages during low demand periods. A mix of operational measures and reactive power capability from new generation/battery connections and new grid-connected reactive plant were identified as potential solutions to the limitations.

Further to the limitations related to voltage management, AEMO has also identified a new limitation on export capability to transfer the surplus generation from the minimum synchronous generation unit to neighbouring states during low demand periods.

Retirement of Yallourn Power Station

The retirement of YPS will withdraw almost 1.5 GW of generation capacity, and substantially impact the performance of Victorian DSN in many areas, including:

- Thermal overload of metropolitan Melbourne 500/220 kV transformers and 220 kV transmission lines due to redistribution of generation.

- Voltage instability and over-voltage due to decrease in reactive capability during period of high and low demands, respectively.
- Reduced capability and flexibility in maintaining minimum system strength combinations.

The impact on DSN performance is sensitive to how the Latrobe Valley network would be configured going forward, which in turn will affect asset utilisation and the network need for some assets in the Latrobe Valley.

The 2021 ESOO also forecast that there could be a reliability gap in Victoria after YPS's retirement. AEMO is also investigating further opportunities to mitigate against a potential reliability gap, including options to unlock Victorian generation by investing in solutions that relieve identified limitations.

4.1 Methodology

The VAPR identifies opportunities to address transmission network limitations emerging over the next 10 years, where credible solutions are likely to deliver positive net market benefits. The overall planning approach is described below, and the identified limitations are discussed in the following sections.

4.1.1 DSN augmentation planning approach

To identify network augmentation needs, AEMO first investigates transmission network limitations by:

- Reviewing historical network performance over the previous year (See Chapter 2).
- Reviewing future network performance under a range of demand and generation scenarios considering government policy and economic growth projections through exploratory studies.

For the purposes of the VAPR, a limitation is defined as a network element or location that:

- Is loaded to 90% of its continuous rating, or experiences voltages outside its normal voltage range, during system normal operating conditions.
- Is loaded to 90% of its short-term rating, or experiences voltages outside its contingency voltage range, following a contingency event.
- Does not maintain the minimum three phase fault level for that location for at least 99% of the year.
- Has voltage unbalance levels which do not meet the requirements outlined in S5.1a.7 of the NER.
- Has typical inertia dispatched being less than the secure operating level of inertia, where the typical inertia is the value at one standard deviation below the mean and the secure operating level of inertia is the minimum level of inertia required to operate an islanded inertia sub-network in a secure operating state⁸¹.
- Has not maintained stable voltage control following a credible contingency event as outlined in S5.1.8 of the NER.
- Has a fault level shortfall as outlined in S5.20C.3 of the NER.
- Has a heavily restricted outage window due to other constraints and limitations.

Exploratory studies are carried out to identify DSN thermal and voltage control limitations that may emerge over the next 10 years. Screening studies are used to identify expected limitations, while trigger studies are used to test the system under more extreme scenarios to identify conditions that trigger further limitations.

The VAPR analysis always incorporates a full set of state-wide screening studies, however specific trigger studies are undertaken when expected changes in generation, demand, or other planning inputs are likely to have a significant impact on the flow patterns and behaviour of the system.

⁸¹ For more information see *Inertia Requirements Methodology Inertia Requirements and Shortfalls*, at https://www.aemo.com.au/-/media/Files/Electricity/NEM/Security_and_Reliability/System-Security-Market-Frameworks-Review/2018/Inertia_Requirements_Methodology_PUBLISHED.pdf.

Screening studies identify limitations by assessing network performance in terms of security and performance obligations under a range of different power system configurations. Security and performance obligations define the transmission system’s technical limitations (for example, voltage ranges, stability limits, maximum fault currents, and fault clearance requirements). These obligations ensure that connected assets (and the power system itself) are designed to operate within known technical limits.

For each network element, screening studies are typically undertaken for a base case and a worst-case scenario, in order to capture a wide range of limitations. The worst-case scenario differs, depending on the transmission network element under consideration, and is a variation on the base case scenario designed to test that specific network element. For example, in a particular location the worst-case scenario may be 100% variable renewable energy (VRE) generation output, while in another location the worst case may be 0% VRE.

AEMO identifies possible solution options to address the identified limitations, then estimates the costs of the solution options, and assesses the likelihood of these delivering positive net market benefits. Based on these assessments, the limitations are categorised as shown in Figure 24, and described below.

Figure 24 Identification of network limitations – the planning cycle

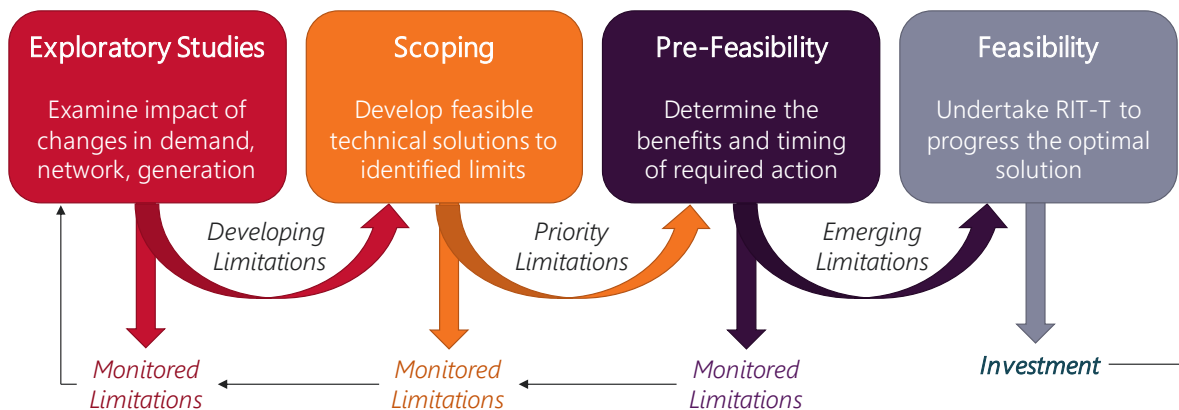

Limitations are categorised as:

- **Emerging limitations** – limitations for which credible solutions are likely to deliver positive net market benefits, and where trigger conditions have been met. AEMO will begin a RIT-T (or other relevant regulatory approval process) within 12 months to identify the optimal solution and investment timing.
- **Priority limitations** – limitations for which credible solutions may deliver positive net market benefits. Following the VAPR publication, AEMO will undertake further pre-feasibility assessment using more detailed market modelling to assess the benefits from credible augmentation options.
- **Monitored limitations** – limitations for which there is currently no credible solution likely to deliver positive net market benefits. AEMO reassesses these limitations annually, when conditions change, or when a new credible solution becomes available.
- **Developing limitations** – a subset of monitored limitations, where triggering conditions may be met before the next VAPR cycle, where triggers may require further study, or where triggering conditions are more likely to change rapidly and therefore require heightened active monitoring. These may include limitations in areas of high investor interest, those related to step changes in supply or demand, or those which have occurred operationally under unusual system conditions.

AEMO performs high-level economic assessments in determining emerging limitations, and may perform these assessments for priority limitations when required. This analysis and categorisation can provide signals for potential non-network development opportunities, such as localised generation or demand response.

AEMO undertakes joint planning with other TNSPs and Victorian DNSPs to address transmission limitations, challenges, and opportunities. Victorian joint planning outcomes have been incorporated into the limitation summaries presented in this chapter.

Appendix A3 has more information on AEMO's approach to transmission network limitation reviews.

4.2 Emerging limitations

AEMO has conducted a combination of power flow modelling and economic assessments to identify new network limitations, following the methodology described in Section 4.1. These studies include all committed developments listed in Section 3.3.

No new emerging (direct to RIT-T) limitations have been identified since the 2019 VAPR

4.3 Priority limitations

AEMO has identified priority limitations for which credible solutions may deliver positive net market benefits in the next 10 years. The new priority limitations in the 2021 VAPR are driven by decreasing demand forecasts and the announced retirement of YPS. Following the VAPR, AEMO will undertake pre-feasibility assessments, including confirmation of the network limitation and assessment of benefits through detailed market modelling.

Five priority limitations are currently under investigation including four priority limitations (#1 to #4 below) identified in past VAPRs and one new priority limitation (#5). All are shown in Figure 25 (in Section 4.4).

Priority limitations identified in past VAPRs

This section presents an update since the 2020 VAPR on the following priority network limitations identified in the past VAPRs.

1. Overloading of the Ballarat – Berrybank – Terang – Moorabool 220 kV line for a credible contingency (trip of the Moorabool – Terang line), due to new connections. A NCIPAP project to alleviate this limitation is now completed, and AEMO is investigating further post-contingent tripping schemes as part of the REZ Development Plan Stage 1 projects. These projects are anticipated to alleviate the limitation. This limitation can be further relieved by implementing possible network solutions highlighted in Section A2.5.
2. Overloading of the Bulgana – Horsham – Murra Warra 220 kV line for a credible contingency (trip of the Bendigo – Kerang line), due to new connections between Horsham and Kerang. AEMO is investigating station upgrades to increase the line rating as part of the RDP Stage 1 projects. The project is anticipated to partially relieve the limitation. This limitation can be further relieved by implementing possible network solutions highlighted in Section A2.7.
3. Overloading of the Red Cliffs – Wemen – Kerang – Bendigo 220 kV line for a credible contingency (trip of the Horsham – Murra Warra – Kiamal 220 kV line), due to new connections between Kiamal and Kerang. A NCIPAP project to alleviate this limitation from August 2021 has been completed, and AEMO is progressing control scheme change to reduce overloading of this line. The NCIPAP and control scheme change projects are anticipated to alleviate the limitation. This limitation can be further relieved by implementing possible network solutions highlighted in Section A2.4.
4. Voltage instability/collapse around Wemen Terminal Station for a credible contingency (trip of the Horsham – Murra Warra – Kiamal 220 kV line), due to new connections between Kiamal and Wemen. AEMO is currently considering projects proposed to strengthen the system, under the RDP Stage 1, which may also be capable of alleviating this limitation.

New priority network limitation

5. High voltages in Metropolitan Melbourne and South West Victoria caused by low and negative demand conditions forecast in the 2021 ESOO over the next decade. AEMO will begin prefeasibility studies with a view to commence a RIT-T if found beneficial.

4.4 Developing limitations

In addition to the five priority limitations, 10 developing limitations are currently under investigation. Six (#6 to #11 below) were identified in past VAPRs and four are new developing limitations (#12 to #15).

Developing limitations identified in past VAPRs

This section presents an update since 2020 VAPR on the following developing network limitations identified in the past VAPRs.

6. Voltage oscillation in western and north-western Victoria during prior outages for a credible contingency. This limitation was identified in the 2019 VAPR as a new monitored limitation. As shown in Section 2.7, this limitation was the top binding limitation over the period. This constraint bound frequently due to a number of network outages required to facilitate generator connection projects, including installation and testing of control schemes. AEMO is continuously reviewing these constraints as revised models are obtained and based on the upcoming outage schedule. The RDP Stage 1 project to strengthen the system at the Western Victoria and Murray River REZs may also assist in reducing the impact of this limitation.
7. Overloading of the Dederang – Glenrowan – Shepparton – Bendigo 220 kV line for a credible contingency (trip of one of the other Dederang – Glenrowan 220 kV lines), due to high New South Wales to Victoria imports, increased maximum demand and generation in regional Victoria. AEMO will continue to consider a post-contingent load shedding control scheme to enable the use of five-minute line ratings. A REZ Development Plan Stage 1 project, that prepares the network for control scheme, is being assessed to address this limitation.
8. Overloading of the Moorabool 500/220 kV transformer for a credible contingency (tripping of the other Moorabool 500/220 kV transformer), due to new connections on the 500 kV lines west of Moorabool, which may require generators on these lines to be constrained. AEMO will continue to consider the potential of implementing a post-contingent generation tripping scheme. A REZ Development Plan Stage 1 project to upgrade limiting plant is being considered to provide relief to this limitation
9. High ROCOF in South West Victoria constraining generators on the 500 kV lines west of Moorabool during prior outage of one of these lines, and for credible trip of another. AEMO will continue to consider the potential benefits of implementing a post-contingent generation tripping scheme.
10. Minimum fault level requirements at Thomastown and Hazelwood fault level nodes caused by lower demand and early retirement of thermal generators. AEMO is undertaking further analysis through the 2021 System Strength and Inertia Review, to be published by the end of the year.
11. Voltage collapse limitation in South West Victoria (tripping of the Moorabool – Mortlake 500 kV line), due to additional generator connections and under high import from South Australia. More information is listed in Section 4.5.5.

New developing network limitations

AEMO has identified the following developing limitations that AEMO is actively monitoring. The numbering used here aligns with the identifiers in Figure 25. The new developing limitations in the 2021 VAPR are driven by increasing generation, increased local demand levels, and the announced retirement of YPS.

12. Overloading of Hazelwood – Yallourn 220 kV lines after YPS retirement. AEMO will continue its investigation into challenges associated with the announced retirement of YPS and will undertake detailed market modelling to assess the benefits from credible augmentation options.

13. Overloading of the Moorabool – Geelong – Keilor 220 kV lines for a credible contingency (trip of the other Moorabool – Geelong – Keilor 220 kV line) due to high generation in South West Victoria and Western Victoria as well as high demand in Greater Melbourne. AEMO will consider the benefits of potential control schemes.
14. Overloading of Cranbourne and Rowville 500/220 kV transformers post YPS retirement. AEMO will continue its investigation into challenges associated with the retirement of YPS.
15. Insufficient outage window on the Hazelwood – Loy Yang 500 kV lines post YPS retirement. The challenges are highlighted in Section 4.5.7 and Section 4.6.4. AEMO will continue its investigation into challenges associated with the retirement of YPS.
16. Figure 25 presents the five priority limitations (See Section 4.3), and the 10 developing limitations.

Figure 25 Priority limitations and developing limitations under investigation

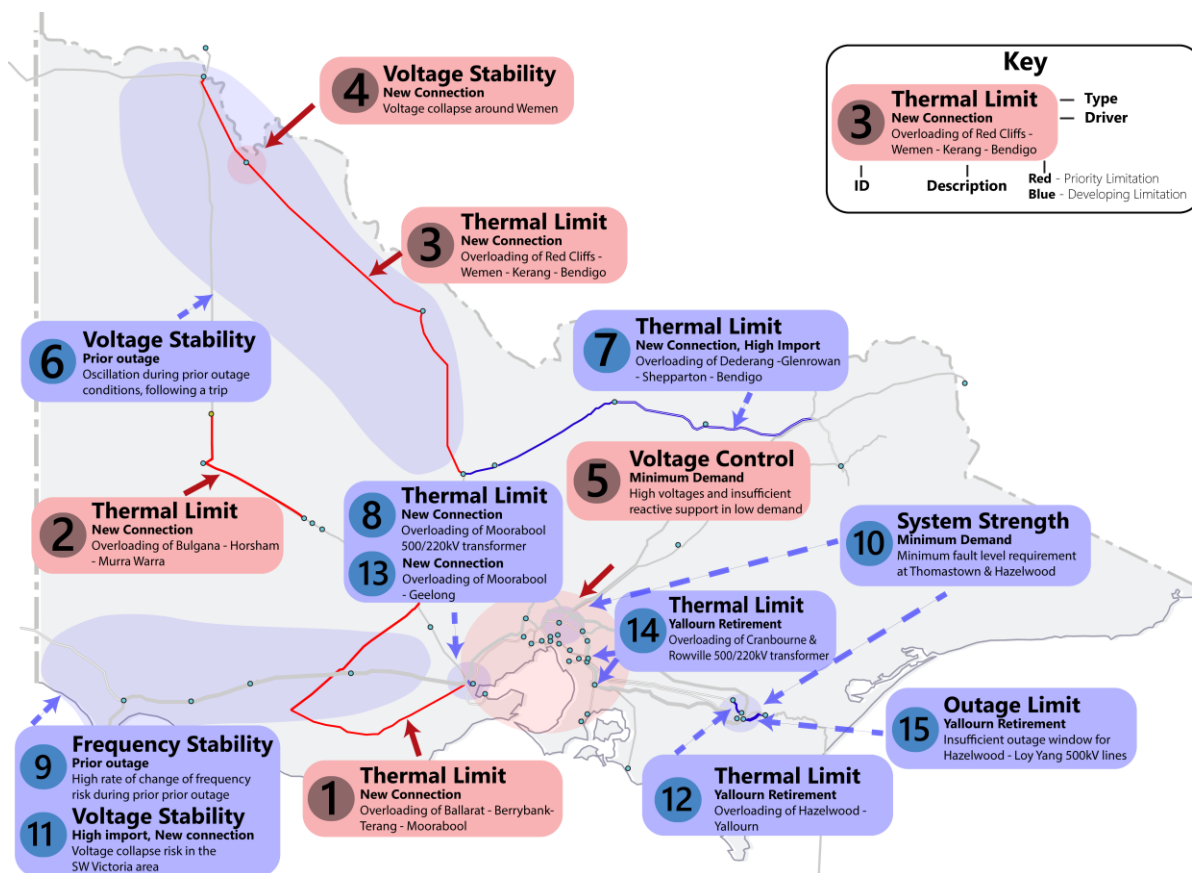

4.5 Other monitored transmission network limitations

AEMO continues to monitor transmission network limitations that may result in supply interruptions or constrain generation, but for which either there are no currently identified needs/triggers, or there are not yet sufficient market benefits to justify the cost of relieving the limitation. A summary of the priority, developing, and monitored transmission network limitations is shown geographically in Figure 26.

Figure 26 Summary of identified limitations by location (including priority, developing, and monitored)

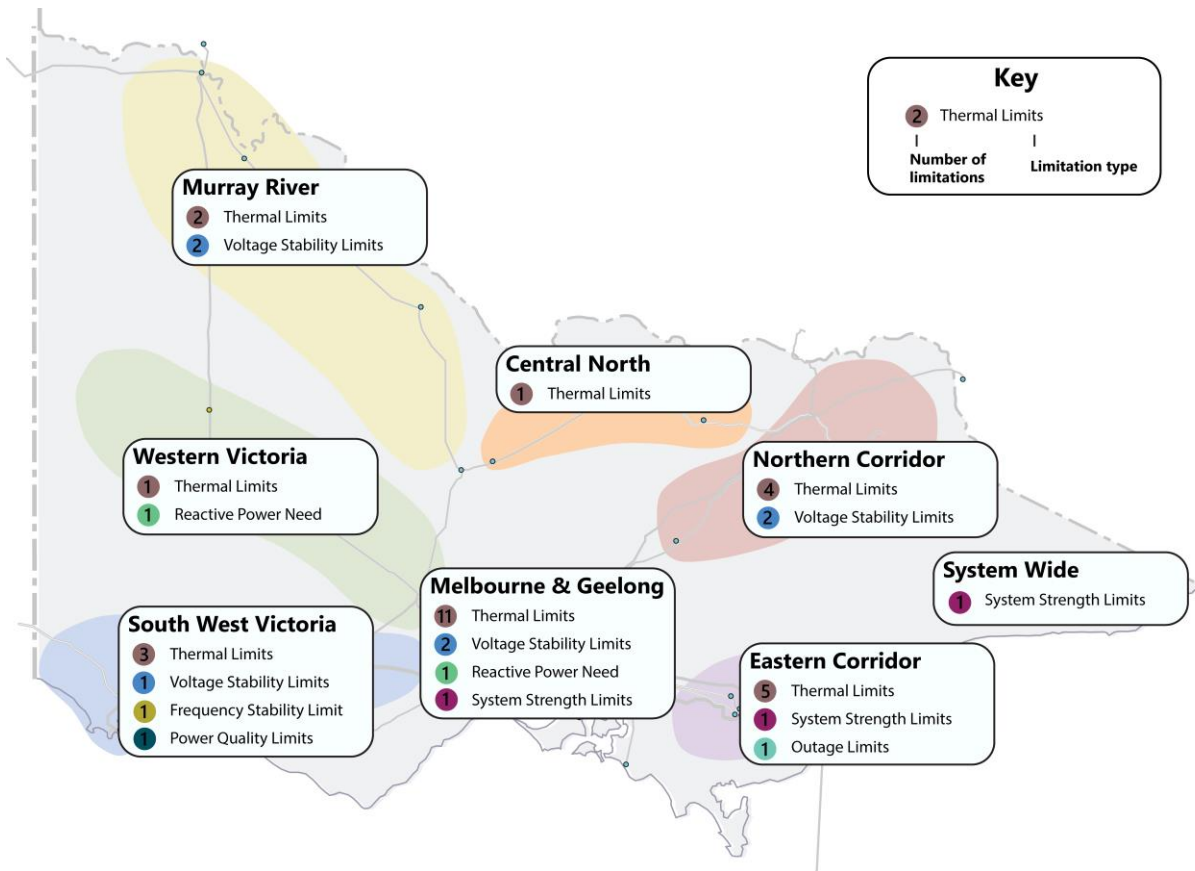

The full list of monitored Victorian transmission limitations can be found in Appendix A2. These limitations are not expected to carry significant impacts within the next five years, and are not currently economic to pursue. However, these may trigger further study if specific system changes or generator investment patterns occur.

For each of these limitations, AEMO will continue to monitor the identified trigger conditions and progress them to prefeasibility and feasibility studies when required. AEMO also welcomes feedback from stakeholders and non-network service providers, where they consider that credible options exist which would deliver positive net market benefits.

The following sections provide more detail on the VAPR's 2021 assessment of monitored limitations.

4.5.1 Thermal limitations

The emergence of new thermal limitations, and the benefits of addressing them, are heavily dependent on the geography and intermittency of both supply and demand. Patterns of network flow and asset utilisation are changing rapidly in Victoria, driven by strong investor interest in renewable generation projects, and strong consumer interest in distributed PV.

Many new generation projects are proposed in western parts of the state, where high-quality solar and wind resources are abundant. However, these parts of the network were not originally designed to support such high connection density, and a number of investors are already facing economic and technical challenges associated with connecting to these weaker parts of the grid.

In the 2021 VAPR, AEMO has identified new monitored thermal limitations associated with the retirement of YPS. The new limitations identified are covered in Section 4.6.

It is worth noting that there might be other unidentified limitations which might constrain renewable generation, particularly where additional renewable connections occur in remote parts of the grid or are outside the optimised investment plans that underpin the ISP and VAPR analysis.

4.5.2 System strength limitations

Under the AEMC's final determination on efficient management of system strength on the power system⁸², AEMO, as the System Strength Service Provider (SSS Provider) in Victoria, is required to provide the right amount of system strength to support the forecast connection of IBR.

Declared and near-term shortfalls

On 13 December 2019, AEMO published a notice of fault level shortfall⁸³ at Red Cliffs Terminal Station and further revised this shortfall on 6 August 2020 due to a change in requirements at the Red Cliffs node⁸⁴. The revised notice specified an immediate fault level shortfall (also referred to as a system strength gap) of at least 66 MVA, and which would continue beyond 2024–25 if not addressed. AEMO is addressing this shortfall through short and long-term activities, as outlined in Section 3.3.5.

Looking forward, the 2020 *System Strength and Inertia Report*⁸⁵ did not forecast any other system strength shortfalls before 2025.

Projected shortfalls beyond 2025

By 2030, the 2020 *System Strength and Inertia Report* identified a risk of shortfalls emerging at Thomastown Moorabool and Hazelwood under high renewable scenarios. The report was completed under previous advice that the retirement of YPS was staggered between 2029 and 2032. AEMO expects the latest announcement⁸⁶ of YPS's retirement by 2028 may bring forward the forecast shortfall. This will be assessed as part of the 2021 *System Strength and Inertia Report* and the 2022 ISP.

Challenges with maintaining system strength above minimum requirement are also compounded by recent reductions in the minimum demand forecast for Victoria. The 2021 ESOO indicates that the state may reach demand levels that would not support a minimum number of synchronous units online when interconnection to neighbouring regions is limited or when neighbouring regions are simultaneously experiencing low demand as covered in the next section.

AEMO has classified this potential inability to keep the required minimum number of synchronous units online for system strength as a developing limitation for heightened monitoring, options analysis, and investigation.

Minimum synchronous unit requirements

Given rapid increases in renewable generation, coupled with falling minimum demands, there are likely to be times over the coming decade where surplus generation is available that cannot be exported across the interconnectors, resulting in units being decommitted (below their minimum stable generation levels), or spilled wind and solar resources.

At these times, the units with the highest bid prices will generally have their output reduced first. However, the Victorian region also has a requirement to maintain a minimum number of synchronous units online for

⁸² See <https://www.aemc.gov.au/rule-changes/efficient-management-system-strength-power-system>.

⁸³ AEMO, *Notice of Victorian Fault Level Shortfall at Red Cliffs*, December 2019, at https://www.aemo.com.au/-/media/Files/Electricity/NEM/Security_and_Reliability/System-Security-Market-Frameworks-Review/2019/Notice_of_Victorian_Fault_Level_Shortfall_at_Red_Cliffs.pdf.

⁸⁴ AEMO, *Notice of Change to System Strength Requirement and Shortfall at Red Cliffs*, August 2020, at https://aemo.com.au/-/media/files/electricity/nem/security_and_reliability/system-security-market-frameworks-review/2020/notice-of-change-to-red-cliffs-220kv-minimum-fault-level-requirement-and-shortfall.pdf?la=en&hash=5C3EDDABDF81891B3989F6FF0466C486.

⁸⁵ AEMO 2020 System Strength and Inertia Report, at https://www.aemo.com.au/-/media/files/electricity/nem/planning_and_forecasting/Operability/2020/2020-System-Strength-and-Inertia-Report.

⁸⁶ See <https://aemo.com.au/en/newsroom/media-release/energy-australia-announces-the-early-retirement-of-yallourn>.

system strength purposes⁸⁷. There are currently 37 combinations of synchronous units that meet this requirement, and at current demand levels it is rare that none of these 37 combinations of synchronous units is available (see Section 2.5.2). If pre-dispatch analysis indicates that these minimums are unlikely to be met (that is, the system strength limitation becomes binding), either pre-contingent or within 30 minutes following a credible contingency, the System Operator may direct an appropriate synchronous generator to come online. This has happened in Victoria previously⁸⁸.

As minimum demands fall in future, it may become increasingly difficult to maintain this minimum requirement – particularly at times of high renewable generation availability where synchronous units will begin to be displaced from the dispatch stack. At these times, renewable generation output may need to be reduced to ensure system strength requirements are met. South Australia has encountered similar issues over the last three years, with synchronous generating units being directed online, and ElectraNet is completing a remediation project to install additional synchronous condensers to address this issue⁸⁹.

Minimum operational demand assessment to maintain System Strength

The synchronous machine combinations required to maintain sufficient system strength in Victoria have an aggregate minimum generation requirement of 800 MW to 1,600 MW. During times when operational demand falls below this threshold, Victoria must export surplus generation to neighbouring regions.

The 2021 ESOO forecasts that Victorian demand will fall within the aggregate minimum generation range for synchronous machine combinations from 2023-25. This VAPR further forecasts that the Victorian minimum demand levels will fall below a threshold value under which export capabilities to New South Wales and Tasmania could be exhausted between 2027 and 2029, as shown in Figure 27. The minimum operational demand thresholds levels in Victoria are assessed to be between -600 MW and 200 MW, depending on the synchronous machine combinations for maintain sufficient system strength, assuming a 1,400 MW notional Victorian export capability through Victorian interconnectors. Potential mitigation options include the installation of additional synchronous condensers and battery energy storage systems (BESS).

Figure 28 highlights where there would be increasing periods of the year where projected operational demand is below the minimum generation requirements, and increased binding of network security limits is expected. AEMO is assessing a range of minimum demand thresholds under which the Victorian network can operate securely under various conditions.

AEMO is investigating various mitigation measures and solutions in Victoria that can improve system security at times of very low or negative demand conditions, including:

- Maintaining system strength through sources other than synchronous generators such as synchronous condensers. This will reduce the surplus energy in the network at times of low demand conditions.
- Leveraging future energy storage installations.

As reported in the 2021 ESOO⁹⁰, AEMO is also investigating additional options that do not relate to the Victorian DSN:

- Management of DER in the distribution network through systems like Project EDGE⁹¹ and DER management platforms.
- Emergency backstop PV curtailment capability as a last resort.

⁸⁷ AEMO, *Transfer Limit Advice – System Strength*, July 2021, at https://aemo.com.au/-/media/files/electricity/nem/security_and_reliability/congestion-information/transfer-limit-advice-system-strength.pdf?la=en.

⁸⁸ See Market Notice 70102, 70103, 70119 and 70143 at <https://aemo.com.au/en/market-notice>.

⁸⁹ See <https://www.electranet.com.au/what-we-do/projects/power-system-strength/>.

⁹⁰ See Section 6.1.4, at https://aemo.com.au/-/media/files/electricity/nem/planning_and_forecasting/nem_esoo/2021/2021-nem-esoo.pdf.

⁹¹ See <https://aemo.com.au/en/initiatives/major-programs/nem-distributed-energy-resources-der-program/der-demonstrations/project-edge>.

Figure 27 Minimum operational demand thresholds in Victoria

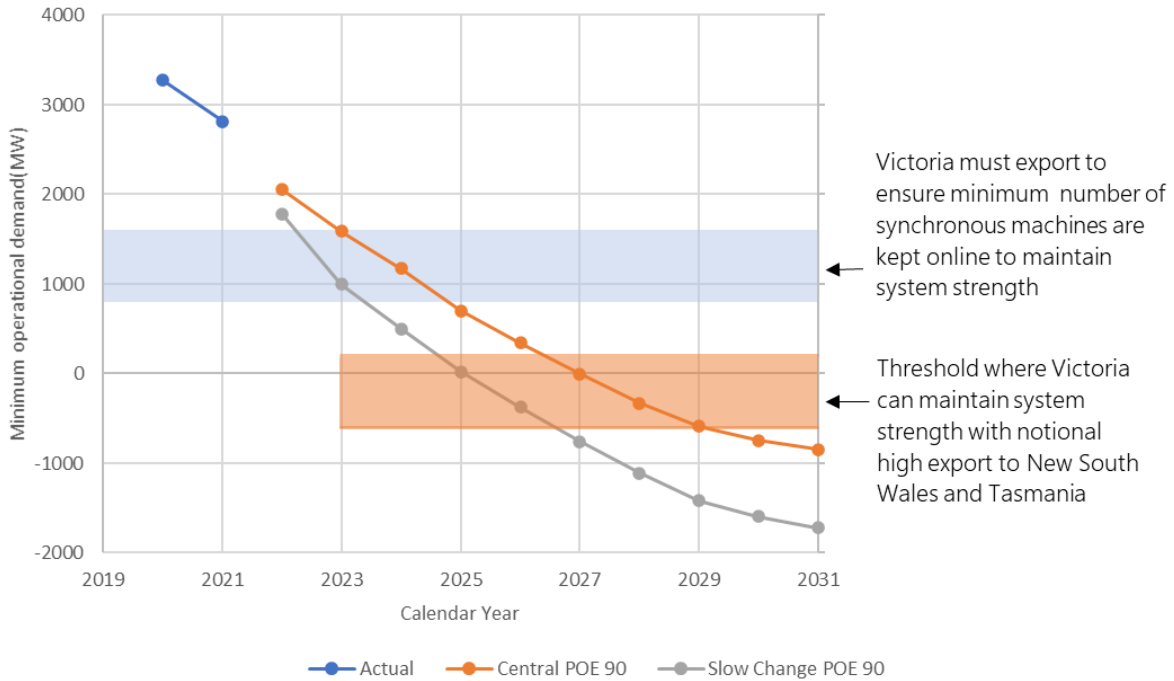

The assumed export capability is 478MW to Tasmania and 900MW to New South Wales based on the published interconnector capabilities.⁹²

Figure 28 Operational demand projection duration curves by financial year

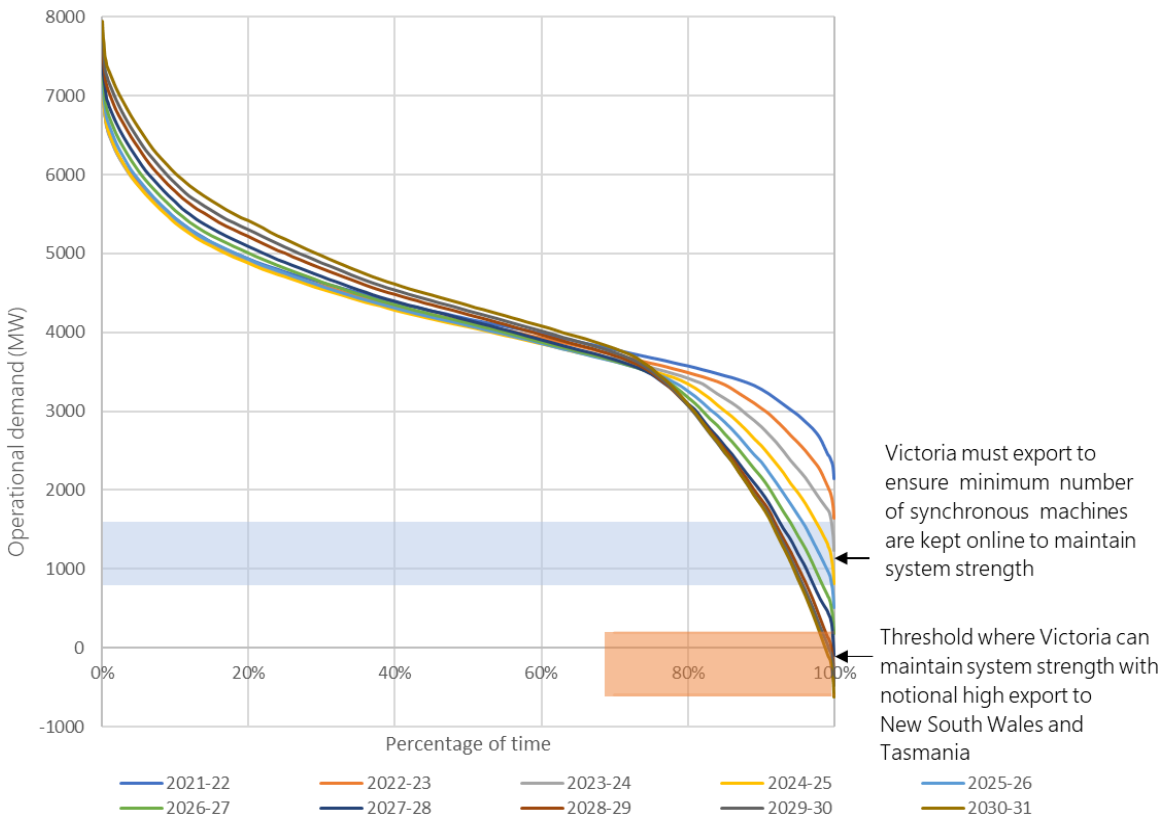

From 2021 ESOO, 90% POE minimum demand forecasts, shoulder season.

⁹² See https://aemo.com.au/-/media/files/electricity/nem/security_and_reliability/congestion-information/2017/interconnector-capabilities.pdf

Future REZ system strength requirements

Each new connecting generator is required to implement or fund system strength remediation, such that its own connection does not have an adverse impact on the overall system strength requirements of the network. This means that in some locations, the connection proponent will be required to demonstrate system strength remediation is in place before connection approvals can be granted.

The Victorian Government has requested AEMO, as part of its RDP, to progress with procurement activities for services to strengthen the system to facilitate new generation connections at Murray River, Western Victoria and South West Victoria REZs.

As reported in the 2020 VAPR, the 2020 ISP forecasts the available fault level in each Victorian REZ, and the approximate system strength remediation that may be required by proponents under optimal generator build patterns. Refer to Section 4.5.2 of the 2020 VAPR for more information on this analysis.

Future Rule requirements

On 21 October 2021, the AEMC made a final determination on the efficient management of system strength on the power system⁹³. Tackling system strength from the supply side, demand side, and a coordination perspective, the new framework aims to provide a more forward-looking, coordinated solution to the supply and demand of system strength in the NEM.

The Rule introduces a new obligation on transmission networks to provide the right amount of system strength to support the connection of IBR as forecast by AEMO. The new system strength standard must be met by a subset of TNSPs, known as SSS Providers. It requires SSS Providers to use reasonable endeavours to plan system strength services to meet AEMO's (system planning):

- Forecast of future IBR connections for each system strength node.
- Three-phase fault level required for a secure system at each node.

As SSS Provider for Victoria, AEMO will be responsible for meeting the above new obligations, commencing on 1 December 2022, with system strength services required no later than 2 December 2025.

Commencing on 15 March 2023, the demand side and coordination arrangements of the new framework will allow new connecting parties demanding system strength to either self-remediate their system strength impact or pay a system strength charge to access the system strength services provided by AEMO as Victoria's SSS Provider. As Victoria's SSS Provider, AEMO will also be responsible for setting Victoria's system strength charge in line with the NER, the AER's Transmission Pricing Methodology Guideline, and AEMO (System Planning) guidance.

4.5.3 Inertia limitations

Power systems with high inertia can resist large changes in system frequency arising from contingency events that create an imbalance between supply and demand.

With the increase in DER and non-synchronous renewable generation, system inertia is likely to decrease, making it more difficult to manage power system frequency events. Under the NER (and in accordance with the published Inertia Requirements Methodology⁹⁴) the satisfactory and secure requirements for synchronous inertia are identified for each NEM region under islanded operating conditions. As the Inertia Service Provider for Victoria, AEMO is required to remediate any inertia shortfall identified.

The *2020 System Strength and Inertia Report* has not declared a shortfall for Victoria⁹⁵. The report assessed the available inertia in Victoria and found that a completely islanded Victorian region could fall below both

⁹³ See <https://www.aemc.gov.au/rule-changes/efficient-management-system-strength-power-system>.

⁹⁴ AEMO, *Inertia Requirements Methodology Inertia Requirements and Shortfalls*, June 2018, at https://www.aemo.com.au/-/media/Files/Electricity/NEM/Security_and_Reliability/System-Security-Market-Frameworks-Review/2018/Inertia_Requirements_Methodology_PUBLISHED.pdf.

⁹⁵ AEMO, *2020 System Strength and Inertia Report*, December 2020, at https://www.aemo.com.au/-/media/files/electricity/nem/planning_and_forecasting/Operability/2020/2020-System-Strength-and-Inertia-Report.

the minimum threshold level of inertia and secure operating level of inertia for periods across the five-year outlook.

Beyond the five-year outlook, the shortfall is expected to grow, especially with the retirement of YPS by 2028.

Figure 29 Projected inertia in Victoria

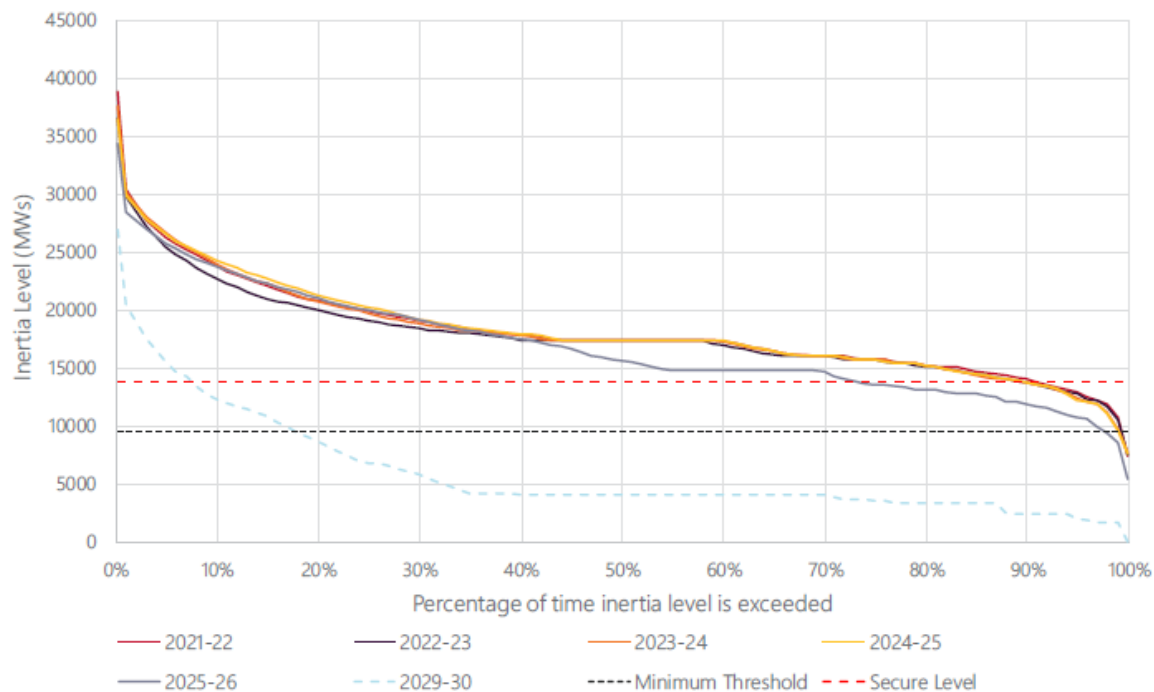

It should be noted that the inertia level forecast shown in Figure 29, which was extracted from the 2020 *System Strength and Inertia Report*, is based on the previously available retirement dates for YPS between 2029 and 2032. Therefore, the level of inertia available is expected to decrease; this will be covered in the 2021 *System Strength and Inertia Report*.

However, Victoria’s strong interconnection with neighbouring regions makes islanded operation less likely than for other regions, and no inertia shortfalls are currently projected ahead of generator closures in the Latrobe Valley. The VNI West project is likely to further strengthen interconnection and reduce Victorian inertia risks late in the decade.

4.5.4 Voltage limitations

The 2020 NSCAS report⁹⁶ did not identify any NSCAS gaps related to voltage limitations in the Victorian region. However, it did identify a range of potential issues for closer monitoring. The VAPR has undertaken further review, with the results presented below.

High voltages in Metropolitan Melbourne and South West Victoria

The Victorian DSN experiences high voltages during minimum demand conditions, particularly in the Metropolitan Melbourne area and the south-west transmission corridor. AEMO currently manages this by operational intervention, including 500 kV transmission line switching and utilising an NMAS contract for reactive services. The historical use of these measures is described in Section 2.5.2. AEMO’s Victorian Reactive Power Support project (refer Section 3.3.3) will deliver additional reactive support in the area by Q3 2022.

AEMO continue to monitor actual demand trends against demand forecasts. The 2021 ESOO forecasts further declines in minimum demand, as shown in Figure 30.

⁹⁶ AEMO, December 2020, at https://www.aemo.com.au/-/media/files/electricity/nem/planning_and_forecasting/Operability/2020/2020-NSCAS-Report.

Figure 30 2021 ESOO forecast 90% POE shoulder minimum operational demand (sent-out) for Victoria (Central scenario)

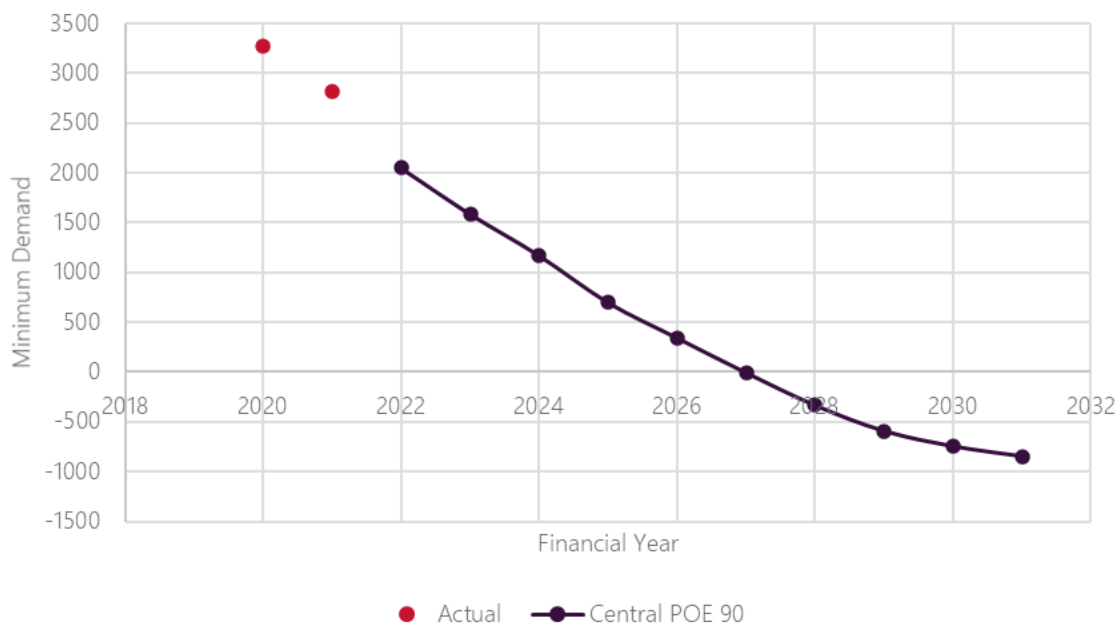

In the next five years, minimum demand is expected to decrease rapidly due to increased distributed PV uptake. This decline is expected to continue, including potential negative demand from 2027 in the Central scenario. However, the rate at which minimum demand decreases in the medium term is expected to slow in the early 2030s, due to electric vehicle (EV) growth, increased battery capacity, and electrification (switching to electricity from other fuels).

AEMO has performed an assessment of reactive power needs in Victoria over the next 10 years, using the 2021 ESOO forecasts. This assessment signals the potential need for further investment in the next five years, as summarised in Table 16. Further decline of demand and the retirement of YPS are the main drivers for the additional reactive power capability requirement, up to 600 MVar, to manage voltages post contingency. The most onerous contingency was identified to be the loss of a synchronous machine and its associated auxiliary load which provided the largest absorption reactive power.

Table 16 Additional reactive power need in Victoria for the next 10 years

Outlook	Identified additional reactive power need	Drivers for the additional need	Mitigation measures/actions
Immediate-term (present to 2024)	Up to an additional 200 MVar absorption reactive power.	Further decline of operational demand in 2021 ESOO.	<ul style="list-style-type: none"> Utilisation of existing operational measures, including the dispatch of reactive capability from generation plant via AEMO’s VAR Dispatch System (VDS).
Short-term (2024-26)	Up to an additional 400 MVar absorption reactive power from status quo.	Further decline of operational demand in ESOO 2021 to as low as 344 MW.	The above measures, plus: <ul style="list-style-type: none"> AEMO has classified this need as a priority limitation for further pre-feasibility assessment with the intention of commencing a RIT-T.
Long-term (2026-31)	Up to an additional 600 MVar absorption reactive power from status quo.	Further decline of operational demand in 2021 ESOO. Retirement of YPS from 2028.	The above measures, plus:

Outlook	Identified additional reactive power need	Drivers for the additional need	Mitigation measures/actions
			<ul style="list-style-type: none"> AEMO has classified this as a monitored limitation and will continue to monitor changes on the network. Utilisation of reactive capability of new generation and energy storage in Latrobe Valley and South West Victoria.

High voltage at Eildon power station

There has been no change to this issue since the last VAPR. During periods of low demand and low power transfer between Victoria and New South Wales, high voltages may be experienced in the DSN at Eildon Power Station (EPS) and nearby stations.

This high voltage issue has been successfully managed by operational measures and AEMO has not identified a need for any further network or non-network investment to address these issues in the near-term future.

4.5.5 Stability limitations

South West Victoria stability limitation

VAPR 2020 reported a developing limitation of voltage collapse in South West Victoria (for a contingency of Moorabool – Haunted Gully line) due to additional generator connections and under high import from South Australia.

AEMO investigated this limitation further and identified that a voltage instability issue exists for a single credible contingency of the Moorabool – Mortlake or Moorabool – Haunted Gully 500 kV line under certain operating conditions. Investigations also confirmed that the voltage collapse is expected to eventuate during periods of high import from South Australia across the Heywood interconnector coinciding with high generation in South West Victoria. A reduction or loss of Alcoa Portland (APD) load would have a similar impact as additional generation in the area on this limitation.

With existing and committed generation, this limitation can be managed by operational measures such as constraints on local generation and/or South Australia import via Heywood. However, as additional generation (not currently committed) connects to the South West Victoria 500 kV network, AEMO may trigger an investment to address this limitation. AEMO is currently developing a set of new constraint equations to manage this limitation. The severity of this limitation will be better understood based on the binding information of this constraint equation.

AEMO has recently reclassified the loss of the APD load with a single contingency of the Moorabool – Mortlake or Moorabool – Haunted Gully 500 kV line to be credible which is expected to negatively impact the voltage instability in the area. Further studies will be undertaken to understand the impact.

4.5.6 Large industrial load

AEMO continues to assess the impact of the closure of a large industrial load in Victoria, such as the APD smelter, to understand the impact of any large load change on the network. Note that AEMO has also assessed the impact of a large generation plant closure, YPS, on network asset utilisation (see Section 4.6).

AEMO has found that the impact of the retirement of a large industrial load, such as the 500 MW smelter, is similar to that identified in 2020 VAPR – the Victorian daily demand profile would be offset downwards by the size of the plant, resulting in a reduction in both maximum and minimum regional demand by the same amount. The effects of this on the DSN could be both positive and negative.

Maximum demand implications are that the closure of a large industrial load is projected to:

- Improve the system’s ability to maintain reliability during summer, and therefore reduce the likelihood of activating emergency reserves or shedding load.
- Reduce the state’s reliance on imports from other regions, and particularly across the VNI, which is often constrained at high temperatures due to both thermal and voltage stability limitations.

Minimum demand implications are that such a closure would be projected to:

- Further exacerbate the high voltage issues seen in Victoria during low demand periods. AEMO has considered the possibility of such large industrial load retirement when sizing the Victorian Reactive Power Support project, however such a retirement may accelerate the need for further reactive plant. Initial sensitivity studies suggest a need of additional 200 MVar absorption reactive power to safely manage voltage following a 500 MW reduction in industrial load⁹⁷.
- Accelerate the need for operator intervention or network investment to meet state-wide system strength requirements, by putting downward pressure on the number of synchronous units online at any one time.
- Increase Victorian exports, and potentially allow other states to access additional low-cost renewables from the southern states (this likely applies at all times, not just minimum demand).

Security implications are that it would be projected to:

- Introduce new thermal and stability constraints on existing and future generation connected to the 500 kV network in the south-western corridor. In particular, this generation would need to be transferred further to meet load, and may face greater thermal competition with imports from South Australia.
- Reduce the size of several credible contingency events (and the associated constraints this introduces). For example, currently a trip of the APD smelter in response to a 500 kV line contingency is one of the most significant credible contingency events in the state, and is the primary factor in a number of Victorian constraint equations – particularly the voltage stability export limit, for example the $V^{N_NIL_1}$ and $V^{N_HWSM_xxx}$ constraint equations.
- Improve the reliability and security of the Heywood interconnector, where a control scheme is currently used to manage voltage stability and frequency for loss of both 500 kV lines west of Moorabool. This control scheme isolates South Australia from Victoria rather than needing to supply the smelter load from across the border. Without this scheme, parts of South Australia would be more prone to voltage instability, possibly leading to load shedding. Without this load, the control scheme would no longer be required, and the probability of a Victoria – South Australia separation event would be reduced.

4.5.7 Outage window limitation

At times of low demand conditions in the network, outage planning of 500 kV lines between Hazelwood terminal station (HWTS) and Loy Yang power station (LYPS) becomes more challenging, due to reduction in the outage window for certain outages.

Transmission network outages are necessary for maintenance work, repair and augmentations to maintain system reliability. When the operational demand in Victoria region falls below a threshold which depends on non-Loy Yang generators’ availability and network conditions, AEMO has indicated difficulty in scheduling HWTS-LYPS line outages due to challenges in post-contingent voltage management and system strength concerns.

In addition to the HWTS-LYPS line outages, AEMO also has experienced difficulties in scheduling other planned outages due to various operational challenges. An example was the planned outage for the necessary work to reconnect the 500 kV lines between Heywood and Moorabool after the lines were damaged by severe weather conditions. This outage required a long continuous duration without a pre-agreed recall time, resulting in challenges associated with South Australian system security and maintaining the reliability of supplying APD load following a credible contingency during the outage period. Another example is 220 kV line outages in north-west Victorian network requiring renewable generators in

⁹⁷ The conducted studies assume the 500 kV connected line reactors at APD will remain operational following the retirement.

north-west Victoria and south-west New South Wales to be constrained and/or regional SVCs to be operated in manual mode or switched off to maintain system security during the outage period.

AEMO continues to monitor changes in operating conditions and their impact on necessary network outage planning.

4.6 Retirement of Yallourn Power Station

Energy Australia has announced that all four units (1,450 MW) at YPS will be retired in mid-2028⁹⁸. This represents a bring forward of the initial plan to progressively retire each unit commencing in 2029. The 2021 ES00⁹⁹ published in August 2021 forecasts expected unserved energy (USE) increasing above the reliability standard in Victoria from 2028-29 unless there is further commitment of dispatchable capacity. As part of this VAPR, AEMO assessed the impact of the retirement on Victorian DSN performance in the following area:

- Latrobe Valley DSN configuration.
- Network limitations.
- Utilisation of DSN assets.
- Supply reliability.

The assessment of the impact of YPS retiring is based on three Hazelwood terminal station (HWTS) 500/220 kV transformers in service, which is consistent with the current configuration.

4.6.1 Latrobe Valley DSN configuration

Currently, the Latrobe Valley DSN is usually operated with HWTS buses 1-4 tied together and buses 5-6 tied together separately where a single Yallourn generating unit (YPSW1) is connected to bus group 1-4 with the other units connected to bus group 5-6. This configuration is called radial mode, because generation from YPSW1, together with other generation connected to the 500 kV, will be sent out of the Latrobe Valley only through the 500 kV network, while the generation from the remaining three Yallourn units would be delivered to Melbourne through the 220 kV lines between YPS – HWPS – Rowville Terminal Station (ROTS).

Alternative to the radial mode, there are a number of other possible Latrobe Valley DSN configurations, with the most common alternative mode called parallel mode, where generation from power stations within the Latrobe Valley is sent out of the Latrobe Valley using both the 500 kV network and 220 kV network. Figure 31 and Figure 32 demonstrate the DSN in the radial mode and the parallel mode.

The Latrobe Valley DSN configuration might need to be changed following the retirement of YPS, as the currently system normal mode (radial mode) may no longer be effective. Without generation from Yallourn and any new generation connected to the 220 kV network between HWTS and ROTs (via Yallourn), the existing HWTS-YPS, HWTS- ROTs and YPS-ROTS 220 kV lines will no longer transfer Latrobe Valley generation to Melbourne.

The optimal operating configuration for the DSN post Yallourn retirement has not been identified. AEMO will continue to explore effective configuration options to identify the optimal configuration post Yallourn retirement for system normal and outage condition.

⁹⁸ See <https://www.energyaustralia.com.au/about-us/media/news/energyaustralia-powers-ahead-energy-transition>.

⁹⁹ See https://aemo.com.au/-/media/files/electricity/nem/planning_and_forecasting/nem_esoo/2021/2021-nem-esoo.pdf?la=en&hash=D53ED10E2E0D452C79F97812BDD926ED.

Figure 31 Latrobe Valley in radial mode

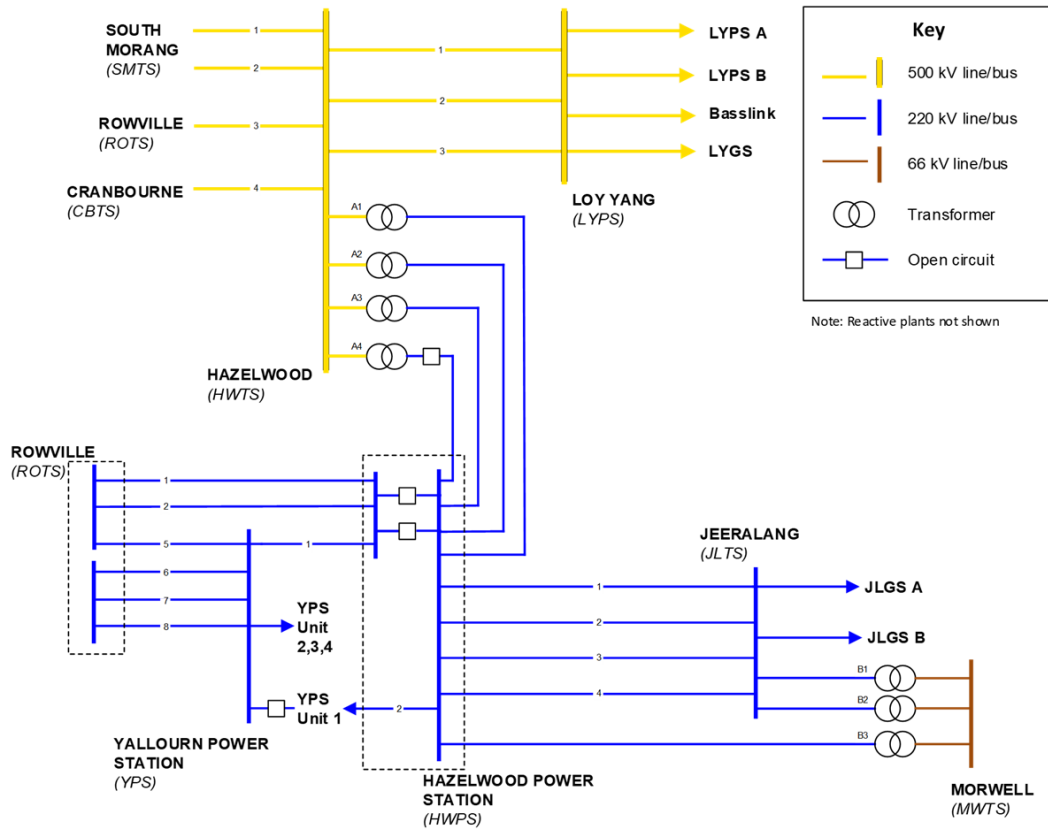
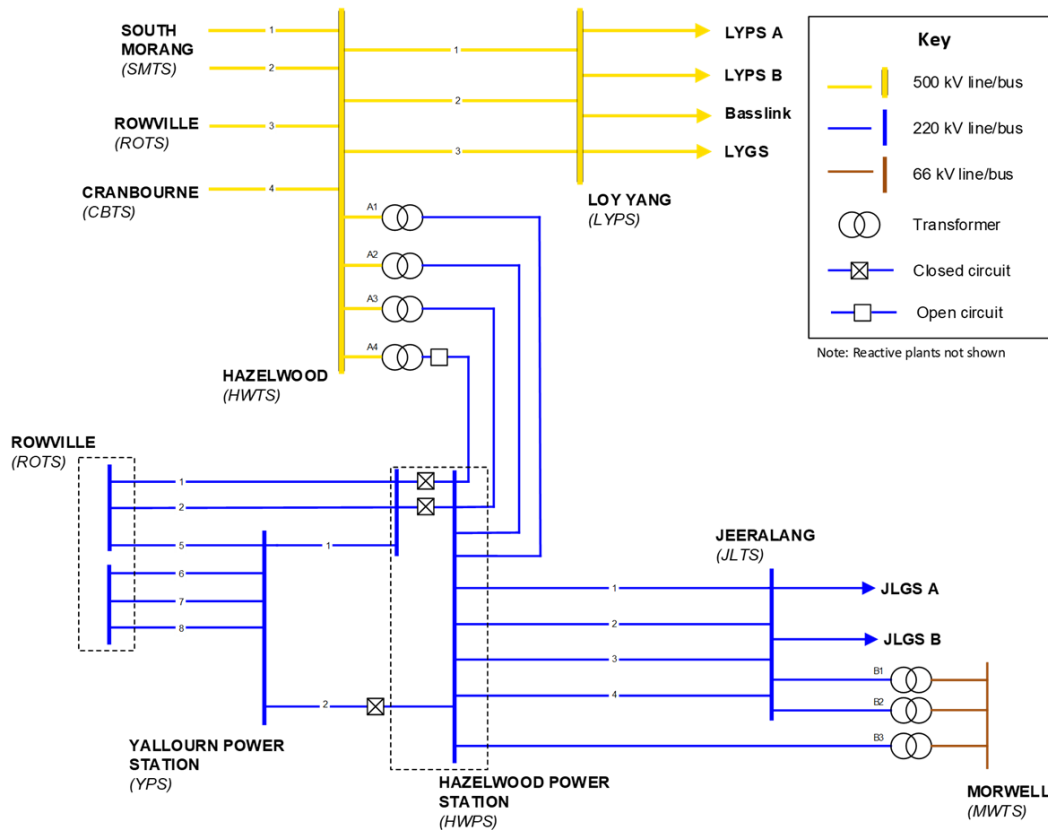

Figure 32 Latrobe Valley in parallel mode



4.6.2 Impact on network limitations

The assessment was conducted based on a Latrobe Valley DSN configuration of either radial mode or parallel mode, three Hazelwood 500/220 kV transformers, and committed projects. Additional large-scale batteries (up to 650 MW), renewable generation (up to 2,200 MW) at the Latrobe Valley, and Marinus Link (1,500 MW) were also considered as part of the sensitivities.

Radial mode

When the Latrobe Valley DSN is in radial mode, the retirement of YPS with up to 1,450 MW reduction of generation capacity in time of high and maximum demand would:

- Increase existing thermal capacity limitations associated with the transformers in the Melbourne metropolitan area as the loading on the transformers could be increased above their capacity more often, especially ROTS A1 500/220 kV transformer under system normal conditions, and further overloading of the Cranbourne Terminal Station (CBTS) A1 500/220 kV.
- Increase existing thermal capacity limitations on the Ringwood Terminal Station (RWTS) to Thomastown Terminal Station (TTS) 220 kV line and the Templestowe to TTS 220 kV line, as the loading on these lines could be increased above the line ratings more often under contingency conditions.
- Increase existing thermal capacity limitations on the South Morang Terminal Station (SMTS) to TTS No. 1 and No. 2 220 kV lines and the KTS to TTS No. 1 220 kV line, as the loading on these lines could be increased above the line ratings more often under contingency conditions.
- Increase existing thermal and voltage stability limitations associated with VNI, due to increases in the state's reliance on imports from other regions, and particularly across the VNI.
- Reduce the reactive power margin within Victorian major load centres, due to a decrease in voltage support capability.
- See low voltage conditions post contingency at Tyabb Terminal Station (TBTS), due to a bigger voltage drop resulting from higher impedance between generation and demand.

In radial mode, additional Latrobe Valley battery or generation, or Marinus Link, will offset the impact of YPS retirement on VNI limitations and improve voltage control and stability due to additional active and reactive power capacity brought in by these projects. Additional Latrobe Valley batteries could relieve the thermal capacity limitations associated with 500/220 kV transformers and 220 kV lines in the Melbourne metropolitan area mentioned above, if they are connected to locations where their output can be transferred to the Melbourne load centres via the 220 kV network between HWTS-YPS-ROTS.

Parallel mode

When the Latrobe Valley DSN is in parallel mode, the impact of the retirement on DSN limitations in time of high and maximum demand is the same as radial mode, except:

- Additional thermal capacity limitations associated with the HWPS-YPS No. 1 and 2 220 kV lines are created, as the loading on these lines could be increased above their rating post contingency only under the parallel mode. De-energisation of one or multiple YPS-ROTS lines could be used as an operational measure to reduce loading on these lines.
- The thermal capacity limitations associated with the 500/220 kV transformers and 220 kV lines in the Melbourne metropolitan area under the radial mode are relieved, as the loading on the transformers and lines could be reduced when more generation is pushed through the 220 kV HWPS-YPS-ROTS lines under the parallel mode.
- The low voltage condition post contingency at TBTS is removed due to shorter electrical distance when Latrobe Valley generation is delivered to ROTS via the 220 kV network in parallel mode,
- In parallel mode, additional Latrobe Valley battery or generation, or Marinus Link, will increase transfer on the 220 kV network between HWTS-YPS, HWTS-ROTS, and YPS-ROTS, and therefore increase thermal

limitation associated with these lines. In extreme cases, thermal capacity limitations were observed on the CBTS and ROTS 500/220 kV transformers. AEMO will monitor new connection projects in this area and may need to conduct feasibility studies to justify investment into potential solutions, including upgrading of the existing 220 kV lines or installation of new lines.

Minimum demand with Latrobe DSN in either mode

The YPS retirement, which results in a substantial reduction of the reactive capability it provides in time of low and minimum demand, would:

- Further exacerbate high voltage issues, mainly seen in South West Victoria. See Section 4.5.4 for more information.
- Deteriorate system strength due to a reduction in available generation unit combinations to meet the minimum generation unit requirements for providing minimum system strength requirements. As a result, the need for operator intervention or network investment to meet state-wide system strength requirements may accelerate.
- Additional Latrobe Valley battery or generation, or Marinus Link, will offset the impact of YPS retirement on voltage control, due to additional active and reactive power capacity brought in by these projects.

4.6.3 Asset utilisation

Asset utilisation is subject to a number of factors such as mode of operation, generation connection, and change in network configurations, as discussed in the previous section. This assessment of the impact of YPS on utilisation of relevant assets is based on three HWTS 500/220 kV transformers in service, consistent with the existing conditions and AusNet Services' asset renewal plan (see Chapter 5 for more details). At least three HWTS 500/220 kV transformers are required for providing sufficient transformer firm capacity to allow for utilising the full capacity of the 220 kV network between HWTS and ROTS to deliver Latrobe Valley generation to load centres. Nevertheless, the optimal number of transformers will be determined in a cost benefit assessment.

The utilisation duration curves presented in this section were obtained by using hourly supply demand balance, with standard profiles for wind and solar generation, historical profiles for hydro generators and interconnectors, and with the remaining load supplied by coal and gas generators. Network loadings were apportioned based on the impedance of the elements in deriving indicative asset utilisation. It should be noted that utilisation is calculated based on the rating of the various assets which are temperature sensitive. Continuous ratings are used for system normal, while short term ratings are used for post-contingency scenarios.

AEMO has considered the following cases in assessing the impact of YPS retirement on utilisation of the assets:

- Case 1 – Radial mode of operation with YPS fully generating.
- Case 2 – Radial mode of operation with YPS retirement.
- Case 3 – Parallel mode of operation with YPS retirement

Figure 33 shows the utilisation of the CBTS A1 500/220 kV transformer. The transformer is projected to be overloaded if operated in a radial configuration (Case 2) for approximately 10% of the time. In parallel configuration, the loading on the CBTS A1 transformer is projected to remain below 100% (Case 3).

Figure 33 CBTS A1 500/220 kV transformer load duration curve

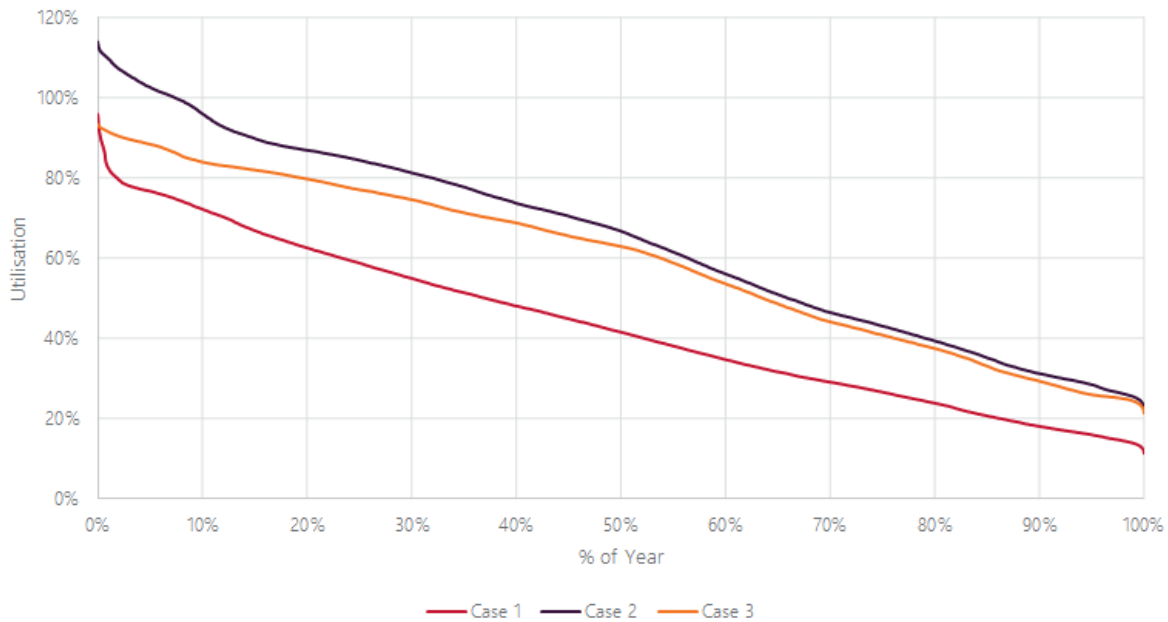

Figure 34 shows that under Case 2, the ROTS A1 transformer is projected to overload approximately 7% of the year. In parallel configuration, the ROTS A1 transformer loading remains below 100% (Case 3).

Figure 34 Rowville A1 500/220 kV transformer load duration curve

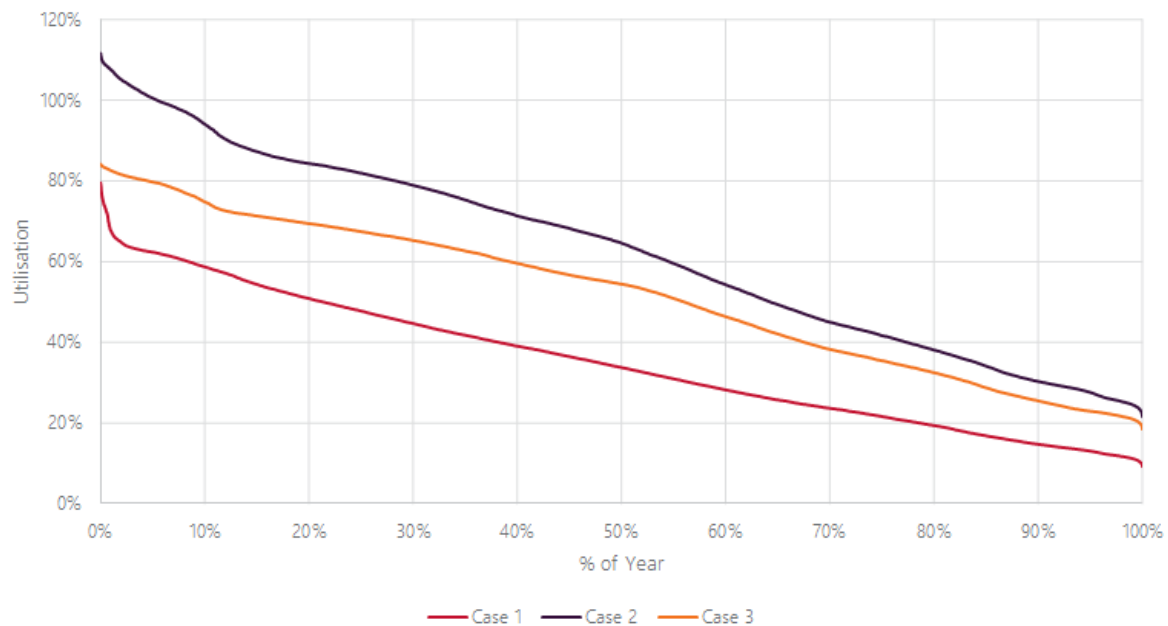

Figure 35 shows that for the cases considered, the loading on the HWTS transformers, under system normal conditions, is below 100% irrespective of the mode of operation. It also shows that utilisation of the transformers is much higher in the cases where the 500 kV and 220 kV networks are operated in parallel (Case 3) than the cases where they are operated radially (Case 1 and Case 2).

Figure 35 HWTS transformer load (under system normal) duration curve

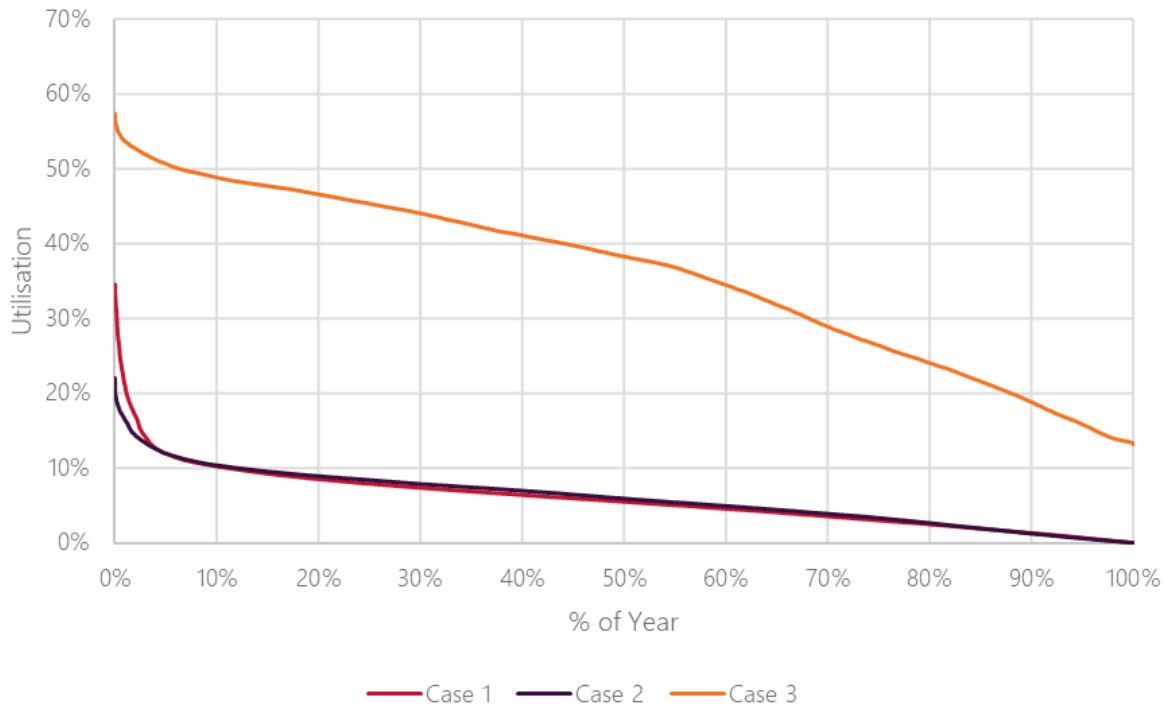

Figure 36 shows that the loading under a contingency, of the HWTS transformers is significantly higher when the network is operated in parallel.

Figure 36 HWTS transformer load (under contingency) duration curve

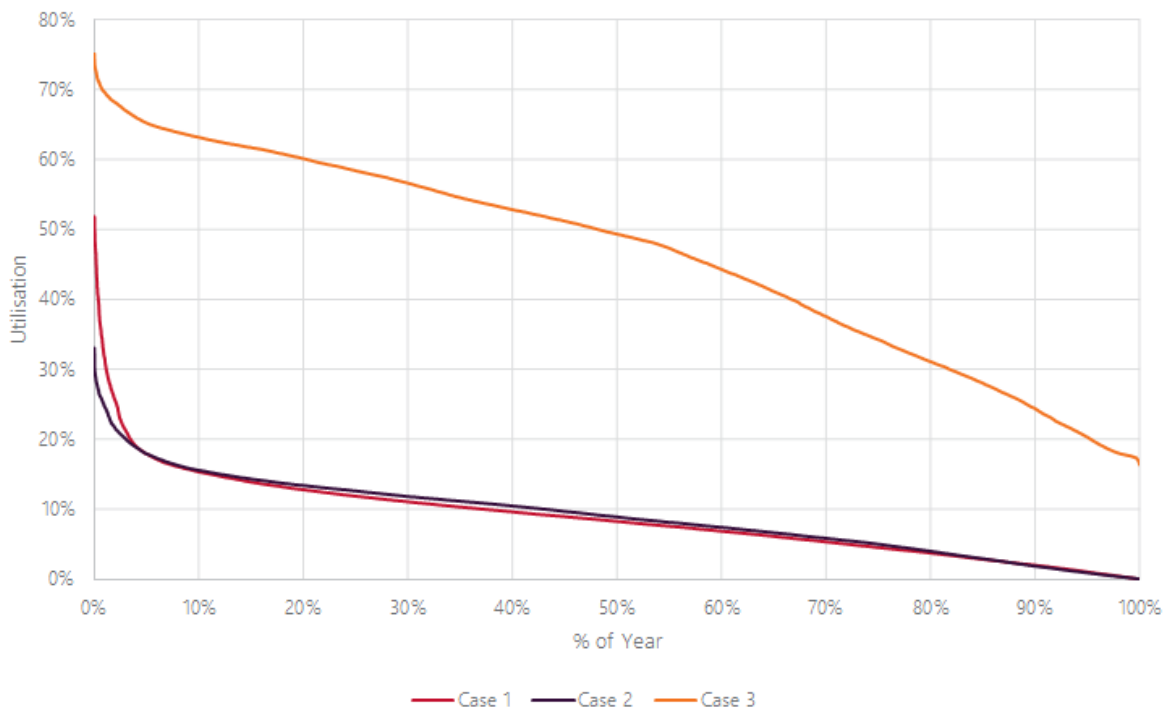

Figure 37 shows that with the 500 kV and 220 kV networks operated in parallel, the loading on the HWPS-YPS 220 kV lines, under contingency conditions, is projected to exceed 100% of their ratings for up to 20% of the time for Case 3. In the radial cases, the HWPS-YPS 220 kV lines are effectively forming a bus tie between the

two ROTS 220 kV split buses if there is no additional generation connected at YPS or HWPS 200 kV Bus No. 5 and 6.

Figure 37 HWPS – YPS 220 kV line load (under contingency) duration curve

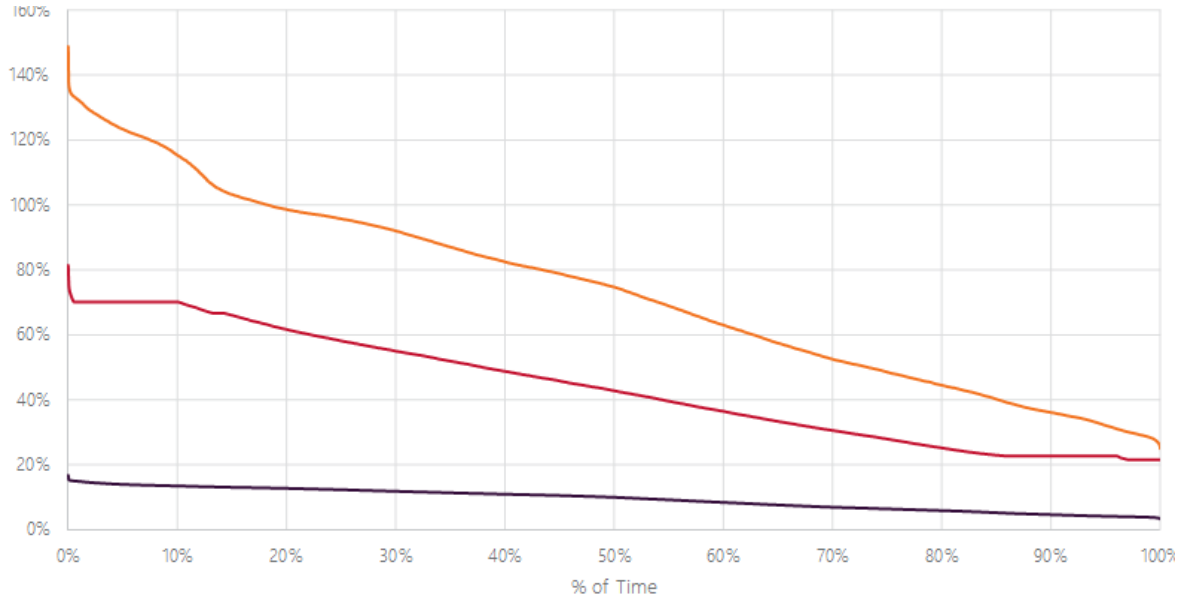
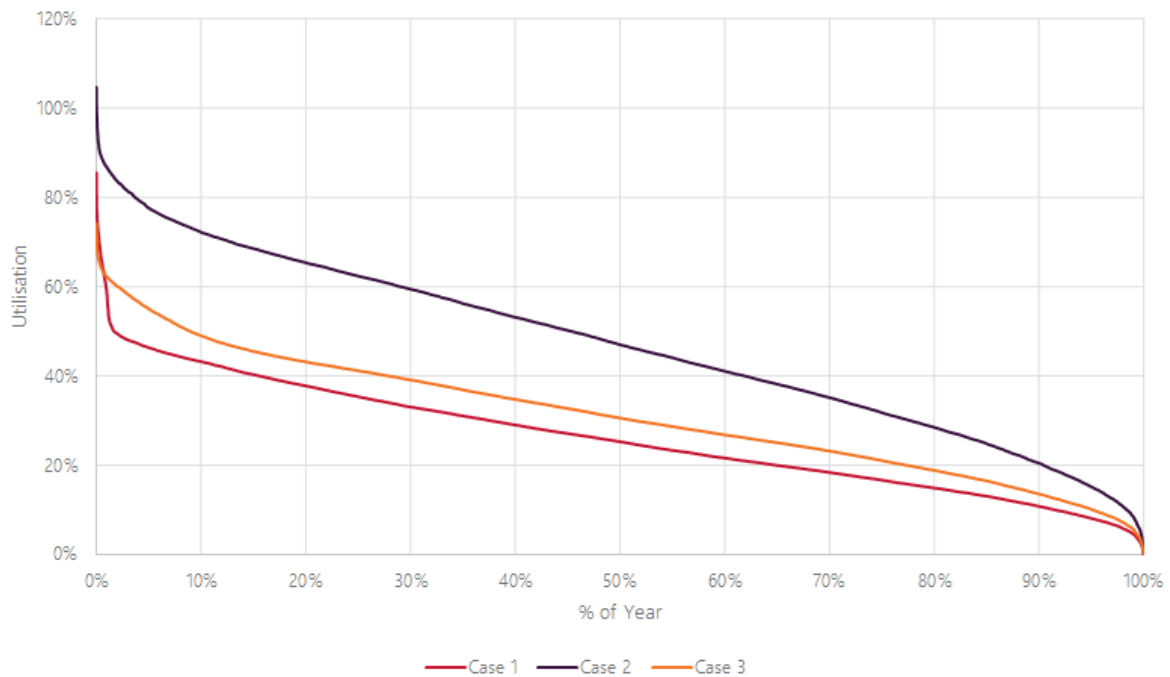

Figure 38 shows with the 500 kV and 220 kV operated radially, the loading on the RWTS-TTS 220 kV line, under contingency, is projected to exceed its rating for a small period of time (Case 2). In parallel mode (Case 3), the loading on the line is projected to remain within its rating.

Figure 38 RWTS – TTS 220 kV line load (under contingency) duration curve



Similar to the RWTS-TTS 220 kV line, the loading on the TSTS-TTS 220 kV line is projected to exceed its rating in radial mode (Case 2) while in parallel mode (Case 3) the loading on the lines is projected to remain within its rating.

Figure 39 TSTS – TTS 220 kV line load (under contingency) duration curve

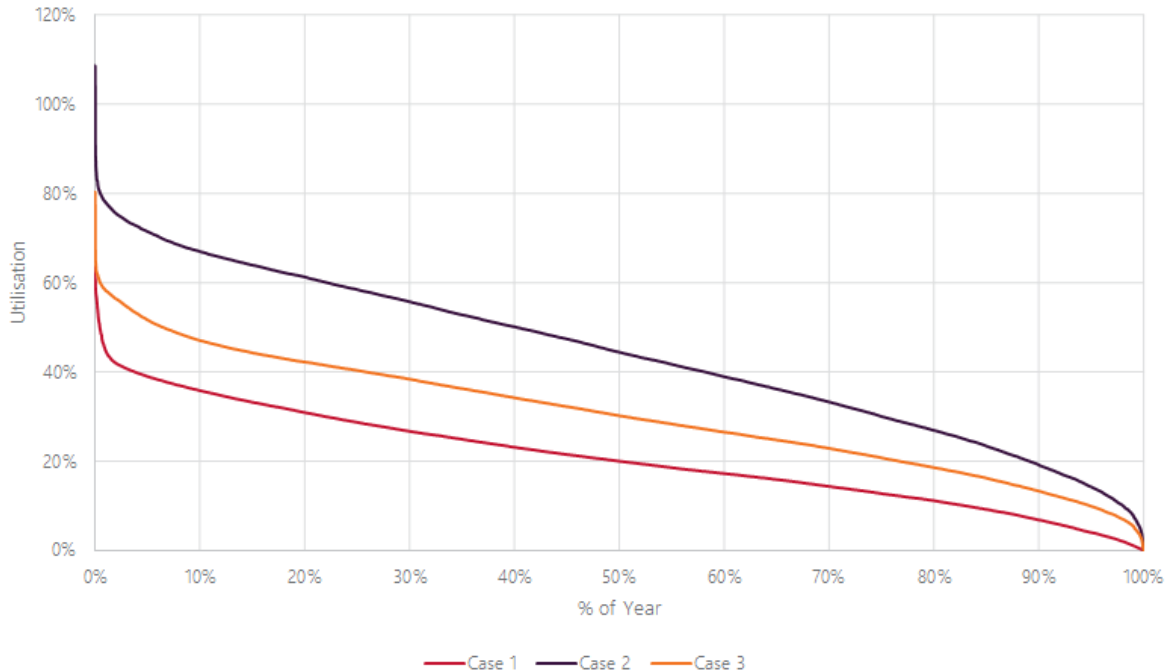

4.6.4 Supply reliability

The 2021 ESOO has forecast the reliability gap for Victoria, based on existing and committed projects¹⁰⁰, to be 390 MW by 2030-31 as a result of the retirement of YPS. A number of anticipated and proposed developments are likely to fill this gap. This includes new renewable generation (26.5 GW of additional generation is proposed), large-scale batteries (such as the Jeeralang Battery), and transmission network investments including VNI West and Marinus Link (discussed further in Section 3.3).

AEMO is also investigating further opportunities to mitigate against a potential reliability gap, including options to unlock Victorian generation by investing in solutions that relieve identified limitations.

Table 17 highlights the identified limitations in the DSN for which solutions could unlock generation in Victorian REZs to deliver the additional supply to load centres in the Greater Melbourne area.

RDP Stage 1 includes a number of projects that already seek to address some of the limitations above. Further information on the limitations, such as the associated trigger and potential network augmentation, is in Appendix A2.

¹⁰⁰ For assumptions on projects considered, see https://aemo.com.au/-/media/files/electricity/nem/planning_and_forecasting/nem_esoo/2021/2021-nem-esoo.pdf.

Table 17 Unlocking new generation – limitations

REZ	REZ limitations	Intra-regional connector limitations	Greater Melbourne area limitations
Ovens Murray	<ul style="list-style-type: none"> • DDTS-MBTS 220 kV line • MBTS-EPS 220 kV lines • DDTS 330/220 kV transformer 	<ul style="list-style-type: none"> • Eildon – Thomastown 220 kV line 	<ul style="list-style-type: none"> • SMTS 330/220 kV transformers • SMTS-TTS 220 kV lines
Central North	<ul style="list-style-type: none"> • DDTS-GNTS-Shepparton Terminal Station (SHTS) 220 kV lines • DDTS- SHTS 220 kV lines 		<ul style="list-style-type: none"> • Moorabool Terminal Station (MLTS) 500/220 kV transformer • MLTS-GTS-KTS 220 kV lines
Murray River	<ul style="list-style-type: none"> • RCTS-WETS-KGTS 220 kV line • Local voltage instability/collapse 		<ul style="list-style-type: none"> • Sydenham Terminal Station (SYTS)-KTS 500 kV line
Western Victoria	<ul style="list-style-type: none"> • RCTS-KMETS-MRTS-HOTS-BGTS 220 kV line 		
South West Victoria	<ul style="list-style-type: none"> • BATS-Berrybank Terminal Station (BBTS)-TGTS-MLTS 220 kV line • MOPS/TRTS-HYTS 500 kV lines • Local voltage collapse 	<ul style="list-style-type: none"> • MOPS-MLTS 500 kV line • TRTS-HGTS-MLTS 500 kV line 	
Gippsland	<ul style="list-style-type: none"> • HWTS- LYPS 500 kV line 	<ul style="list-style-type: none"> • HWPS-ROTS 220 kV line • HWPS-YPS 220 kV line • YPS-ROTS 220 kV line 	<ul style="list-style-type: none"> • CBTS 500/220 kV transformer • ROTTS 500/220 kV transformers • RWTS-TSTS 220 kV line • TSTS-TTS 220 kV line

Outage window

Following the retirement of Hazelwood Power Station in 2017, maintaining the Victorian supply-demand balance has become an operational challenge under conditions with low renewable generation, particularly when any of the existing three 500 kV Loy Yang – Hazelwood lines are out of service. During a prior outage of a 500 kV Loy Yang – Hazelwood line, the generators connected at or east of Loy Yang and Basslink importing into Victoria, about 4,000 MW in total, may need to be heavily constrained to maintain security.

This operational challenge has in turn impacted the available planned outage window for maintaining the Loy Yang – Hazelwood 500 kV lines. The planned outage would need to be scheduled during periods when the Victorian demand is below a pre-calculated threshold level to maintain a supply-demand balance post-contingency. This threshold level for planning outages of the Loy Yang – Hazelwood 500 kV lines depends on the availability of renewable generation, synchronous generation and BESS connected west of Loy Yang, as well as imports into Victoria from South Australia and New South Wales, and the acceptable amount of load shedding.

Under system normal conditions with all synchronous generation (except Newport Power Station), BESS, and interconnectors in service, the current threshold level is assessed to be approximately 6,000 MW. This considers conservative assumptions that no renewable generation is available and no post-contingent load shedding is acceptable.

While this has been an operational challenge at times, the necessary outages have been able to proceed without causing any security or reliability event.

The retirement of YPS itself will reduce the threshold demand level by about 1,500 MW. While the reduction could be partially compensated by the announced Jeeralang, it could result in increased challenges for scheduling planning outages.

As proper maintenance of DSN assets is essential for the network to perform to the required standard, and outages are also necessary for DSN modifications, there may be a need for investment to provide sufficient outage window after the retirement of YPS, scheduled in 2028.

As part of this VAPR, AEMO has performed a preliminary assessment of this need, which indicated that investment is unlikely to be justified through the regulatory process at this time. This conclusion is based on the expectation that the impact of YPS retirement will be offset by committed/anticipated projects which are expected to be commissioned by 2028. Operational measures, including post-contingent load shedding, will still be available to provide sufficient outage windows. The forecast threshold demand level in 2028, after the retirement of YPS, is estimated to be over 7,500 MW under system normal condition, considering the committed network augmentations presented in Chapter 3 and the 350 MW Jeeralang BESS project, assuming average generation from renewable generation and post-contingent load shedding up to 600 MW¹⁰¹.

4.6.5 Next steps

The retirement of YPS will require significant changes to the Victorian network to ensure system reliability and security is maintained. AEMO will continue to investigate into the impact of the YPS retirement and will:

- Identify the optimal DSN configuration after YPS retirement, considering potential future connections to the Latrobe Valley DSN, considering thermal, voltage control, stability, system strength and fault level implications.
- Further investigate the impact of the mode of operation on voltage stability and transient stability.

4.7 Power System Frequency Risk Review (PSFRR)

The PSFRR is a periodic review of power system frequency risks associated with non-credible contingency events in the NEM. AEMO, in its role as NEM Operator, undertakes this review in consultation with each of the TNSPs. The review considers:

- Non-credible contingency events which AEMO expects could likely involve uncontrolled frequency changes leading to cascading outages or major supply disruptions.
- Current arrangements for managing such non-credible contingency events.
- Options for future management of such events.
- The performance of existing Emergency Frequency Control Schemes (EFCs).

The findings from the 2020 PSFRR stage 1 report published in July 2020 were summarised in the 2020 VAPR. The 2020 PSFRR Stage 2 report, published in December 2020, recommended that AEMO, in its role as the Victorian Jurisdictional Planning Body, investigate various frequency performance issues which could be related to the Emergency Alcoa Portland Tripping Scheme (EAPT), the Interconnector Emergency Control Scheme (IECS,) including the new SIPS, and the Victorian Under Frequency Load Shedding Scheme (UFLS).

Further information on the PSFRR process, stages, and next steps are available on the AEMO website¹⁰².

Emergency Alcoa Portland [APD] Tripping Scheme (EAPT)

PSFRR 2020 Stage 2 recommended that AEMO:

¹⁰¹ This is indicative only, as the amount of load can be shed to return the system to a secure state within 30 minutes will depend on real-time operating conditions. AEMO Operations will also allow an outage to proceed with the risk of post-contingent load shedding only if it is critical and cannot be rescheduled.

¹⁰² See <https://aemo.com.au/en/energy-systems/electricity/national-electricity-market-nem/system-operations/power-system-frequency-risk-review>.

- Study the impact of recently connected renewable generation in South West Victoria on frequency should a separation of Victoria and South Australia occur west of MLTS and investigate the feasibility of using EAPT to address that impact.
- Investigate the operation and interaction of the scheme with IECS from a frequency control perspective.
- Investigate the co-ordination of EAPT and UFLS to better manage frequency.

EAPT was originally designed to trip APD to avoid voltage and frequency issues arising from the non-credible contingencies that results in APD load being supplied from South Australia. AEMO recently completed several reviews of EAPT in response to a mal-operation event in 2018 and also as part of an impact assessment of recent network changes. As a result, setting changes have been implemented to minimise the risk of future mal-operation, and recommendations have been made to further modify the scheme to improve its reliability. Other findings from the AEMO EAPT review include:

- It is inappropriate to modify the EAPT to address frequency performance issue introduced by high generation along the HYTS to MLTS lines. AEMO's preferred solution to address generation-driven issue is to trip or runback generation, not to trip APD load. It should be noted that all existing generation connected along the line, with the exception of Macarthur Wind Farm, would be tripped should separation from MLTS occur, which could be sufficient in addressing any issue driven by renewable generation connected to South West Victoria.
- The reliability of the existing EAPT scheme could be greatly improved by changing its contingency detection from a performance-based approach to a topology-based approach. This is in line with the *Final Report – Queensland and South Australia system separation on 25 August 2018* and PSFRR recommendation to avoid mal-operation due to unexpected interaction with IECS.
- With the use of the topology-based contingency detection, the response time of the scheme will be minimised, which will address the high RoCoF issue identified in the PSFRR, and also improve coordination between EAPT and UFLS as recommended by PSFRR.

AEMO will investigate if necessary, jointly with ElectraNet, possible new control schemes to address any high generation-driven issues.

AEMO will continue to monitor the latest changes in the area and will assess the need to further modify the EAPT accordingly.

Interconnector Emergency Control Scheme (IECS)

PSFRR 2020 Stage 2 has recommended that AEMO:

- Investigate the interaction and coordination between IECS and UFLS, under the low probability operating conditions which IECS operation may be insufficient to prevent Victoria and New South Wales separation.
- Assess the ability of the VBB to address non-credible contingency event impacts.

The IECS has been designed to respond quickly to multiple simultaneous transmission line contingencies by tripping selected load groups to prevent Victorian separation from the rest of NEM due to instability. This would mitigate the need to activate UFLS which will trip more load from the system.

However, the effectiveness of the IECS in preventing Victorian separation is limited by the physical limitations such as the speed of load shedding. Under certain low probability extreme operating conditions, it may not be able to avoid instability (power swings) that will trigger line protection, causing cascade tripping and Victorian separation, irrespective of the amount of load tripped. Under these operating conditions, UFLS will subsequently activate independently to manage frequency and restore stability.

The IECS will also trip a select group of generators to minimise the increase in frequency following the tripping of the selected load group. This is done to reduce the risk of generators tripping on over-frequency protection therefore critical for maintaining stability.

AEMO has recently reviewed the IECS and recommended that more load blocks be included into the selected load groups to be tripped by IECS. This is done to offset the impact of increased rooftop PV and distributed generation by ensuring sufficient amount of load is available to be tripped by the IECS.

AEMO also considered the recommendations from PSFRR, and found:

- There is no adverse interaction between IECS and UFLS (see the next section for more information about UFLS).
- It is acceptable that IECS operation may be insufficient to prevent Victoria and New South Wales separation during low probability operating conditions. This is aligned with the purpose of the IECS which is to reduce the risk of separation.
- There is currently no plan to develop new control scheme to manage non-credible contingency events as such a need has not been identified. AEMO will continuously assess the need for new control schemes and explore available options to minimise impact of contingencies on DSN performance.

Under Frequency Load Shedding Scheme (UFLS)

PSFRR 2020 Stage 2 has recommended that AEMO review the design of existing UFLS schemes to ensure effectiveness and avoid UFLS trip of back-feeding distribution feeders.

AEMO is currently progressing a NEM mainland UFLS review that is expected to be completed in Q4 2021, consistent with the above recommendation.

AEMO has separately published a Phase 1 report¹⁰³ into the state of the UFLS scheme in Victoria. The report noted that the total minimum load available to the UFLS scheme has decreased from 1,926 MW in 2019 to 1,273 MW in 2020. This trend is expected to continue with the minimum load available estimated to be 500 MW by late 2023 due to increasing penetration of distributed PV. This will impact the effectiveness of the UFLS scheme.

The report has recommended various steps to improve the effectiveness of the UFLS. Phase 2 of the report will be published to inform the scale and urgency for remediating the issues identified.

AEMO as the Victorian TNSP is closely assessing the recommendations.

4.8 Victorian control schemes

As first outlined in the 2019 VAPR, AEMO has now reviewed all existing system protection and control schemes that were in operation across the Victorian DSN before 2019. Through this process, AEMO has identified a number of control schemes that warrant variations to accommodate recent changes in local operating conditions and network configurations. AEMO is progressing with the implementation of these modifications, like the Murraylink Very Fast Runback Scheme changes as highlighted in Section 3.3.7.

The RDP Stage 1 is considering the implementation of a number of control schemes to unlock generation. AEMO will also continue to monitor changes to the network and where investigation into changes or new control schemes would be required.

4.9 Distribution planning

AEMO reviews DNSP plans for existing and new connection points and, where relevant, incorporates the impact of any distribution network modifications in its transmission planning work. AEMO and DNSPs work together to resolve connection asset limitations, and this cooperation ensures a co-optimised and efficient solution for both the distribution network and the DSN. Appendix A1 includes information on constraints and augmentations identified in the 2020 Transmission Connection Planning Report, prepared by the Victorian DNSPs.

¹⁰³ See <https://aemo.com.au/-/media/files/initiatives/der/2021/vic-ufls-data-report-public-aug-21.pdf>

5. Asset replacement and retirements in the DSN

This chapter addresses NER requirements related to DSN asset retirement, deratings, and replacement.

Key asset replacement insights

While previous chapters have focused on the need for network augmentation, appropriate maintenance of Victoria's existing network asset base remains critical. In 2021, AEMO has again worked closely with AusNet Services to assess the need for the replacement, refurbishment, derating, or retirement of existing assets that are approaching end-of-life.

In the 2021 VAPR:

- AusNet Services' 2021 asset replacement and refurbishment plans are largely consistent with those presented in the 2020 VAPR.
- Several new asset replacement projects have been identified, or have now moved within the assessment horizon, including:
 - Heywood – Alcoa Portland T627 to T628B tower replacement.
 - Murray – Dederang 330 kV No. 1 and No. 2 tower upgrades.
 - SHTS transformer and circuit breaker replacement.
 - KTS A4 500/220 kV transformer and circuit breaker replacement.
 - Loy Yang Power Station 66 kV switch yard circuit breaker replacement.
 - Morwell Terminal Station 66 kV circuit breaker replacement.
 - Hazelwood Terminal Station A2, A3, and A4 500/220 kV transformer replacement.
 - YPS 220 kV circuit breaker Stage 2 replacement.
 - Wodonga Terminal Station 330 kV and 66 kV circuit breaker replacement.
 - Newport Power Station switchyard 220 kV gas insulated switchgear (GIS) switch bays replacement.
- Conversely, the following asset replacement projects have been removed or moved beyond the assessment horizon, including:
 - Replacement of the 66 kV and 220 kV circuit breakers for reactive plants at Keilor, Rowville, Fishermans Bend, Moorabool, and Thomastown.
 - Bendigo – Kerang 220 kV transmission line replacement.
- For each project, AEMO has analysed future system needs and confirmed the underlying system impact that would arise if the existing asset was removed without replacement. This analysis identified a continuing system need associated with most of the proposed asset replacement projects.

The chapter also includes an update on the status of the current asset replacement RIT-T projects. AusNet Services have completed RIT-T assessments for three asset renewal projects and the PADR or PACR has been published for another three projects.

5.1 Rule requirements

Due to aging transmission assets, changes in technology, and slowing demand growth, there is an increasing need to coordinate DSN asset renewal and augmentation activities in Victoria, and to assess both the system need and economic justification for replacement of existing assets.

In Victoria, AusNet Services is responsible for assessing the condition of its Victorian DSN assets, and for making replacement, retirement, or derating decisions for these assets.

As the Jurisdictional Planning Body (JPB) for Victoria, AEMO's involvement is primarily in providing planning advice to AusNet Services (particularly on the continued system need for individual DSN assets). Under NER clause 5.12.2, regional Transmission Annual Planning Reports (TAPRs) must include detailed information relating to all network asset retirements and deratings that would result in a network constraint over the planning period. AusNet Services' current asset renewal plan is available alongside the VAPR on the AEMO website¹⁰⁴.

Under NER clause 5.14.1, where there is an identified need to retain an asset, AEMO and AusNet Services conduct joint planning to identify the most efficient and economic option to address the identified need. The following sections provides more information about the joint planning process for asset retirement, replacement, refurbishment, and deratings.

5.2 Methodology

AEMO and AusNet Services agreed an approach for joint planning which was adopted in this VAPR:

- AEMO and AusNet Services jointly selected a set of assets which are included in AusNet Services' Asset Renewal Plan and are likely to create a DSN constraint which potentially justifies a RIT-T for replacement.
 - The selected assets were grouped with their associated network components whenever possible, and a need assessment was conducted by assessing the overall network impacts of retiring the asset.
 - Circuit breakers, other switchgear, and secondary systems were grouped with their respective associated network components, such as transmission circuits, transformers, generators, or reactive plant whenever possible. For example, if a line circuit breaker is retired, then its associated transmission circuit should also be considered as unavailable for service in assessing the system impact of the circuit breaker retirement.
- Committed projects and transmission assets that do not form part of the DSN were excluded from the network need assessment.
- Most of the secondary equipment in the Asset Renewal Plan, including communication systems and control batteries, were excluded from the network need assessment for individual projects. These secondary systems are considered essential to the associated DSN primary network components, and therefore they will be needed as long as the associated primary network components are still in services. As there is no committed retirement of Victorian transmission lines and Victorian interconnectors at present, AEMO and AusNet Services agreed that all secondary equipment associated with the Victorian transmission lines and interconnectors are still needed, without carrying out need assessment on individual projects involving secondary equipment.

¹⁰⁴ At <https://aemo.com.au/en/energy-systems/electricity/national-electricity-market-nem/nem-forecasting-and-planning/victorian-planning/victorian-annual-planning-report>.

- AEMO undertook a desktop analysis to assess whether the retirement of the selected asset would result in a network impact (that is, a network need for its replacement). In the case of an asset retirement causing disconnection of a generator, the resulting reduction in supply availability was also considered.
- If the proposed retirements would cause line, transformer, or SVC outages, the impact of a credible contingency under worst-case operational conditions (normally either maximum or minimum demand conditions) was examined with a prior outage of the respective network element.

5.3 Needs assessment results

Table 18 presents the summarised findings from the assets needs assessment. Several new assessments were conducted as part of the VAPR 2021, including:

- Heywood – Alcoa Portland T627 to T628B tower replacement.
- Murray – Dederang 330 kV No. 1 and No. 2 tower upgrades.
- SHTS transformer and circuit breaker replacement.
- KTS A4 500/220 kV transformer and circuit breaker replacement.
- Loy Yang Power Station 66 kV switch yard circuit breaker replacement.
- Morwell Terminal Station 66 kV circuit breaker replacement.
- Hazelwood Terminal Station A2, A3, and A4 500/ 220 kV transformer replacement.
- YPS 220 kV circuit breaker replacement Stage 2.
- Wodonga Terminal Station 330 kV and 66 kV circuit breaker replacement.
- Newport Power Station switchyard 220 kV GIS switch bays replacement.

Table 18 Network need assessment results

Project name	Location	Total cost (real \$M)	Target completion date	Major DSN assets component(s)	Retirement outcome
Horsham SVC Replacement	Horsham	2	2024	Horsham 220 kV SVC	Voltage cannot be maintained within limits. Reduced Murraylink export during outage of Western Victorian 220 kV lines. Potential restriction on local generation.
Heywood – Alcoa Portland T627 to T628B Tower Replacement (New in 2021 VAPR)	Heywood, Alcoa Portland	7	2024	Heywood – Alcoa Portland lines No. 1 and No. 2	Loss of connection to Alcoa Portland.
Murray – Dederang 330 kV No. 1 and No. 2 Tower Upgrades (New in 2021 VAPR)	Murray, Dederang	7	2025	Murray – Dederang 330 kV lines No. 1 and No. 2	Reduced Victoria DSN capacity and transfer capability between NSW and Vic, thus supply reliability.
Sydenham 500 kV GIS Replacement	Sydenham	81	2025	Sydenham – Moorabool 500 kV No. 1/No. 2 lines breaker-and-half switch bay	Reduced reliability caused by system separation due to a single credible contingency and reduction in VNI interconnector capability
				Sydenham – South Morang 500 kV No. 1/No. 2 lines breaker-and-half switch bay	Reduced interconnector and Western Vic Renewable Integration capabilities
				Sydenham – Keilor 500 kV Line breaker-and-half switch bay	Reduced reliability and capability to meet peak demand. Reduced interconnector capabilities.
Shepparton Terminal Station Transformer ¹⁰⁵ and Circuit Breaker Replacement (New in 2021 VAPR)	Shepparton	39	2026	Shepparton Terminal Station capacitors 2A, 2B,3A and 3B capacitor bank circuit breakers	Reduced reactive power capability to manage voltages. ^A

¹⁰⁵ Shepparton transformer is not part of the DSN, hence not considered in the needs assessment study

Project name	Location	Total cost (real \$M)	Target completion date	Major DSN assets component(s)	Retirement outcome
Moorabool Terminal Station Circuit Breaker Replacement	Moorabool	28	2026	Moorabool – Tarrone 500 kV No. 1 line, Moorabool – Sydenham 500 kV No. 1 line and 500 kV Reactor No.1	Reduced reliability caused by system separation due to a single credible contingency. Reduced Vic-SA transfer capability.
				Moorabool – Mortlake 500 kV No. 2 line, Moorabool – Sydenham 500 kV No. 2 line and 500 kV Reactor No. 2	Reduced reliability caused by system separation due to a single credible contingency. Reduced Vic-SA transfer capability.
				Moorabool A1 500/220 kV transformer and Moorabool – Geelong No. 2 line	Reduced reliability and capability to meet peak demand.
				Moorabool A2 500/220 kV transformer and Moorabool – Geelong No. 1 line	Reduced reliability and capability to meet peak demand.
				Moorabool – Ballarat 220 kV No. 2 line	Western Victorian generation constrained and reduced reliability.
				Moorabool – Ballarat 220 kV No. 1 and Moorabool – Terang 220 kV line	Western Victorian generation constrained and reduced reliability. Reduced reliability caused by partial loss of terminal station due to a single credible contingency.
				Moorabool 220 kV reactor No. 1	Voltage cannot be maintained within limits
Keilor Terminal Station A4 500/220 kV Transformer and Circuit Breaker Replacement (New in 2021 VAPR)	Keilor	71	2026	Keilor A2/A3 750 MVA 500/220 kV transformer	Reduced reliability and capability to meet peak demand under certain operating conditions. ^B
				Keilor 220 kV capacitor bank No. 1 and Keilor 66 kV capacitor bank 1B	May reduce maximum supportable demand caused by reduced reactive power margin. ^C

Project name	Location	Total cost (real \$M)	Target completion date	Major DSN assets component(s)	Retirement outcome
South Morang 330/220 kV Transformer Replacement – Stage 2 (One 700 MVA 330/220 kV transformer)	South Morang	44	2026	South Morang 330/220 kV H1 transformer	Reduced reliability and capability to meet peak demand.
South Morang 500 kV GIS Replacement – Stage 1	South Morang	18	2026	South Morang – Hazelwood 500 kV No. 1 Line breaker-and-half switch bay	Reduced reliability and interconnector capabilities
				South Morang – Sydenham 500 kV No. 1 Line breaker-and-half switch bay	Reduced interconnector capabilities
Thomastown Circuit Breaker Replacement	Thomastown	19	2028	Thomastown 220 kV No.1 and 66 kV 4B capacitor bank circuit breakers	May reduce maximum supportable demand caused by reduced reactive power margin. ^C
Loy Yang Power Station and Hazelwood 500 kV Circuit Breaker Replacement Stage 2	Loy Yang Power Station	60	2028	Loy Yang – Hazelwood 500 kV No. 1 line double breaker switch bay	Generation constraints and reduced reliability.
	Hazelwood			Loy Yang – Hazelwood 500 kV No. 2 line	Generation constraints and reduced reliability.
				Loy Yang – Hazelwood 500 kV No. 3 line	Generation constraints and reduced reliability.
				Hazelwood – Loy Yang 500 kV No. 2 line and Hazelwood – Rowville 500 kV No. 3 line breaker-and-half switch bay (Hazelwood end)	Generation constraints and reduced reliability.
				Hazelwood – Loy Yang 500 kV No. 3 line and Hazelwood – Cranbourne 500 kV No. 4 line breaker-and-half switch bay (Hazelwood end)	Generation constraints and reduced reliability.
Loy Yang 66 kV Circuit Breaker Replacement (New in 2021 VAPR)	Loy Yang (LY) 66 kV Switch Yard	14	2030	Loy Yang – Morwell 66 kV line No. 1,2,3 and 4 and Loy Yang 66 kV capacitor banks No.1 and No.2	Loss of supply for emergency fire services.

Project name	Location	Total cost (real \$M)	Target completion date	Major DSN assets component(s)	Retirement outcome
Morwell Terminal Station 66 kV Circuit Breaker Replacement (New in 2021 VAPR)	Morwell Terminal Station	6	2030	Morwell to Loy Yang 66 kV line No. 3 and No.4	Loss of supply for emergency fire services.
Hazelwood A2, A3 and A4 Transformer Replacement (New in 2021 VAPR)	Hazelwood Terminal Station (HWTS)	45	2030	Hazelwood A2, A3 and A4 500/220 kV transformers	Reduced reliability and capability to supply Melbourne eastern metro load. ^D
Yallourn 220 kV Circuit Breaker Replacement Stage 2 (New in 2021 VAPR)	Yallourn Power Station (YPS) Switchyard	10	2030	Yallourn – Rowville 220 kV lines No. 5 and No.6 and Yallourn – Hazelwood 220 kV lines No. 1 and No. 2	Reduced reliability and capability to supply Melbourne eastern metro load. ^E
Wodonga 330 kV and 66 kV Circuit Breaker Replacement (New in 2021 VAPR)	Wodonga Terminal Station (WOTS)	13	2030	Wodonga – Dederang 330 kV line / Wodonga – Jindera 330 kV line	Reduced Victoria DSN capacity and Vic – NSW interconnector capabilities.
Newport 220 kV GIS (New in 2021 VAPR)	Newport Power Station Switchyard (NPSD)	43	2030	Newport – Brooklyn 220 kV line / Newport – Fishermans Bend- 220 kV line	Loss connection to Newport generation.

- A. Based on AEMO Transmission Connection Point Forecasts for Victoria -Dynamic Interface December 2020, not all capacitors are required to be in service under peak demand conditions to keep 66 kV voltage within limits. However, it is noted that DNSP's forecast as published in the 2020 Transmission Connection Point Report (TCPR) is significantly higher than AEMO's forecast.
- B. AusNet Services and AEMO will continuously work together to determine the preferred option in replacing the existing Keilor transformers.
- C. In addition to maximum supportable demand, AEMO also assessed the impact of in-service 220 kV or 66 kV cap banks on Victorian import voltage stability limits and voltage control. Studies results indicated that retiring any existing capacitor bank could reduce the Victorian import voltage stability limit from New South Wales, however not all capacitor banks are required to be in-service at the same time for voltage control. Further studies using a voltage stability assessment tool (VSAT) has also confirmed the impact of these capacitor banks on Victorian import voltage stability limit. The retirement impacts of capacitor bank circuit breakers and their associated capacitor banks are inter-dependent.
- D. The need for Hazelwood A2, A3, and A4 transformers is dependent on future generation market dispatch in the Latrobe Valley or further east. Hazelwood transformation allows continued utilisation of Latrobe Valley to Melbourne 220 kV lines to supply Melbourne eastern metro load. Major generation connection at Hazelwood may require Hazelwood transformation to connect to the 500 kV network any portion of this generation not transmitted to Melbourne at 220 kV
- E. Hazelwood transformation allows continued utilisation of Latrobe Valley to Melbourne 220 kV lines to supply Melbourne eastern metro load.

5.4 Asset renewal Regulatory Investment Test projects

AusNet Services has completed RIT-T assessments on the following asset renewal projects since publication of the 2020 VAPR:

- East Rowville Terminal Station (ERTS) Redevelopment – Stage 2.
- Templestowe Terminal Station (TSTS) Transformer and 66 kV Circuit Breaker Replacement.
- Brooklyn Terminal Station (BLTS) 66 kV Circuit Breaker Replacement.

The following asset renewal project RIT-Ts have progressed.

- Horsham (HOTS) SVC Replacement (PADR published).
- SYTS 500 kV GIS Replacement. (PADR published).
- SHTS Transformer and Circuit Breaker Replacement (PACR published).

More details are in AusNet Services' current asset renewal plan, which is available with the VAPR on AEMO's website¹⁰⁶.

¹⁰⁶ At <https://aemo.com.au/en/energy-systems/electricity/national-electricity-market-nem/nem-forecasting-and-planning/victorian-planning/victorian-annual-planning-report>.

6. Adapting to the future network

This chapter sets out how continued renewable investment, especially in areas with high quality resources and weak network, could impact the required transmission build for Victoria. It identifies potential projects that could progress through the regulatory process if threshold trigger conditions were to occur, or that could be available for third-party investment outside of the existing regulatory framework.

AEMO's *Transmission Development Plan for Victoria* set out projects that are expected to relieve network limitations and deliver net market benefits under the current regulatory framework, which assumes new generators locate on the network according to a least cost optimised development approach. Locational signals such as network constraints, marginal loss factors (MLFs), and system strength levels, are used in the NEM to inform and incentivise investment to invest in areas of the network that are likely to provide most value to electricity consumers.

However, renewable development interest continues to exceed optimal development in weak network locations, where high-quality solar and wind resources are abundant. As these parts of the network were not originally designed to support such high generation density, investors continue to face economic and technical challenges associated with connection to these weaker parts of the grid.

Any investment in transmission infrastructure needs to carefully balance the needs and risks of both generators and consumers to ensure optimal economic outcomes and market benefits as a whole. If development is done well, developers will have access to robust network infrastructure that allows efficient use of local resources, and consumers will benefit from enhanced system security, reliability, and market competition.

Given the misalignment between least cost optimised and actual investment interest, coupled with the relative difference in construction lead times between generation and transmission investment, AEMO has undertaken the prudent measure to investigate and identify potential investments beyond the *Transmission Development Plan for Victoria*. While these investments are not currently expected to pass the RIT-T, third parties (including governments) can elect to fund these investments to help facilitate prospective connections and minimise generator curtailment in the absence of a regulated investment.

AEMO has been directed by the Victorian Government to undertake procurement processes to progress three contestable projects for services to strengthen the system as well as three sets of non-contestable minor network augmentations. If committed to by the Victorian Government, the services to strengthen the system aim to increase the capability of the system to remain stable with connection of up to 1,500 MW of additional generation capacity, while the minor augmentations are expected to increase average REZ hosting capacity by 205 MW across three REZs.

New technology will be a key driver in the energy transition. As outlined in AEMO's *Application of Advanced Grid-scale Inverters in the NEM* white paper, studies suggest that a BESS behind a grid-forming inverter has the potential to stabilise the grid to comparable levels of a similar capacity (MVA) synchronous condenser.

6.1 Introduction

As the system changes, AEMO must continue to adapt its regional planning processes to keep pace. These adaptations are occurring across a spectrum of challenging issues, in particular:

- **Changing supply mix** – investment interest in Victoria remains high, with many large-scale renewable generator and battery connections projects in the pipeline, resulting in rapidly changing patterns of network flow and asset utilisation.
- **Planning beyond the Transmission Development Plan** – the misalignment between forecast and actual investment interest means AEMO needs to identify potential network investments that, while not currently expected to pass the RIT-T in the 10-year planning horizon, could be justified if more generation is likely to be connected.
- **Government and third-party funded investments** – third parties including governments are choosing to invest in projects, including DSN assets, to minimise connection risk and help drive the renewables transition. AEMO is adapting its planning and consideration of third-party investments to integrate such investments in a coordinated manner to complement the *Transmission Development Plan for Victoria* without compromising the integrity of the DSN.
- **Adapting to changing connection needs** – connection processes and modelling activities are being improved to provide clear communication channels, transparent milestones, and more personalised account management.
- **Adapting to new technologies** – emerging technologies need to be understood to allow even-handed consideration alongside network options in all planning processes.

The following sections explore each of these categories in more detail, and identify several initiatives and activities AEMO is undertaking in each category.

6.2 Changing supply mix

Patterns of network flow and asset utilisation are changing rapidly in response to strong investor interest in renewable generation projects, and strong consumer interest in distributed PV. This section presents an overview of generator connection interest in Victoria, noting significant growth in both existing and proposed levels of renewable generation.

Many of these new projects are proposed in western parts of the state, where high-quality solar and wind resources are abundant. However, these parts of the network were not originally designed to support such high connection density, and as investors continue to face economic and technical challenges associated with connection to these weaker parts of the grid they are increasingly looking to invest in other areas of Victoria.

Victorian connections pipeline

Investment interest in Victoria remains high, with many large-scale renewable generator and battery connections projects in the pipeline, along with some gas generator interest, as shown in Figure 40¹⁰⁷.

Compared to the projects reported in the 2020 VAPR, interest has backed off in the Murray River and Western Victorian REZs, where hosting capacity is full, but has increased in all other REZs except for Central North, which has decreased interest by approximately 1 GW. Marked increased interest has also been seen in Metro Melbourne, particularly in new battery connection interest, with connections interest up around 2 GW compared to the pipeline reported in the 2020 VAPR.

¹⁰⁷ The Victorian connections pipeline includes proposed battery or generator connections to either the Victorian transmission or distribution network that are at either the enquiry or application stage and have a proposed capacity of 5 MW or more.

Figure 40 Current Victorian connections pipeline

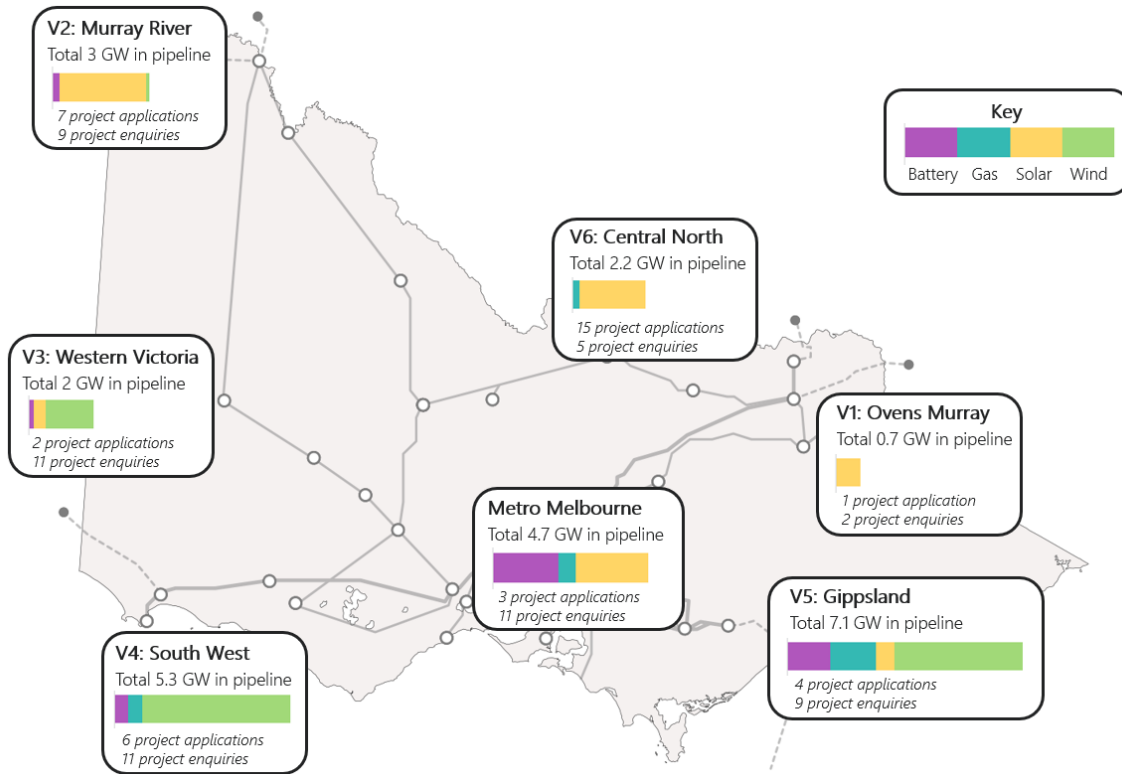

As at September 2021: <https://aemo.com.au/energy-systems/electricity/national-electricity-market-nem/participate-in-the-market/network-connections/nem-generation-maps>.

Figure 41 summarises the currently available hosting capacity in each REZ, as well as the expected additional hosting capacity from committed transmission investments. Committed transmission projects are listed in AEMO's *Transmission Development Plan for Victoria* (Section 3.3).

Figure 41 Summary of Victorian REZs

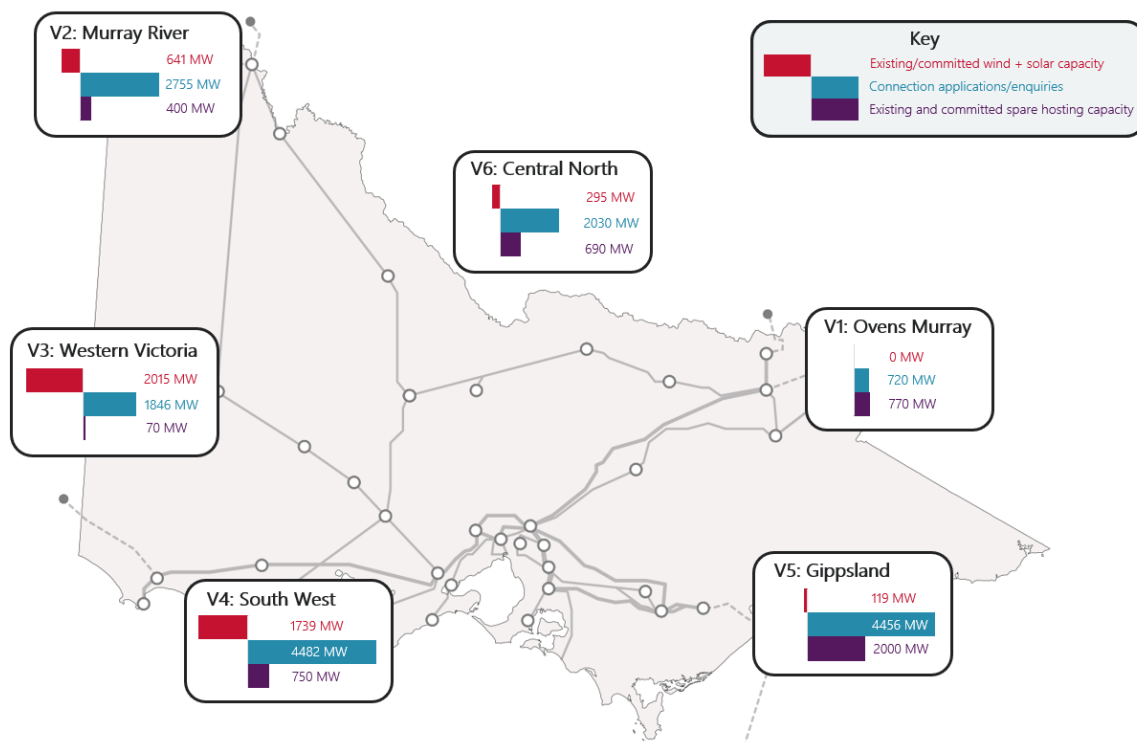

Existing hosting capacity values are based on the 2020 ISP and 2021 Transmission Cost Report, and have been updated to include newly committed generators. Applications and enquiries as at September 2021 from AEMO's Victoria connections map: <https://aemo.com.au/energy-systems/electricity/national-electricity-market-nem/participate-in-the-market/network-connections/nem-generation-maps>.

6.3 Planning beyond the Transmission Development Plan

AEMO's *Transmission Development Plan for Victoria* (see Section 3.3) includes all projects that are likely to deliver net economic benefits under the current regulatory framework. However, as Figure 40 and Figure 41 show, Metro Melbourne and all six REZs have an abundance of developer interest well in excess of the ISP's projected build and the existing and committed spare hosting capacity.

As a result, some hosting capacities, particularly in the Murray River REZ and Western Victoria REZ, are being exceeded, and new system constraints are emerging that result in delays to proponents achieving a connection, or curtailment of generators that do connect. In general, the regulatory framework assigns these risks directly to individual developers as 'locational investment signals', that should encourage investment in more optimal locations. However, other considerations may still lead to developers wanting to invest in locations that are less than optimal from a network health perspective.

Given the misalignment between optimal and actual investment interest, coupled with the relative difference in construction lead times between generation and transmission investment, AEMO has identified potential investments beyond the *Transmission Development Plan for Victoria*. While these investments are not currently expected to pass the RIT-T, AEMO has considered them in sensitivity analysis to inform stakeholders. Refer to section 6.4 for more information on government investments to facilitate prospective connections and minimise generator curtailment in the absence of regulated investment.

6.3.1 Unlocking REZ hosting capacity

Hosting capacity is the approximate maximum scale of additional generation (MW) that can be transported from a REZ to a load centre excluding system strength limitations. The hosting capacity in each REZ is determined considering a number of limiting factors, primarily:

- Thermal capacity – the power that can flow through a transmission line before the heat created causes irreversible asset damage or causes the line to sag dangerously close to its surrounding environment.
- Voltage stability – the power that can be sent across a transmission line with enough reactive power to maintain healthy voltages.
- Transient stability – the power that can be transferred between regions without unstable electromagnet decoupling following an event or contingency that weakens the connection between those regions.

These limitations must be managed during both system intact conditions and following the credible contingent loss of any generator, load, or transmission network element. How these factors limit the power that can flow in and out of REZs is complex and dynamic, changing from minute-to-minute with the level and location of load, ambient temperature, generator availability, and configuration of the network at the time.

Ways of alleviating constraints driven by these limitations include increasing the interconnectedness of the network, adding more sources of reactive power, and upgrading the physical transmission lines and network elements. Transmission investment projects that involve building additional lines most often improve all the limiting factors mentioned above. However, other investments, such as connecting new generation, installing reactive power support, and upgrading communication systems, might only address a specific limitation type.

For example, as detailed in Table 7, in the Murray River REZ, a NCIPAP project was completed in August 2021 by AusNet Services to allow dynamic windspeed and ambient temperature monitoring to be incorporated into thermal ratings of the transmission lines between Red Cliffs and Bendigo, allowing the thermal capacity of the Murray River REZ to be more fully utilised. However, the REZ hosting capacity will still be limited at times due to the increasing prevalence of voltage stability limitations in area (see Table 7 for constraint impacts in the Murray River in 2021).

6.3.2 System strength

Low system strength is another important factor limiting the connection of new generators. While system strength must be considered alongside hosting capacity, it is not itself considered a measure of hosting capacity because the current rules framework requires connecting generators to provide their own system strength services if the network does not provide it and connection to network cannot be made without sufficient system strength in place. System strength limitations can still emerge despite this framework due to:

- Retirement of existing system strength sources.
- Unexpected interactions of existing and/or new inverter-based generators located in proximity of each other.
- Temporary outage conditions that reduce the system strength available in the network.

Low system strength is predominately impacting generators in the Murray River and Western Victoria REZs, as detailed in Section 2.7. Low system strength is also limiting the provision of planned outages, particularly within the South West REZ, however this limitation is expected to be eased with the recent installation of four new synchronous condensers at Davenport and Robertson in South Australia.

6.3.3 REZ health and investment options

Appendix A4 of the 2020 VAPR highlighted a range of locational investment signals, as an information resource to interested parties, to provide guidance on optimal investment areas and constrained areas of the network. This included the geographic impact of existing thermal constraints, stability limitations, system strength requirements, and marginal loss factors. This section extends on the previous locational investment signals by identifying possible network solutions and their indicative cost and hosting capacity increase they are expected to be capable of delivering.

Ovens Murray REZ

The Ovens Murray REZ remains a low risk REZ for proposed connections, with existing spare hosting capacity and a strong average marginal loss factor.

Additionally, although not specifically designed to increase REZ hosting capacity, committed investments to increase VNI capacity will inherently increase the Ovens Murray REZ hosting capacity. These committed VNI investments include the SIPS and the Victoria – New South Wales Interconnector East (VNIE) project. Combined, these committed investments are expected to increase the Ovens Murray REZ hosting capacity by approximately 420 MW.

Table 19 Ovens Murray REZ health and investment options

V1 – Ovens Murray	Connection risk	Existing (with committed project) spare hosting capacity (MW)	Average 2021-22 MLF	Thermal constraints	Stability constraints	System strength
REZ Health	Low	350 (770)	Average	Capacity available	Capacity available	Average
Limitation	Possible network solutions				Indicative estimated cost (\$M)	Indicative hosting capacity increase (MW)
Dederang – Mount Beauty 220 kV line loading	Install a wind monitoring scheme				Cost to be determined	55
	Up-rate the conductor temperature of both 220 kV circuits between Dederang and Mount Beauty to 82°C				13.3	190
Mount Beauty – Eildon – Thomastown 220 kV line loading	Install wind monitoring scheme				Cost to be determined	80
	Up-rate Mount Beauty - Eildon – Thomastown 220 kV line, including terminations to 75 °C operation				114.9	160
Dederang 330/220 kV transformer loading	Install a control scheme that automates the enablement of the additional cooling on the DDTS H3 transformer, thereby allowing the 340 MVA short term rating to be used at all times, effectively increasing the transformer rating from 240 MVA to 340 MVA.				Request for proposal underway	100
	Install a fourth 330/220 kV transformer at Dederang (or a newly established station nearby)				Cost to be determined	400

Murray River REZ

The Murray River REZ remains a high risk REZ for proposed connections, with low system strength, no existing spare hosting and a low average marginal loss factor.

Prior to delivery of any committed transmission investment, the hosting capacity of the Murray River REZ is currently at its limit. Generators in this REZ are often materially constrained by thermal and voltage stability constraints during system normal conditions (see Section 2.7), and further connections to this REZ may face challenges commissioning under these conditions¹⁰⁸.

Project Energy Connect, planned for completion by mid-2024, will increase thermal capacity and allow local sources of reactive power from New South Wales and South Australia, and is projected to increase the REZ hosting capacity in the Murray River REZ by up to 380 MW. Additionally, AEMO’s Murraylink very fast runback (VFRB) scheme enhancement, planned for completion in early-2022, will increase REZ hosting capacity in the Murray River REZ by approximately 20 MW.

¹⁰⁸ See State of the System newsletter, AEMO, July 2021, at <https://aemo.com.au/newsroom/news-updates/state-of-the-system-2021-july>.

Proponent-led investments, such as new generation or the projects also proposed to provide services to strengthen the system under the Victorian Government’s RDP, may also be capable of providing additional reactive power support to the REZ. However, this potential capability is subject to any investment commitment, the physical facilities proposed and how those facilities are operated.

Table 20 Murray River REZ health and investment options

V2 – Murray River	Connection risk	Existing (with committed project) spare hosting capacity (MW)	Average 2021-22 MLF	Thermal constraints	Stability constraints	System strength
REZ Health	High	0 (400)	0.9207	Constrained	Constrained	Low
Limitation	Possible network solutions				Indicative estimated cost (\$M)	Indicative hosting capacity increase (MW)
Red Cliffs – Wemen – Kerang – Bendigo 220 kV line (high generation)	Install a new single 220 kV circuit line from Kerang to Red Cliffs via Wemen				308-720	300-800 ^A
Voltage instability / collapse in north-west Victoria (around Wemen Terminal Station)	NMAS contract for the use of spare reactive power capacity or install dynamic voltage regulation such as an SVC				30-60	30-260
Low system strength	Install system strength providing facilities such as a synchronous condenser or energy storage facility behind a grid-forming inverter				Solution size dependent	Solution size dependent

A. Realising the full 800 MW hosting capacity increase relies on implementation of VNI West Kerang to remove of other limitations.

Western Victoria REZ

The Western Victoria REZ remains a high risk REZ for proposed connections, with low system strength and no existing spare hosting capacity.

Prior to delivery of any committed transmission investment, the hosting capacity of the Western Victoria REZ is currently at its limit. Generators in this REZ are often materially constrained by thermal and voltage stability constraints during system normal conditions (see Section 2.7), and further connections to this REZ may face challenges commissioning under these conditions¹⁰⁹.

The Western Victoria Transmission Network Project (WVTNP), expected to be completed by 2025, is estimated to increase the REZ hosting capacity in Western Victoria by approximately 450 MW.

Table 21 Western Victoria REZ health and investment options

V3 – Western Victoria	Connection risk	Existing (with committed project) spare hosting capacity (MW)	Average 2021-22 MLF	Thermal constraints	Stability constraints	System strength
REZ Health	High	0 (70)	0.9732	Constrained	Constraints Emerging	Low

¹⁰⁹ See State of the System newsletter, AEMO, July 2021, at <https://aemo.com.au/newsroom/news-updates/state-of-the-system-2021-july>.

V3 – Western Victoria	Connection risk	Existing (with committed project) spare hosting capacity (MW)	Average 2021-22 MLF	Thermal constraints	Stability constraints	System strength
Limitation	Possible network solutions				Indicative estimated cost (\$M)	Indicative hosting capacity increase (MW)
Red Cliffs – Kiamal – Murra Warra - Horsham-Bulgana 220 kV line loading	Install an automatic generation runback control scheme				Request for proposal underway	270
	Modify the existing Murraylink Very Fast Runback (VFRB) control scheme to operate for Murraylink import from South Australia to Victoria				Request for proposal underway	170
	Line limiting plant upgrades at Ballarat, Ararat, Waubra, Bulgana and Kiamal 220 kV terminal stations				Request for proposal underway	155
	Install a new double circuit Bulgana to Murra Warra 220kV line via a new terminal station at Horsham				366	1,000
Low system strength	Install system strength providing facilities such as a synchronous condenser or energy storage facility behind a grid-forming inverter				Solution size dependent	Solution size dependent

South West REZ

The South West REZ has a medium level of risk for proposed connections, with system strength and hosting capacity limitations emerging compared to a very strong pipeline of connections interest, while the South West 500 kV network has some hosting capacity,

Table 22 South West REZ health and investment options

V4 – South West	Connection risk	Existing (with committed project) spare hosting capacity (MW)	Average 2021-22 MLF	Thermal constraints	Stability constraints	System strength
REZ Health	Medium	750	0.9819	Constraints emerging	Constraints emerging	Low-Average
Limitation	Possible network solutions				Indicative estimated cost (\$M)	Indicative hosting capacity increase (MW)
Ballarat – Berrybank – Terang – Moorabool 220 kV line loading	Install an automatic generation runback control scheme				Request for proposal underway	190
	A new Moorabool – Mortlake/Tarrone – Heywood 500 kV line				1,200	2,700
Inadequate south-west Melbourne 500 kV thermal capacity	Line limiting plant upgrades at 500 kV terminal stations between Moorabool and Heywood and install a wind monitoring dynamic line rating scheme on the 500 kV double circuit line between Moorabool and Heywood				Request for proposal underway	290

V4 – South West	Connection risk	Existing (with committed project) spare hosting capacity (MW)	Average 2021-22 MLF	Thermal constraints	Stability constraints	System strength
Moorabool 500/220 kV transformer loading	Transformer limiting plant upgrades at Moorabool				Request for proposal underway	260
Voltage collapse in South West Victoria	Cut in Haunted Gully – Tarrone 500 kV line at Mortlake to form the Haunted Gully – Mortlake – Tarrone 500 kV line				Cost to be determined	900
Geelong - Keilor 220 kV line loading	Replace the existing Geelong – Keilor No.1 and No.3 220 kV lines with a new double circuit line, each circuit rated at 700 MVA at 35°C				191	1,100
Sydenham – Keilor 500 kV line loading	Line limiting plant upgrades at Sydenham and Keilor terminal stations				Request for proposal underway	1,550
Low system strength	Install system strength providing facilities such as a synchronous condenser or energy storage facility behind a grid-forming inverter				Solution size dependent	Solution size dependent

Gippsland REZ

The Gippsland REZ remains a low risk REZ for proposed connections, with existing spare hosting capacity, high system strength and a reasonably strong average marginal loss factor.

However, the level of system strength, both in the Gippsland REZ and Victoria wide, will continue to be monitored as synchronous generation in the Latrobe Valley retires or is, in the absence of being constrained on for system strength or other operational constraints, displaced by lower-cost inverter-based resources (IBR) connecting in the Gippsland REZ.

Additionally, while there is still existing spare hosting capacity available in this REZ, the 500 kV network in the eastern end of this REZ has already been under stress due to a large amount of existing generation (including import from Basslink) already connected at or east of Loy Yang 500 kV, compounded with the special 500 kV network configuration between Loy Yang and Hazelwood.

AEMO has experienced operational challenges to maintain security and reliability under certain operating conditions, in particular during periods of a prior outage of any of the three existing 500 kV lines between Loy Yang and Hazelwood (see Section 4.6.4) for more information on the operational challenges. Any additional generation connected at, or east of, Loy Yang is expected to increase the operational challenges and may need to be constrained under such conditions. Possible network solutions include the installation of a fourth Hazelwood – Loy Yang 500 kV circuit, which will significantly increase the spare hosting capacity at or east of Loy Yang through network thermal capability improvement and removal of the operational challenges. However, it is worth noting that the fourth Hazelwood – Loy Yang 500 kV circuit alone will not increase the overall hosting capacity of the Gippsland REZ, but rather extend it from Hazelwood to Loy Yang, because the REZ hosting capacity depends mainly on the capacity of the transmission network between Hazelwood and Melbourne.

Table 23 Gippsland REZ health and investment options

V5 – Gippsland	Connection risk	Existing (with committed project) spare hosting capacity (MW)	Average 2021-22 MLF	Thermal constraints	Stability constraints	System strength
REZ Health	Low	2000	0.9774	Capacity available	Capacity available	High
Limitation	Possible network solutions				Indicative estimated cost (\$M)	Indicative hosting capacity increase (MW)
Hazelwood – Loy Yang 500 kV line loading	Construct a new single circuit Hazelwood – Loy Yang 500 kV line				Cost to be determined	3,000 ^A

A. The 3000 MW hosting capacity increase only considers thermal limitations between Hazelwood and Loy Yang and may be limited by other thermal, stability and operations limitations.

Central North REZ

The Central North REZ has a medium level risk for proposed connections, with system strength and hosting capacity limitations emerging compared to a very strong pipeline of connections interest.

Table 24 Central North REZ health and investment options

V6 – Central North	Connection risk	Existing and (committed) spare hosting capacity (MW)	Average 2021-22 MLF	Thermal constraints	Stability constraints	System strength
REZ Health	Medium	690	1.0178	Constraints emerging	Capacity available	Average
Limitation	Possible network solutions				Indicative estimated cost (\$M)	Indicative hosting capacity increase (MW)
Dederang –Glenrowan –Shepparton –Bendigo 220 kV and Dederang – Shepparton 220 kV line loading	Install an automatic generation runback control scheme to enable the use of five-minute line rating				Request for proposal underway	70-180
	Install a wind monitoring scheme				Cost to be determined	100

REZ system strength

AEMO has also assessed potential future REZ system strength requirements driven by optimal generator build patterns (see Section 6.2). However, under the current rules individual connecting parties are required to fund their own system strength remediation activities and demonstrate that their specific connection does not have an adverse impact on the overall system strength performance of the network. Coordinated investment in system strength devices (by proponents or third-party investors) could result in a more efficient outcome

overall, and the AEMC has recently made a new rule on the system strength framework, as outlined in Section 4.5.2.

6.4 Victorian Government initiatives

This section outlines the current investments, beyond the *Transmission Development Plan for Victoria*, that the Victorian Government is currently considering, to facilitate prospective connections, minimise generator curtailment, and advance the renewable energy transition to develop Victoria's REZs.

6.4.1 Victorian Government projects

The Victorian Government announced a \$1.6 billion clean energy package, through the 2020–21 State Budget, to invest in renewables, grid infrastructure, energy efficiency and decarbonisation projects. This included a \$540 million REZ fund to help develop the six Victorian REZs AEMO identified in its ISP.

In February 2021, the Victorian Government published the Victorian RDP Directions Paper¹¹⁰ identifying nine potential Stage 1 projects and 21 potential Stage 2 projects to unlock up to 10 GW of renewable energy capacity.

Stage 1 RDP Projects

In August 2021, the Victorian Government announced six priority projects to progress through Stage 1 procurement, with further assessments required before making decisions on another two of the Stage 1 projects.

The Victorian Minister for Energy, Environment and Climate Change, Lily D'Ambrosio, consequently made a Ministerial Order¹¹¹ under section 16Y of the NEVA, directing AEMO to undertake procurement processes to progress three contestable projects for services to strengthen the system, as well as three sets of non-contestable minor network augmentations. The Ministerial Order directs AEMO to undertake procurement processes, including a call for expressions of interest and tender process for the contestable projects and a request for proposal process for the non-contestable projects. A subsequent Ministerial Order, or Ministerial Orders, will be required prior to any investment commitment to procure any of the proposed Stage 1 specified augmentations or non-network services projects.

Services to strengthen the system

On 18 August 2021, AEMO issued a Call for Expressions of Interest (CEI) for non-network services to strengthen the system. This CEI closed on 14 September 2021 and AEMO is currently assessing submissions before commencing a closed Invitation to Tender (ITT) process with short-listed CEI applicants.

The services being sought are, for or in respect of the following REZs:

- Murray River REZ, to increase the capability of the system to remain stable with connection of up to 300 MW of additional generation capacity.
- Western Victoria REZ, to increase the capability of the system to remain stable with connection of up to 600 MW of additional generation capacity.
- South West REZ, to increase the capability of the system to remain stable with connection of up to 600 MW of additional generation capacity.

Whilst the RDP Directions Paper expressed each of the required services in terms of a synchronous condenser of a specific MVA size and location, AEMO acknowledges that a range of potential technology solutions, measured in a variety of ways, may be capable of providing the required services, and that they may be

¹¹⁰ At https://www.energy.vic.gov.au/_data/assets/pdf_file/0016/512422/DELWP_REZ-Development-Plan-Directions-Paper_Feb23-updated.pdf.

¹¹¹ See <http://www.gazette.vic.gov.au/gazette/Gazettes2021/GG2021S417.pdf>.

provided by one or more facilities individually or combined. As such, the contestable process that AEMO is currently undertaking on the Victorian Government’s behalf is technology-neutral.

Noting that low system strength has become a barrier to connection, the services being sought are those that can ensure stable operation of the system with connection of additional generator capacity. It is however acknowledged that, without network capacity augmentations targeting any thermal, voltage and/or transient stability limit improvements, generator curtailment due to a lack of spare hosting capacity in some REZs may still be required at certain times.

Minor network augmentations

AEMO is undertaking a non-contestable request for proposal process with relevant incumbent network service providers for three sets of minor network augmentations. These sets of minor network augmentations are intended to provide incremental spare hosting capacity in the identified REZs by 2025, with larger hosting capacity increases, planned for post-2025, to be considered under Stage 2 of the RDP.

The three sets of minor network augmentations are grouped by REZ and span the South West REZ, the Murray River REZ and the Central North REZ, as presented in Table 25, Table 26, and Table 27.

Table 25 South West REZ – RDP Stage 1 Specified Augmentations

Limitation	Proposed RDP Stage 1 network solutions	Indicative maximum hosting capacity increase (MW) ^A
Ballarat – Berrybank – Terang – Moorabool 220 kV line loading	Install an automatic generation runback control scheme	190
Inadequate south-west Melbourne 500 kV thermal capacity	Line limiting plant upgrades at 500 kV terminal stations between Moorabool and Heywood and install a wind monitoring dynamic line rating scheme on the 500 kV double circuit line between Moorabool and Heywood	290
Sydenham – Keilor 500 kV line loading	Line limiting plant upgrades at Sydenham and Keilor terminal stations	1,550
Moorabool 500/220 kV transformer loading	Relevant limiting plant upgrades at Moorabool	260

A. While the indicative hosting capacity presents the additional generation that could connect in the REZ and operate under optimal network conditions, on an annual energy output basis the average hosting capacity increase across the four South West REZ projects is 81 MW.

Table 26 Murray River REZ – RDP Stage 1 Specified Augmentations

Limitation	Proposed RDP Stage 1 network solutions	Indicative maximum hosting capacity increase (MW) ^A
Red Cliffs – Kiamal – Murra Warra - Horsham- Bulgana 220 kV line loading	Install an automatic generation runback control scheme	270
	Modify the existing MurrayLink Very Fast Runback (VFRB) control scheme to operate for MurrayLink import from South Australia to Victoria	170
	Line limiting plant upgrades at Ballarat, Ararat, Waubra, Bulgana and Kiamal 220 kV terminal stations	155

A. While the indicative hosting capacity presents the additional generation that could connect in the REZ and operate under optimal network conditions, on an annual energy output basis the average hosting capacity increase across the three Murray River REZ projects is 112 MW.

Table 27 Central North REZ – RDP Stage 1 Specified Augmentations

Limitation	Proposed RDP Stage 1 network solutions	Indicative maximum hosting capacity increase (MW) ^A
Dederang –Glenrowan – Shepparton –Bendigo 220 kV line loading	Install an automatic generation runback control scheme to enable the use of five-minute line ratings	70-180
Dederang 330/220 kV transformer loading	Install a control scheme that automates the enablement of the additional cooling on the DDTS H3 transformer, thereby allowing the 340 MVA short term rating to be used at all times, effectively increasing the transformer rating from 240 MVA to 340 MVA.	100

A. While the indicative hosting capacity presents the additional generation that could connect in the REZ and operate under optimal network conditions, on an annual energy output basis the average hosting capacity increase across the two Central North REZ projects is 12 MW.

RDP projects undergoing further consideration

In addition to the three sets of RDP Stage 1 minor augmentation projects and three services to strengthen the system that the Victorian Government has directed AEMO to progress through procurement activities, the Victorian Government is considering next steps on further Stage 1 projects¹¹².

AEMO will continue to work collaboratively with the Victorian Government in identifying potential medium-term investments that may be progressed through Stage 2 of the RDP.

6.4.2 VRET2 Auction

On 31 August 2021, the Victorian Government opened VRET2¹¹³, which aims to bring online at least 600 MW of new renewable energy capacity in Victoria by 30 December 2024.

The Victorian Government intends to support new generation by entering into Support Agreements with successful proponents of the VRET2 Auction. The Support Agreement is expected to include a 10-year Contract-for-Difference (CfD) payment mechanism designed to encourage new renewable generation connections by reducing wholesale electricity price risk for proponents, while also reducing Government exposure to electricity price risk.

The Support Agreement will also see the Victorian Government receive all Large-scale Generation Certificates (LGCs) generated by VRET2 projects, which will in turn be voluntarily surrendered to the Clean Energy Regulator (CER) so the projects contribute to offsetting greenhouse gas emissions.

The VRET2 evaluation criteria will have strengthened network requirements to evaluate the project’s impact on the existing electrical network infrastructure and incentivise grid connections in healthier areas of the network, aligned with stronger locational investment signals (see Section 6.3.3).

The Victorian Government expects to announce the successful VRET2 projects mid-2022.

6.5 Adapting to changing connection needs

The connections process spans the entirety of a project, from pre-feasibility, when proponents begin discussions with AEMO, through to completion, when the plant is registered and AEMO reviews and approves commissioning plans, coordinates testing with operations, and reviews plant performance at successive hold points.

Management of connections requires holistic assessment of the entire landscape to ensure an operational future network. AEMO continues to evolve its connections management with a strong emphasis on

¹¹² See <https://www.premier.vic.gov.au/new-projects-accelerate-victorias-renewable-energy-zones>

¹¹³ See <https://www.energy.vic.gov.au/renewable-energy/vret2>.

transparent processes, common methodologies, improved project tracking, and novel and enhanced modelling capabilities, such as the Connections Simulation Tool, to manage the increasing volume and complexity of new connections.

6.5.1 Connections uplift program

AEMO is uplifting the Victorian connections process to give stakeholders increased visibility of the connections process, enabling greater information sharing and transparency. Proponents will be able to proactively identify issues at proposed connection locations and explore solutions early in the connections process.

The uplift program is progressing across the following workstreams:

- Resourcing and skills adequacy – AEMO is expanding its resource capabilities so appropriately skilled people are available to help proponents work through the connections process. Where required, AEMO is also leveraging consultant expertise to provide specialist technical advice and support on complex generator performance issues.
- Technical advice and expertise – AEMO has developed pre-application work packages to allow generation proponents to begin working through project timing, infrastructure specifications, identifying and resolving key project issues, and generator model tuning before an application is submitted. Generator portfolio modelling, to identify forward-looking challenges for new connections, will also be undertaken. Key focus areas will be system strength, network congestion and constraints, operational issues and control schemes, and impacts of transmission outage plans on generator commissioning. AEMO is also reviewing its infrastructure requirements for new connections.
- Common understanding of connections processes – AEMO will work with industry to clarify and standardise understanding of connections requirements, to improve consistency of the connections process across the NEM. Last year, AEMO delivered education forums to its NEM and Victorian stakeholders to map the connections process, and identify and work through common practical issues encountered in the connection process.
- Account management and communication – AEMO will continue to assign dedicated project managers to projects, supported by a new stakeholder management system and the resourcing workstream described above. Enhanced project tracking now provides greater visibility to proponents on their project's connection process and status. AEMO is providing regular updates on key challenges and milestones via the State of the System newsletter, and is planning to develop information on REZs and popular connection locations.
- Connections support and system expansion – AEMO is supporting delivery of the 50% VRET by 2030 through providing expert support for the Victorian Government's VRET2 process. It is also managing the procurement of services for the RDP.
- Regulatory reforms – AEMO is working jointly with the Clean Energy Council and other interested stakeholders on the Connections Reform Initiative. The team has identified a number of priority workstreams and is developing a roadmap to deliver them. Key areas of focus include potential changes to access standards and AEMO guidelines, provision of greater and more consistent information for connections assessments across all parties, the pre-qualification of generator models, providing investment certainty for generator registration, and batching of connection assessments.
- Enhanced system modelling – AEMO is developing the Connections Simulation Tool, intended to provide a platform for generation proponents to test and assess the impacts of their projects early, as described in Section 6.5.2.

6.5.2 Connections Simulation Tool

Detailed modelling has become essential for technical assessments in weak areas of the grid. In recent years, the nature and complexity of potential interactions in some parts of the network have required that connections studies be done incrementally to ensure that performance standards are met without causing

adverse security or power quality issues. This increased modelling complexity has meant that securing a new grid connection in some areas of the network has become a barrier to the energy transition.

With electromagnetic transient (EMT) modelling now an essential part of most connection studies, and EMT-type assessments becoming increasingly necessary for both mid- and long-term planning, wider access to network models has become increasingly important.

To enable prospective generators to assess the network impact and stability of a prospective generator, AEMO, in an initiative supported by the Australian Renewable Energy Agency (ARENA), has begun developing a Connections Simulation Tool¹¹⁴. This world-first Connections Simulation Tool, an extension to AEMO's Real-Time Simulator¹¹⁵, will provide applicants portal access to protected wide-area models equivalent to those used within AEMO, providing developers, Original Equipment Manufacturers (OEMs), NSPs, and consultants the opportunity to streamline connection application approvals.

The Connections Simulation Tool will initially utilise PSCAD™ and later be expanded to add the HYPERSIM™ platform as an extra means of performing simulations. The PSCAD™ version release is expected in Q4 2021, with the HYPERSIM™ platform addition targeted for the first half of 2022.

6.6 Adapting to new technologies

AEMO is working to better utilise emerging technologies and include novel non-network solutions to solve existing and emerging network limitations whenever possible and economic. Many new technologies can be deployed more rapidly and on a more modular basis than traditional network solutions, making them a flexible solution to meet the rapidly changing system needs. However, due to the immaturity and lack of demonstrated grid-scale application of some new technologies, network planners and operators must take a prudent approach when integrating them into already stretched transmission systems.

To support the energy transition and integration of new technology, AEMO continues to partner and support a range of research, development, and technology pilot programs across Victoria, including partnering with Monash University to investigate stability issues and enhancing measures for weak power grids¹¹⁶.

Section 6.5 of AEMO's 2020 VAPR¹¹⁷ explored, in detail, applications of emerging technology to the network planning process. The following section draws on AEMO's recently published *Application of Advanced Grid-scale Inverters in the NEM* white paper¹¹⁸ to further contextualise how advanced inverters might provide novel solutions to network limitations.

6.6.1 Advanced grid-scale inverters

As more inverter-based generation sources are installed on the Victorian network, power electronic inverters will play a larger role in the operation of the power system. Most inverter-based connections are currently considered grid-following; this means they require the grid voltage and frequency as a reference point to stay in synchronism with the grid. An important pre-requisite is a stable voltage waveform that the grid-following inverter can track. As such, grid-following inverters are less able to operate in parts of the network exhibiting extremely low system strength and where synchronous sources are electrically distant.

Grid-forming inverters is a general term for devices that can use an internal voltage and frequency reference. These devices are less dependent on (or independent of) grid references, and have the potential to operate in weaker parts of the network. Grid-forming inverters can strengthen local voltage waveforms, and help support nearby grid-following inverters.

¹¹⁴ See <https://aemo.com.au/initiatives/trials-and-initiatives/connections-simulation-tool-project>.

¹¹⁵ See <https://aemo.com.au/en/initiatives/trials-and-initiatives/real-time-simulator>.

¹¹⁶ See <https://arena.gov.au/projects/stability-enhancing-measures-for-weak-grids/>.

¹¹⁷ See https://aemo.com.au/-/media/files/electricity/nem/planning_and_forecasting/vapr/2020/2020-vapr.pdf?la=en.

¹¹⁸ See <https://aemo.com.au/-/media/files/initiatives/engineering-framework/2021/application-of-advanced-grid-scale-inverters-in-the-nem.pdf?la=en&hash=B4E20D68B23F66090ADA5FD47A50D904>.

However, grid-forming inverters also require extra layers of control systems to maintain synchronism, and to date they have predominately been deployed in smaller, islanded power system applications. The Dalrymple Energy Storage for Commercial Renewable Integration (ESCRI) BESS in South Australia is currently the world's largest grid-forming BESS, at 30 MVA and 8 MWh. In a larger system, multiple grid-forming devices, that each follow their own reference point, may lead to an uncoordinated or distorted voltage waveform. To resolve this, coordination across the system needs to be considered during planning to avoid unexpected system incidents, and fewer but larger grid-forming BESS' may be preferable.

AEMO's *Application of Advanced Grid-scale Inverters in the NEM* white paper identified four potential applications for advanced grid-scale inverters, outlined below in order of increasing capability and expected system need and technology maturity over time:

- **Connecting IBR in weak grid areas** – capability to maintain stable operation in weak grid areas to meet IBR performance obligations, and potentially provide system strength to support the connection of other nearby IBR plant. This application provides localised capability to stabilise nearby IBR generation, but does not necessarily support the broader power system.
- **Supporting system security** – capabilities to maintain system security that are predominately provided by synchronous generators today, such as inertia and system strength, to support the broader power system as it transitions to operating with fewer synchronous generators online.
- **Island operation** – capabilities to maintain stability and supply balancing at a high enough level to support areas of the grid that become separated from the main synchronous system when operating under high penetrations of IBR.
- **System restart** – capability to energise the local network during the challenging conditions of a black system, or to assist with the restoration process.

Advanced inverters have shown their capability to provide a range of valuable capabilities in a bulk power system, but the maturity and demonstrated scale of these capabilities is limited. Simulation indicates potential for grid-forming BESS to provide system strength and help stabilise areas of network, however this is yet to be demonstrated at scale. Demonstration of such capability at grid-scale requires funding and support to account for developer risk and increased costs associated with higher capacity and advanced inverter installations. These costs include upfront infrastructure, compliance, ongoing operation, and difficulty securing investment in a design that is not yet well understood by industry.

A1. Distribution network service provider planning

This appendix lists the preferred connection modifications from the *2020 Transmission Connection Planning Report*¹¹⁹ and the potential DSN impacts and considerations.

Location/terminal station	Preferred connection modification	DSN impacts and considerations
Alfona No. 3 and 4 66 kV	Install additional transformation capacity and reconfigure 66kV exits at ATS by the end of 2029.	Increased demand requiring this transformer will be included in Greater Melbourne and Geelong planning.
Cranbourne 66 kV	Install a fourth Cranbourne 225 MVA 220/66kV transformer by end of 2026, unless an alternative non-network development arises.	Increased demand requiring this transformer will be included in Greater Melbourne and Geelong planning.
Deer Park 66 kV	Procure a spare 225 MVA transformer by end of 2026r	Increased demand requiring this transformer will be included in Greater Melbourne and Geelong planning.
Wemen 66 kV	Additional embedded generation may justify additional transformation capacity	Monitoring embedded generation output levels will continue.

¹¹⁹ Jemena, CitiPower, Powercor, AusNet Services and United Energy, at <https://www.unitedenergy.com.au/wp-content/uploads/2020/12/Transmission-Connection-Planning-Report-2020.pdf>.

A2. DSN limitation detail

These details for transmission network limitations are grouped geographically.

The changes in the list of limitations are:

- New:
 - Additional trigger of YPS for the limitation of insufficient reactive support in Melbourne Metropolitan and south-west transmission corridor.
 - Overload of Hazelwood – Yallourn and Hazelwood – Rowville 220 kV lines due to YPS retirement. This is considered a developing limitation, as outlined in Section 4.3.
 - Overload of Hazelwood – Loy Yang 500 kV line due to new generation connection has been added to the list of monitored limitations.
 - Insufficient demand to maintain minimum synchronous requirement has been added to the list of monitored limitations.
 - Limited outage window of the Hazelwood – Loy Yang 500k V line due to YPS retirement has been added to the list of developing limitations.
- Change in category:
 - Insufficient reactive support in Melbourne Metropolitan region. This is now considered a priority limitation, as outlined in Section 4.3.
 - Overload of Moorabool – Geelong – Keilor 220 kV line. This is now considered a developing limitation, as outlined in Section 4.3.
 - Overload of Cranbourne 500/220 kV transformer. This is now considered a developing limitation, as outlined in Section 4.3.
 - Overload of Rowville 500/220 kV transformer. This is now considered a developing limitation, as outlined in Section 4.3.
- Removed:
 - None.

The options presented in the sub-sections below should be treated as indicative only, and a RIT-T will be required to determine the full list of network and non-network options as well as the preferred option. The preferred option may include one or a combination of the options presented in the sub-sections below.

In this appendix, triggers are defined as the operating conditions under which a limitation may result in supply disruptions or constrain generation at increased frequency. A trigger being met will not necessarily result in any augmentations as that would be subjected to a RIT-T or appropriate consideration.

A2.1 Central North REZ

Limitations in the Central North REZ

Limitation	Limitation type	Possible network solution	Trigger	2020 ISP / 2020 NSCAS	Contestable project status
Dederang – Glenrowan – Shepparton – Bendigo 220 kV and Dederang – Shepparton 220 kV line loading	Developing	<ul style="list-style-type: none"> Install an automatic load shedding and generation runback control scheme to enable the use of five minute line rating. Install a wind monitoring scheme. Install a modular flow controller on the Bendigo – Fosterville – Shepparton 220 kV line at an estimated cost of \$60M. Replace existing Dederang – Shepparton and Shepparton – Bendigo 220 kV line with new double circuit lines at estimated cost of \$620M. 	<p>Increased demand in regional Victoria and/or increased import from New South Wales.</p> <p>Large-scale new generation connected to Western Victoria area, and congestion within Western Victoria relieved to allow the new generation to be sent out of Western Victoria.</p>	Identified limitation as part of Central North Victoria REZ	The new transformer or new transmission lines are likely to be contestable projects.

A2.2 Eastern Corridor

Limitations in the Eastern Corridor

Limitation	Limitation type	Possible network solution	Trigger	2020 ISP / 2020 NSCAS	Contestable project status
Hazelwood – Yallourn 220 kV line loading	Developing	<ul style="list-style-type: none"> Construct a new single circuit Hazelwood – Yallourn 220 kV line at an estimated cost of \$31.5M Construct a new double circuit Hazelwood – Yallourn 220 kV line and string only one circuit at an estimated cost of \$34.3M Construct a new double circuit Hazelwood – Yallourn 220 kV line and string both circuits at an estimated cost of \$37.1M Rebuild existing double circuit Hazelwood – Yallourn 220 kV line to a higher rating at an estimated cost of \$33.4M 	Post YPS retirement if the Latrobe Valley is operated in a parallel configuration and additional generation	Not identified	<p>The new line is likely to be a contestable project.</p> <p>The line upgrade is unlikely to be a contestable project.</p>
Hazelwood – Rowville 220 kV line loading	Monitored	<ul style="list-style-type: none"> Construct a new single circuit Hazelwood – Rowville 220 kV line 	Post YPS retirement if the Latrobe Valley is operated in a parallel configuration and additional	Not identified	The new line is likely to be a contestable project.

Limitation	Limitation type	Possible network solution	Trigger	2020 ISP / 2020 NSCAS	Contestable project status
		<ul style="list-style-type: none"> Construct a new double circuit Hazelwood – Rowville 220 kV line and string only one circuit Construct a new double circuit Hazelwood – Rowville 220 kV line and string both circuits 	generation is commissioned on the 220 kV network at HWPS, at a site east of HWPS or on the 500 kV network east of CBTS.		
Rowville – Yallourn 220 kV line loading	Monitored	<ul style="list-style-type: none"> Construct a new single circuit Rowville – Yallourn 220 kV line Construct a new double circuit Rowville – Yallourn 220 kV line and string only one circuit Construct a new double circuit Rowville – Yallourn 220 kV line and string both circuits 	Post YPS retirement if the Latrobe Valley is operated in a parallel configuration and additional generation is commissioned on the 220 kV network at HWPS, at a site east of HWPS or on the 500 kV network east of CBTS.	Not identified	The new line is likely to be a contestable project.
Hazelwood – Loy Yang 500 kV line loading	Monitored	<ul style="list-style-type: none"> Construct a new single circuit Hazelwood – Loy Yang 500 kV line Construct a new double circuit Hazelwood – Loy Yang 500 kV and string only one circuit Construct a new double circuit Hazelwood – Loy Yang 500 kV and string both 	Commissioning of additional generation connected at Loy Yang Power Station.	Identified in 2020 ISP	The new line is likely to be competitively sourced
Rowville – Yallourn 220 kV line loading	Monitored	<ul style="list-style-type: none"> Upgrade the 220 kV Hazelwood – Rowville or Yallourn – Rowville lines. 	During period of extremely high temperature and high output from YPS.	Not identified as a material limitation in the scenarios modelled.	The line upgrade is unlikely to be a contestable project.
System strength shortfall at Hazelwood	Developing	<ul style="list-style-type: none"> Installation of a synchronous condenser at an estimated cost of \$125.5M each. 	Retirement of synchronous generators	Identified in 2020 ISP	This is likely to be a contestable project
Hazelwood – Loy Yang 500 kV line outage	Developing	<ul style="list-style-type: none"> Construct a new single circuit Hazelwood – Loy Yang 500 kV line Construct a new double circuit Hazelwood – Loy Yang 500 kV and string only one circuit Construct a new double circuit Hazelwood – Loy Yang 500 kV and string both 	Lack of outage window period due to constricted maximum and minimum demand threshold post YPS retirement.	Not identified	The new line is likely to be competitively sourced.

A2.3 Northern Corridor

Limitations in the Northern Corridor

Limitation	Limitation type	Possible network solution	Trigger	2020 ISP / 2020 NSCAS	Contestable project status
Dederang – Mount Beauty 220 kV line loading	Monitored	<ul style="list-style-type: none"> Install a wind monitoring scheme. Up-rate the conductor temperature of both 220 kV circuits between Dederang and Mount Beauty to 82°C, at estimated cost of \$13.3M. 	Increased demand in Metropolitan Melbourne or increased export to New South Wales with high hydro generation in the area.	Not identified as a material limitation in the scenarios modelled.	These are unlikely to be contestable projects.
Mount Beauty – Eildon – Thomastown 220 kV line loading	Monitored	<ul style="list-style-type: none"> Install wind monitoring scheme Up-rate Mount Beauty - Eildon – Thomastown 220 kV line, including terminations to 75 °C operation, at estimated cost of \$114.9M. 	Increased New South Wales import and export.	Not identified as a material limitation in the scenarios modelled.	This is unlikely to be a contestable project.
Dederang 330/220 kV transformer loading	Monitored	<ul style="list-style-type: none"> Install a fourth 330/220 kV transformer at Dederang (or a newly established station nearby). 	At times of over 2,500 MW of imports from New South Wales and Murray generation (with the DBUSS transformer control scheme being active).	Not identified as a material limitation in the scenarios modelled.	The new transformer is likely to be a contestable project.
Voltage stability at North Victoria/ South New South Wales (import)	Monitored	<ul style="list-style-type: none"> Procure network support services, including the provision of additional reactive support (generating). Install additional capacitor banks and/or controlled series compensation at Dederang and Wodonga terminal stations. 	Increased import from New South Wales to Victoria (high demand in Victoria).	Not identified as a material limitation in the scenarios modelled.	These are both likely to be contestable projects.
Voltage stability at North Vic/South New South Wales (export)	Monitored	<ul style="list-style-type: none"> Procure network support services Install an SVC or a STATCOM at an estimated cost of \$30.0M. 	Increased export to New South Wales from Victoria under minimum demand in Victoria.	Constraint identified during high export to New South Wales.	These are both likely to be contestable projects.
Murray – Dederang 330 kV line loading	Monitored	<ul style="list-style-type: none"> Install third 1,060 MVA 330 kV line between Murray and Dederang (or a newly established station nearby). Install second 330 kV line from Dederang (or a newly established station nearby) to Jindera. 	Increased import from New South Wales to Victoria or Murray generation.	Not identified as a material limitation in the scenarios modelled.	These are both likely to be contestable projects.

A2.4 Murray River REZ

Limitations in Murray River REZ

Limitation	Limitation type	Possible network solution	Trigger	2020 ISP/ 2020 NSCAS	Contestable project status
Voltage oscillation in western and north-west Victoria (under prior outage)	Developing	<ul style="list-style-type: none"> NMAS contracts to provide system strength. Install an automatic generation runback control scheme. 	<p>Increased probability of prior outages of local 220 kV transmission lines.</p> <p>Reduced system strength in the region.</p>	Constraint identified during high solar generation and prior outage.	These are likely to be contestable projects.
Red Cliffs – Wemen – Kerang – Bendigo 220 kV line (high generation)	Priority	<ul style="list-style-type: none"> Replace the existing Bendigo – Kerang – Wemen – Red Cliffs 220 kV line with a new double circuit 220 kV circuit line and associated new terminal stations at an estimated cost of \$910 million. 	Increased generation in Regional Victoria.	Identified as limitation as part of Murray River REZ.	These are likely to be contestable projects.
Voltage instability/collapse in North West Victoria (around Wemen Terminal Station)	Priority	<ul style="list-style-type: none"> NMAS contract for the use of spare reactive power capacity. Install dynamic voltage regulation such as SVC at an estimated cost of \$30.0M 	Low local demand and high solar generation.	This was not identified as a limitation as it is a localised issue.	These are both likely to be contestable projects
Red Cliffs – Wemen – Kerang – Bendigo 220 kV line (high demand)	Monitored	<ul style="list-style-type: none"> Install an automatic load shedding control scheme to enable the use of five minute line rating. Replace the existing Bendigo – Kerang – Wemen – Red Cliffs 220 kV line with a new double circuit 220 kV circuit line and associated new terminal stations at an estimated cost of \$910 million. 	Increased demand in Regional Victoria.	Not identified as limitation as it is a localised issue.	These are likely to be contestable projects.

A2.5 South West Victoria REZ

Limitations in the South West Victoria REZ

Limitation	Limitation type	Possible network solution	Trigger	2020 ISP/2020 NSCAS	Contestable project status
Ballarat – Berrybank – Terang – Moorabool 220 kV line	Priority	<ul style="list-style-type: none"> • Install an automatic generation runback control scheme. • Replace the existing Ballarat – Berrybank – Terang – Moorabool 220 kV line with a new double circuit 220 kV circuit line at cost of \$628M. 	Increased generation in regional Victoria.	Identified as limitation as part of South West Victoria REZ.	These are likely to be contestable projects.
Moorabool – Heywood – Portland 500 kV line voltage unbalance	Monitored	<ul style="list-style-type: none"> • A switched capacitor with individual phase switching at Heywood or near Alcoa Portland with an estimated cost of \$15.3M. • Install phase switched power flow controllers at Heywood or near Alcoa Portland. • An SVC or a STATCOM at an estimated cost of \$30.0M. • Additional transposition towers along the Moorabool – Heywood – Alcoa Portland 500 kV line at an estimated cost of \$40.2M. 	New generation connections along the Moorabool – Heywood – Alcoa Portland 500 kV line potentially introduce voltage unbalance along the line. The impact of voltage unbalance levels increases in proportion to power flow, new generation connection points, and output generated.	Limitation not found as part of 2020 ISP/2019 NSCAS as it is related to voltage quality.	<p>Switched capacitor and static VAR options are likely to be contestable projects.</p> <p>Line transposition is unlikely to be a contestable project.</p>
Inadequate south-west Melbourne 500 kV thermal capacity	Monitored	<ul style="list-style-type: none"> • A new Moorabool – Mortlake/Tarrone – Heywood 500 kV line with an estimated cost of \$1,200M. • Line limiting plant upgrades. • Install wind monitoring dynamic line rating scheme. 	Significant wind generation and/or gas-powered generation (GPG) (in addition to the existing generation from Mortlake) is connected to the transmission network in the South-West Corridor.	Identified as a limitation in 2020 ISP South West Victoria REZ Scorecard.	The new line is likely to be a contestable project.
Moorabool 500/220 kV transformer loading	Developing	<ul style="list-style-type: none"> • Transformer limiting plant upgrade. • Install an automatic generation runback control scheme. • Install third Moorabool 500/220 kV transformer costing approximately \$102M. 	Large-scale new generation connected to western Victoria area, and congestion in western Victoria relieved to allow the new generation to be sent out of western Victoria.	Not identified as a material limitation in the scenarios modelled.	The new transformer is likely to be a contestable project.
High ROCOF in south-west Victoria	Developing	<ul style="list-style-type: none"> • Install a post-contingent generation tripping control scheme to control ROCOF during a period when one of the 500 kV lines west of Moorabool is out of service. 	Increased probability of prior outages of 500 kV transmission line west of Moorabool.	Not identified as it is a localised issue.	The control scheme implementation is likely to be a

Limitation	Limitation type	Possible network solution	Trigger	2020 ISP/2020 NSCAS	Contestable project status
			Increased generation connected to the 500 kV lines west of Moorabool.		contestable project.
Voltage collapse in South West Victoria	Developing	<ul style="list-style-type: none"> Cut in Haunted Gully – Tarrone 500 kV line at Mortlake to form Haunted Gully – Mortlake – Tarrone 500 kV line. 	Increased generation on the MLTS – HYTS lines and high import from South Australia.	Not identified.	To be confirmed

A2.6 Greater Melbourne and Geelong

Limitations in Greater Melbourne and Geelong

Limitation	Limitation type	Possible network solution	Trigger	2020 ISP/2020 NSCAS	Contestable project status
Ringwood – Thomastown and Templestowe – Thomastown 220 kV line loading	Monitored	<ul style="list-style-type: none"> Cut in Rowville – Ringwood – Thomastown 220 kV at Templestowe and Rowville – Templestowe – Thomastown 220 kV at Ringwood to form the Rowville – Ringwood – Templestowe – Thomastown No. 1 and No. 2 circuits at an estimated cost of \$15.1M plus any fault level mitigation work. New (third) 500/220 kV transformer at Rowville, with an estimated cost of \$72.5M, plus any fault level mitigation works. 	Increased demand in Eastern Metropolitan Melbourne and/or Latrobe Valley operated in radial configuration after YPS retirement	Not identified as it is a localised issue.	The line cut-in is unlikely to be a contestable project.
Rowville – Malvern 220 kV line loading*	Monitored	<ul style="list-style-type: none"> Cut-in Rowville – Richmond 220 kV No. 1 and No. 4 circuits at Malvern Terminal Station to form the Rowville – Malvern – Richmond No. 3 and No. 4 circuits at estimated cost of \$11.8M. 	Increased demand or additional loads connected to Malvern Terminal Station.	Not identified as it is a localised issue.	The line cut-in is unlikely to be a contestable project.
Rowville – Springvale – Heatherton 220 kV line loading	Monitored	<ul style="list-style-type: none"> Connect a third Rowville – Springvale circuit (underground cable) with estimated cost of \$59.3M. Connect a Cranbourne – Heatherton 220 kV double circuit overhead line with estimated cost of \$38.0M. 	Increased demand or additional loads connected to Springvale and Heatherton Terminal Station.	Not identified as it is a localised issue.	The third circuit is likely to be a contestable project.
Rowville A1 500/220 kV transformer loading	Developing	<ul style="list-style-type: none"> Install a second 500/220 kV 1,000 MVA transformer at Cranbourne with estimated cost of \$72.5M. 	Increased demand in Eastern Metropolitan Melbourne and/or Latrobe Valley operated in a radial configuration after YPS retirement	Not identified as a material limitation in the scenarios modelled.	The new transformer is likely to be a contestable project.

Limitation	Limitation type	Possible network solution	Trigger	2020 ISP/2020 NSCAS	Contestable project status
South Morang H1 330/220 kV transformer loading	Monitored	<ul style="list-style-type: none"> Replace the existing transformer with a higher rated unit in conjunction with AusNet Services asset replacement program. 	Increased demand in Metropolitan Melbourne and/or increased import from New South Wales and/or Latrobe Valley operated in a radial configuration after YPS retirement.	Not identified as a material limitation in the scenarios modelled.	This is unlikely to be a contestable project.
Cranbourne A1 500/220 kV transformer loading	Developing	<ul style="list-style-type: none"> Install a new 500/220 kV transformer at Cranbourne Terminal Station with an estimated cost of \$72.5M (excluding easement cost). 	Increased demand around the Eastern Melbourne Metropolitan area and/or Latrobe Valley operated in a radial configuration after YPS retirement.	Not identified as a material limitation in the scenarios modelled.	The new transformer is likely to be a contestable project.
South Morang – Thomastown No. 1 and No. 2 220 kV line loading	Monitored	<ul style="list-style-type: none"> Increase the transfer capability by installing wind monitoring facilities on the South Morang to Thomastown line. Install an automatic load shedding control scheme to enable the use of five-minute line rating. Install a third 500/220 kV transformer at Rowville, with an estimated cost of \$72.5M, plus any fault level mitigation works. 	Increased demand around the Melbourne Metropolitan area and/or increased export to New South Wales and/or Latrobe Valley operated in a radial configuration after YPS retirement.	Not identified as it is a localised issue.	The new transformer is likely to be a contestable project.
Moorabool – Geelong - Keilor 220 kV line loading	Developing	<ul style="list-style-type: none"> Connect a new double circuit Moorabool – Geelong 220kV line with a rating of approximately 800 MVA at 35°C, with an estimated cost of \$42.7M. Replace the existing Geelong – Keilor 1 and 3 220 kV lines with a new double circuit line, each circuit rated at 800 MVA at 35°C, with an estimated cost of \$190.5M. 	Large-scale new generation connected to western Victoria area, and congestion within western Victoria relieved to allow the new generation to be sent out of western Victoria.	Not identified as a material limitation in the scenarios modelled.	This is likely to be a contestable project.
Keilor – Deer Park – Geelong 220 kV line loading	Monitored	<ul style="list-style-type: none"> Installing a load shedding control scheme Replace the existing Geelong – Keilor No. 1 and No. 3 220 kV lines with a new double circuit line rated at 800 MVA at 35°C, with an estimated cost of \$190.5M. Parallel the existing three Geelong – Deer Park – Keilor 220 kV circuits to form a Geelong – Deer Park and Deer Park – Keilor circuit, each rated 810 MVA at 35° C, at an estimated cost of \$14.1M. 	Increased demand at Deer Park.	Not identified as a material limitation in the scenarios modelled.	These are unlikely to be contestable projects.

Limitation	Limitation type	Possible network solution	Trigger	2020 ISP/2020 NSCAS	Contestable project status
Keilor – Thomastown No. 1 220 kV line	Monitored	<ul style="list-style-type: none"> • Increase the transfer capability by installing wind monitoring facilities on the Keilor to Thomastown line. • Install an automatic load shedding control scheme to enable the use of five-minute line rating • Install a third 500/220 kV transformer at Rowville, with an estimated cost of \$72.5M, plus any fault level mitigation works. 	Latrobe Valley operated in a radial configuration after YPS retirement	Not identified as it is a localised issue.	The new transformer is likely to be a contestable project.
Insufficient reactive support at Deer Park Terminal Station	Monitored	<ul style="list-style-type: none"> • Install capacitors • Install an SVC or STATCOM at an estimated cost of \$30M • Utilise reactive power support from any future battery energy systems 	Increased load at Deer Park terminal station.	Not identified as it is a localised issue.	These are likely to be contestable projects.
Sydenham – Keilor 500 kV line	Monitored	<ul style="list-style-type: none"> • Line limiting plant upgrades at Sydenham and Keilor terminal stations • Install a new single circuit Sydenham – Keilor 500 kV line with a rating of approximately 2,900 MVA at 35°C, with an estimated cost of \$39.1M. • Uprate line rating of the existing 500 kV SYTS–KTS. 	Increased generation in west and south-west Victoria supplying Keilor Terminal Station.	Not identified as a material limitation in the scenarios modelled.	The new line is likely to be a contestable project.
Melbourne Metropolitan Area voltage stability	Monitored	<ul style="list-style-type: none"> • Install additional capacitors at strategic locations. • An SVC or a STATCOM at an estimated cost of \$30.0M. 	Increased maximum demand in the Melbourne Metropolitan area.	Not identified as a material limitation in the scenarios modelled.	These are likely to be contestable projects.
Insufficient reactive support in Melbourne Metropolitan and south-west transmission corridor	Priority	<ul style="list-style-type: none"> • Additional reactors at an estimated cost of \$9.5M each. • Installation of a synchronous condensers at an estimated cost of \$125.5M each. • An SVC or a STATCOM at an estimated cost of \$30M. 	Decreased minimum demand in Melbourne metropolitan area.	Identified in 2019 NSCAS.	These are likely to be contestable projects.
System strength shortfall at Thomastown	Developing	<ul style="list-style-type: none"> • Installation of a synchronous condenser at an estimated cost of \$125.5M each 	Retirement of synchronous generators.	Identified in 2020 ISP.	This is likely to be a contestable project.

* This monitored limitation assumes five-minute ratings are already applied. An automatic load shedding control scheme to enable five-minute line ratings is currently available to manage this limitation.

A2.7 Western Victoria REZ

Limitations in Western Victoria REZ

Limitation	Limitation type	Possible network solution	Trigger	2020 ISP/2020 NSCAS	Contestable project status
Red Cliffs – Kiamal – Murra Warra - Horsham- Bulgana 220 kV line	Priority	<ul style="list-style-type: none"> Install an automatic generation runback control scheme. Install a new double circuit Bulgana to Murra Warra 220kV line via a new terminal station at Horsham at an estimated cost of \$366M. 	Increased generation in Western Victoria and Murray River REZ.	2020 ISP/NSCAS did not identify this limitation.	These are unlikely to be contestable projects.
Inadequate reactive power support in Regional Victoria	Monitored	<ul style="list-style-type: none"> Staged installation of additional reactive power support in Regional Victoria. 	Increased maximum demand and/or reactive power consumption in regional Victoria.	2020 ISP/NSCAS did not identify this limitation as it is a localised issue.	Additional reactive support is unlikely to be a contestable project.

A2.8 Victoria system-wide

Limitations in the Victorian system

Limitation	Limitation type	Possible network solution	Trigger	2020 ISP/2020 NSCAS	Contestable project status
Insufficient demand to maintain minimum synchronous requirement	Monitored	Install synchronous condensers at strategic locations of the network	Decreasing minimum demand.	2020 ISP/NSCAS did not identify this limitation.	This is likely to be a contestable project.

A3. Approach to network limitation review

In assessing the impact of limitations, AEMO considers information from power system performance analysis and market simulations each year for the next 10 years regarding:

- The percentage N and N-1 loadings of transmission plant associated with the network loading limitation, based on the continuous and short-term ratings respectively.
- The load and energy at risk. Load at risk is the load shedding required to avoid the network limitation.
- Expected unserved energy (USE), which is the energy at risk after accounting for forced outages.
- Dispatch cost, which is the additional cost from constraining generation.
- Limitation cost, which is the total additional cost due to both constraining generators and expected USE.

Power system performance analysis uses conservative assumptions for demand, temperature, and wind speed to capture as many network limitations as possible for market simulation. For this reason, DSN performance analysis results (that is, the percentage loadings) can show more severe impacts than market simulations.

AEMO derives forecast transmission plant loadings using load flow simulations, and develops load flow base cases for these simulations using the following inputs:

- The 10% Probability of Exceedance (POE) terminal station demand for maximum demand base cases.
- Historical maximum power transfers for a high Victoria to New South Wales power transfer base case.
- Typical generation dispatch and interconnector flow patterns under the given operating conditions.
- The system normal operational configuration for the existing Victorian transmission network.
- Committed transmission network augmentation and generation projects, and other projects which AEMO considers necessary to maintain power system security or reliability during summer maximum demand.
- Standard continuous ratings and short-term ratings at 45°C and 0.6 m/s wind speed.
- Unless indicated, 15-minute ratings for transmission lines. Some transmission lines in Victoria are equipped with automatic load shedding schemes, which avoid overloading by disconnecting load blocks following a contingency. These schemes allow lines to operate to 5-minute ratings.
- Wind generation availability during maximum demand assumed to be 9.5% of the installed capacity.
- AEMO bases the market impact of each network limitation on probabilistic market simulations that apply:
- Weighted 50% POE and 10% POE maximum demand forecasts (weighted 70% and 30% respectively).
- Historical wind generation availability, and historical load profiles.
- Dynamic ratings based on historical temperature traces.
- Non-committed new and retired generation, consistent with the latest ISP.

For more information, see the Victorian Electricity Planning Approach¹²⁰.

¹²⁰ At https://www.aemo.com.au/-/media/Files/Electricity/NEM/Planning_and_Forecasting/Victorian_Transmission/2016/Victorian-Electricity-Planning-Approach.pdf

Abbreviations

Abbreviation	Term in full
AEMC	Australian Energy Market Commission
AEMO	Australian Energy Market Operator
AER	Australian Energy Regulator
APD	Alcoa Portland
BBTS	Berrybank Terminal Station
BESS	Battery energy storage system/s
BOM	Bureau of Meteorology
CBTS	Cranbourne Terminal Station
COAG	Council of Australian Governments
CRM	Customer relationship management
DER	Distributed energy resources
DNSP	Distribution Network Service Provider
DSN	Declared Shared Network
DSP	Demand-side participation
DTSO	Declared Transmission System Operator
EFCS	Emergency Frequency Control Scheme
EMT	Electromagnetic Transient
EPS	Eildon Power Station
ESB	Energy Security Board
ESCI	Electricity Sector Climate Information
ESOO	Electricity Statement of Opportunities
FCAS	Frequency control ancillary services
GFT	Generation fast tripping
GPG	Gas-powered generation
GW	Gigawatts
HILP	High impact, low probability

Abbreviation	Term in full
HSM	High-speed monitors
HVDC	High-voltage direct current
HWPS	Hazelwood Power Station
IBR	Inverter-based resources
IECS	Interconnector Emergency Control Scheme
IRM	Interim Reliability Measure
ISP	Integrated System Plan
JPB	Jurisdictional Planning Body
KTS	Keilor Terminal Station
kV	Kilovolts
LGC	Large-scale generation certificates
LOR	Lack of Reserve
MLF	Marginal loss factor
MLTS	Moorabool Terminal Station
MVA	Megavolt amperes
MVA _r	Megavolt amperes reactive
MW	Megawatts
MWh	Megawatt hours
NCIPAP	Network Capability Incentive Project Action Plan
NEL	National Electricity Law
NEM	National Electricity Market
NEMDE	National Electricity Market Dispatch Engine
NER	National Electricity Rules
NEVA	National Electricity Victoria Act
NMAS	Non-market ancillary services
NSCAS	Network Support and Control Ancillary Services
PACR	Project Assessment Conclusions Report
PADR	Project Assessment Draft Report
PMU	Phasor Measurement Unit
POE	Probability of exceedance
PSCR	Project Specification Consultation Report
PSFRR	Power System Frequency Risk Review

Abbreviation	Term in full
PV	Photovoltaic
RDP	Renewable Energy Zone Development Plan
RERT	Reliability and Emergency Reserve Trader
REZ	Renewable energy zone
RIS	Renewable Integration Study
RIT-T	Regulatory Investment Test for Transmission
ROCOF	Rate of change of frequency
ROTS	Rowville Terminal Station
RRN	Regional reference node
SCADA	Supervisory Control And Data Acquisition
SIPS	System Integrity Protection Scheme
SMTS	South Morang Terminal Station
SRAS	System restart ancillary services
SSSP	System Strength Service Provider
SVC	Static Var compensator
TNSP	Transmission network service provider
TRET	Tasmanian Renewable Energy Target
TSDF	Terminal station demand forecast
TTS	Thomastown Terminal Station
UFLS	Under-frequency load shedding
USE	Unserved energy
VAPR	Victorian Annual Planning Report
VNI	Victoria – New South Wales Interconnector
VPP	Virtual power plant
VRE	Variable renewable energy
VRET	Victorian Renewable Energy Target
VSAT	Voltage stability assessment tool
VSM	Virtual synchronous machine
VTL	Virtual transmission line
YPS	Yallourn Power Station